

TORREY C. BROWN, M.D.  
SECRETARY  
JOHN R. GRIFFIN  
DEPUTY SECRETARY



JAMES W. PECO  
DIRECTOR

STATE OF MARYLAND  
DEPARTMENT OF NATURAL RESOURCES  
**WATER RESOURCES ADMINISTRATION**  
TAWES STATE OFFICE BUILDING  
ANNAPOLIS, MARYLAND 21401

April 23, 1987

Mr. Louis H. Ege, Jr.  
Deputy Director  
Project Development Division  
State Highway Administration  
707 N. Calvert Street  
Baltimore, MD 21202

Re: WRA No. 86-PP-0900  
SHA No. HO-606-101-770  
Environmental Assessment for US 29  
Patuxent River Bridge to US 40  
Howard County

Dear Mr. Ege:

The Environmental Assessment document for the above referenced project has received necessary review by the Water Resources Administration's Waterway Permits Division and the Resource Protection Program. The Tidewater Administration, the Forest, Park and Wildlife Service and the Capital Programs Administration of the Department of Natural Resources were also provided with a copy of the subject document for their review and comments. As a result of the above review, the Administration has the following comments:

1. In accordance with COMAR 08.05.03.01 to 08.05.03.13, "Rules and Regulations Governing Construction on Non-Tidal Waters and Floodplains", Waterway Construction Permits are required for the proposed work where the course, current, or cross-section of the streams or their associated 100-year floodplain limits are to be impacted. More specifically, the main US 29 crossing of the Middle Patuxent River which requires new construction, the widening of the bridge over the Middle Patuxent River for Alternate B and C, and the tributaries which will be impacted by extension of the existing culverts and/or placement of new culverts to allow the construction of ramps or service roads require Waterway Construction Permits from this office. Some of the tributaries with limited drainage areas may be exempt from the requirements of a permit from the Administration under COMAR 08.05.03B.

Telephone: (301) 974-2265

TTY FOR DEAF: BALTIMORE 269-2609 WASHINGTON METRO 565-0450

Mr. Louis H. Ege, Jr.  
April 23, 1987  
Page Two

2. The proposed relocation of one of the streams at Hopkins-Gorman Road must be the last alternative considered. Moreover, our permit process will require advertisement of the Notice of Opportunity for Public Hearing provided that the subject relocation does not fall under the permit exemptions.
3. The Administration recommends the least impacted alternative to be considered in the selection of the final alternate.
4. In accordance with Section 8-1105 and 8-11A-05 of the Natural Resources Article, Annotated Code of Maryland, the project will require approval relative to sediment and erosion control and stormwater management requirements.
5. The Resource Protection Program found the project not to be inconsistent with their Program.

Enclosed is a copy of the comments received from the Tidewater Administration's Fisheries Division and the Coastal Resources Division on the subject Environmental Assessment.

Thank you for allowing us to comment on your project.

Sincerely,

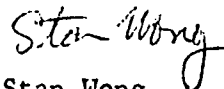

Stan Wong  
Chief, Waterway Permits Division

SW:MQT:das

Enclosures



RECEIVED<sup>3</sup>

APR 21 1987

TORREY C. BROWN, M.D.  
SECRETARY

WATERWAY PERMITS DIVISION  
WATER RESOURCES ADMINISTRATION  
DEPUTY SEC

STATE OF MARYLAND  
DEPARTMENT OF NATURAL RESOURCES  
TIDEWATER ADMINISTRATION  
TAWES STATE OFFICE BUILDING  
ANNAPOLIS 21401

March 5, 1987

MEMORANDUM

TO: M. Q. Taharian, Waterway Permits Division  
VIA: Elder Ghigliarelli, CRD  
FROM: Mike Slattery, CRD  
SUBJECT: Environmental Assessment, U.S. Route 29, Patuxent River Bridge  
to U.S. Route 40, Howard County, Maryland

This is in response to your memorandum dated February 3, 1987 requesting comments subsequent to our review of the Environmental Assessment. Having reviewed the document, the Coastal Resources Division has the following comments to offer:

1. Several of the wetlands identified in the EA are classified as palustrine, scrub-shrub wetlands with an A, or temporarily flooded, water regime. A condition of inundation for a more extended period of time is often necessary to support scrub-shrub type wetlands. We would appreciate documentation of field verification of wetlands classifications and modification.
2. Based on contours and intermittent waterways indicated on U.S.G.S. Quad maps, we believe that non-tidal wetlands that have not been identified may exist at certain points along the alignment (see attachment). We request that their existence or non-existence be verified in the field.
3. Projects, such as the U.S. Route 29 Improvements project, are evaluated only in terms of the immediate impacts with which they are associated. Cumulative impacts sustained by the natural environment extend beyond the construction limits of the project. A more comprehensive approach to assessing impacts associated with such work would more adequately address the concerns and efforts associated with the Chesapeake Bay Initiatives. More specifically, we are concerned about the downstream impacts to water quality and aquatic resources both on short term and long term scales. There are also a number of other highway projects proximal to this watershed which share the same impacts.
4. Treatment of wetland impacts in the EA is inadequate. Acreages have been provided, but that is the extent of the wetlands impact information provided for review. In order to fairly assess impacts to non-tidal wetlands, or any other facet of the natural environment, treatment must be given to

MEMORANDUM TO: M. Q. Taharian  
EA - Rte. 29  
3/5/87  
Page 2

4

floral and faunal composition, biotic communities, wildlife populations, and habitat-values. This information, along with a quantitative and technical treatment of specific impacts that might be expected to result from such construction should be included in a fair assessment of projected environmental impacts.

MS/sme

SEGMENT VII  
TO NORTH OF MARYLAND ROUTE 32

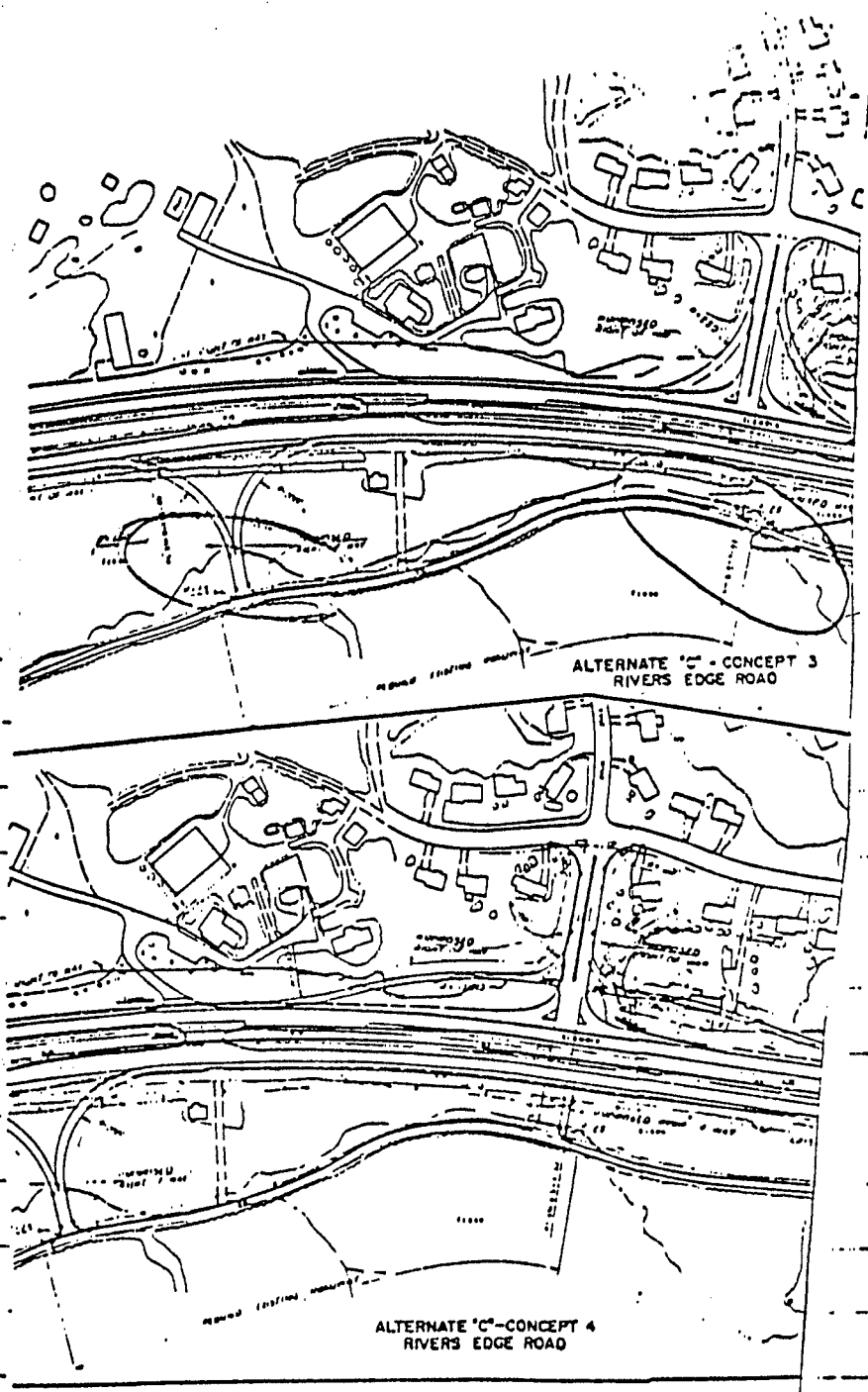

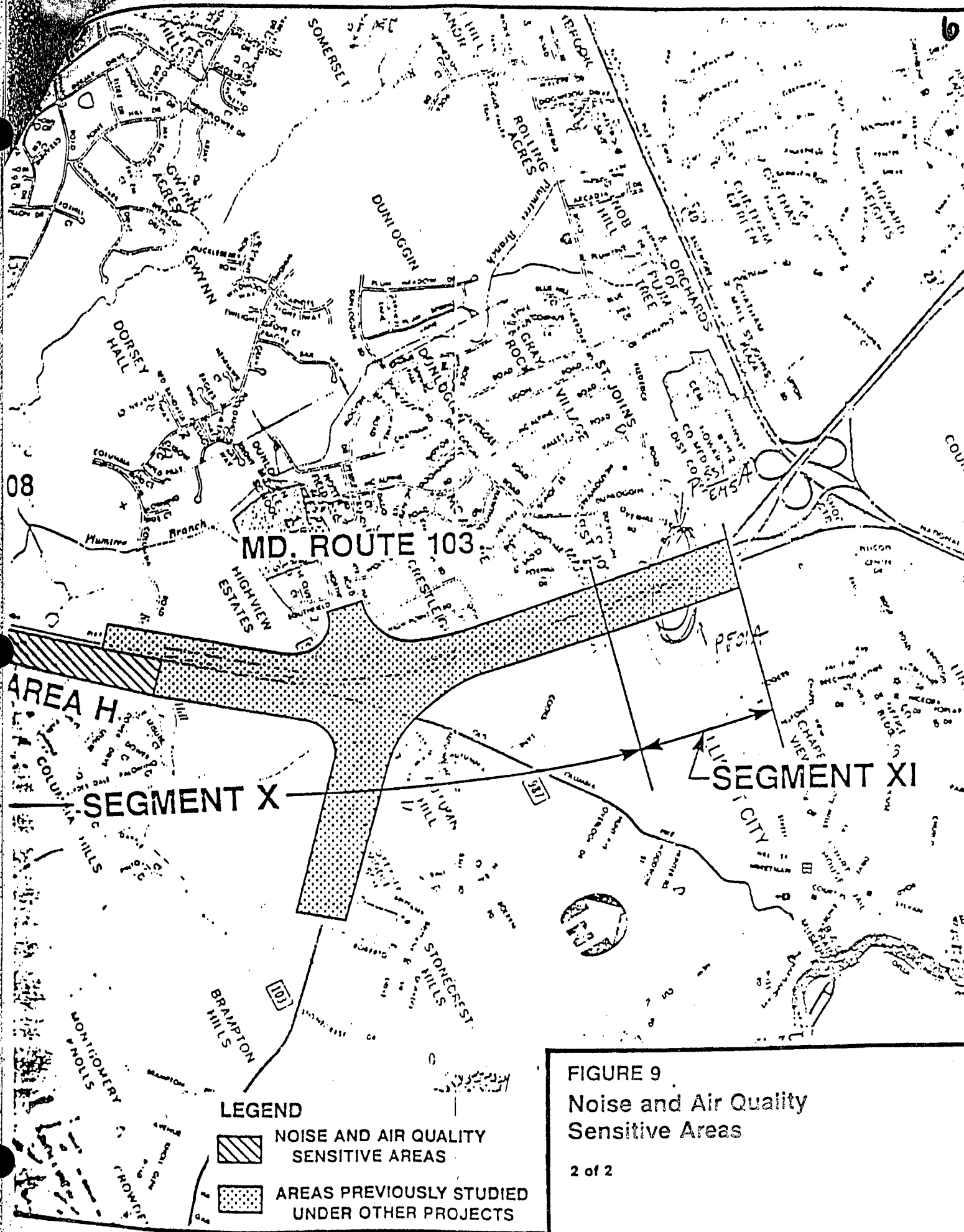
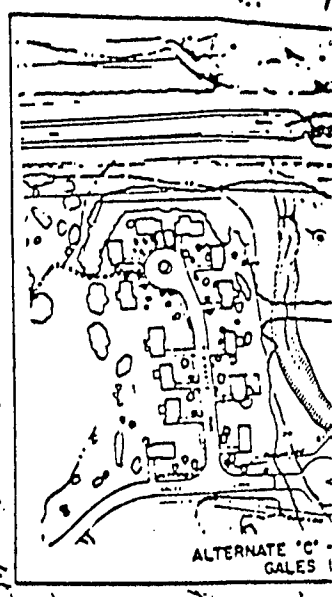
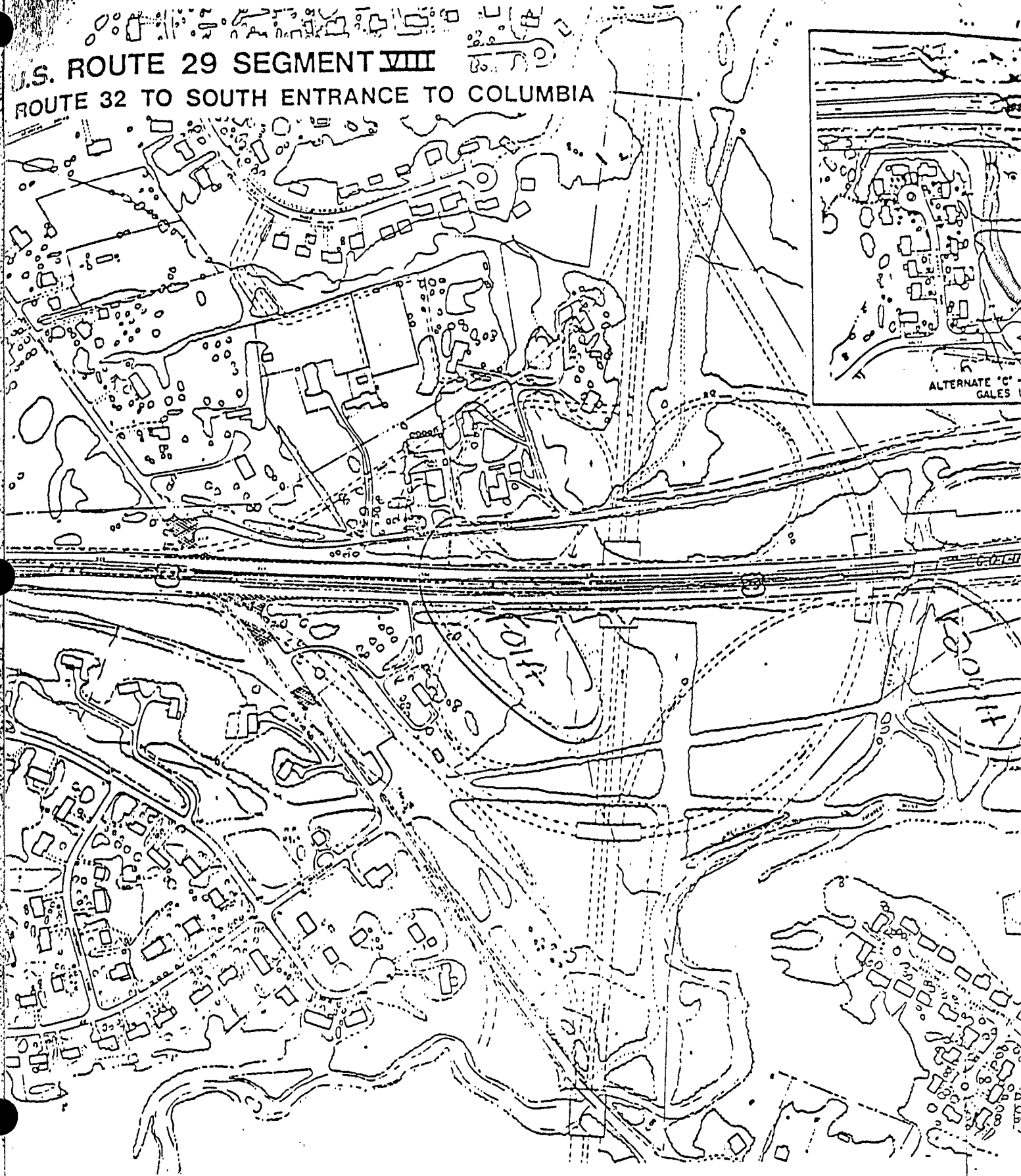

FIGURE 9  
 Noise and Air Quality  
 Sensitive Areas

*Brokenhead Phony*

**U.S. ROUTE 29 SEGMENT VIII**  
**ROUTE 32 TO SOUTH ENTRANCE TO COLUMBIA**





TORREY C. BROWN, M.D.  
SECRETARY

JOHN R. GRIFFIN  
DEPUTY SECRETARY

STATE OF MARYLAND  
DEPARTMENT OF NATURAL RESOURCES  
TIDEWATER ADMINISTRATION  
TAWES STATE OFFICE BUILDING  
ANNAPOLIS 21401

February 27, 1987

MEMORANDUM

TO: M.Q. Taherian  
Waterways Permit Division, WRA

FROM: W.P. Jensen, Director  
Fisheries Division

SUBJECT: Environmental Assessment (EA) for US Rte. 29 - Patuxent River Bridge  
to US Rte. 40, Howard County, MD. (86-PP-0900).

RECEIVED  
MAR 6 1987  
WATERWAY PERMITS DIVISION  
WATER RESOURCES ADMINISTRATION

Fisheries Division has reviewed the subject EA for Permit application (86-PP-0900) and has the following comments which were prepared by Bob Schueler of our Environmental Assessment Program. On June 13, 1986 Fisheries Division submitted comments to you for that portion of the US Rte. 29 expansion from I 495 to the Howard County line (Patuxent River Bridge). We also participated in the joint field reviews of Oct. 1 and Oct. 20, 1986.

1. The general thrust of comments (1) through (4) in Fisheries Division's report of June 13, 1986 is also applicable to the subject segment of Rte. 29. The proposed work involves expansion of an existing alignment, with additional lanes being created out of the median strip.

2. This segment of Rte. 29 traverses the headwaters of the Little Patuxent, Middle Patuxent and Hammond Branch watersheds. The key role played by these smaller, usually wooded, headwater streams in maintaining the quality of the downstream ecosystem has been well documented (Carter, 1986, attached). These contributions are vulnerable to modifications and alterations that decrease infiltration and evapotranspiration capacity and increase overland run-off. These effects, in addition to decreasing the allochthonous material fall-in which controls stream trophic webs, act to degrade the entire stream-river continuum, from headwaters to higher order stream sections. Observations made during the joint field reviews confirmed the picture of a small stream network currently of good quality and fairly diverse aquatic life.



3. The direct effects of the proposed work consists of:

(a) Increased erosion and sediment generation during the construction phases of the additional lanes and access facilities. This can be controlled by rigorous implementation of Best Management Practices (BMPs) for erosion and sediment control during these phases. This implies the strictest of monitoring and enforcement, however; a situation that does not normally fully prevail. It has been estimated that the effectiveness of these BMPs in actual practice is of the order of 70 percent (Shaver, 1986 - personal communication).

(b) Modification of access arrangements will involve alterations to access roads and lengthening of existing culverts. Some of the existing culvert situations represent at least a partial barrier to fish movements (as noted during the field reviews). Fisheries Division would like to see all new culverts depressed at least one foot below stream invert to facilitate fish passage. Existing culverts should ~~be retrofitted to facilitate fish passage either by culvert lowering or by cutting out a low flow channel in the base of the culvert wherever possible.~~

*infiltration*

(c) At present stormwater discharges from the existing impervious highway surface flow directly into the streams or into ditches emptying into the streams. Besides increased streambank erosion and sedimentation triggered by this accelerated run-off, there will be increased pollution inputs to the stream. Run-off from road surfaces containing heavy metals, chlorides, PCBs, grease and oil etc. can be deleterious to the quality of surface waters and consequently to the fish species involved (Shaheen, 1975). As part of the proposed work, Fisheries Division would like to see serious consideration of stormwater management retrofitting as part of the highway expansion to bring stormwater management measures into full conformity with COMAR .05.08.05.05. This would involve incorporation of measures for infiltration and flow attenuation (e.g. infiltration pits, etc.) rather than the current direct shunting of run-off into stream systems or into ditches emptying directly into stream systems.

4. The question of "indirect" or "secondary" effects was raised in the June 13, 1986 comments of Fisheries Division. By this is meant the degree to which development and suburbanization (with consequent impacts on aquatic habits) are related to, and caused (or at least facilitated) by the I-29 expansion. From the standpoint of aquatic resources and habitat this is the basic impact that underlies all the other changes. The EA does not satisfactorily address this problem; it is possible that SHA believes such a discussion is beyond the scope of an EA. Therefore, Fisheries Division concludes that preparation of a full-scale EIS is indicated.

5. Fisheries Division concurs with the consensus decisions relating to wetlands as outlined in the summaries of the Oct. 1 and Oct. 20, 1986 field reviews, which have been incorporated in the EA.

6. In summary, Fisheries Division concludes:

a. From the standpoint of fisheries resources and habitat Alternate A (No Build) is preferable, followed by Alternate B (widening but leaving all at-grade intersections intact). Alternate C (widening plus implementing access control by separating grades and/or installing service roads) is the least preferable, being the the most disruptive to existing aquatic life habitat as well as the most likely to facilitate secondary effects (additional development with consequent increases in impervious surface and non-point source pollution).

b. If Alternate C is chosen, the decision should be conditional on the following:

(1) rigorous implementation of erosion and sediment control BMPs during all construction stages in accordance with guidelines and specifications cited on pages IV-13 and IV-14 of the EA --- supported by adequate inspection and enforcement.

(2) as part of I-29 expansion the existing inadequate stormwater management system (i.e. direct discharge of polluted run-off to streams or ditches leading directly to streams) be retrofitted. Such retrofitting to emphasize infiltration measures eliminating direct discharge of polluted run-off from impervious highway surfaces.

(3) utilization of bridges in preference to culverts wherever possible.

(4) depression of all new culverts at least one foot below stream invert.

(5) retrofitting of existing culverts as necessary to facilitate fish passage either by depressing culverts at least one foot below stream invert or incorporating a low flow channel in the base of the existing culvert.

(6) provision of a "green belt" buffer at least 100' in width on each side of all stream.

c. The EA should be followed by production of a full DEIS, with particular attention to the problem of "secondary effects" as discussed in item 4. above.

REFERENCES CITED:

Carter, W.R. III, 1986. --"A discussion of small streams".  
Internal Position Paper, Maryland DNR, Oct. 1986.

Shaheen, D.C., 1975.--"Contributions of urban roadway usage  
to water pollution". EPA Environmental Protection  
Technology Series. EPA - 600/2-75-004. March 1975.

Attachment

cc: Project  
Journal  
Schueler  
Gougeon



APPENDIX 12A

TORREY C. BROWN, M.D.  
SECRETARY

JOHN R. GRIFFIN  
DEPUTY SECRETARY

STATE OF MARYLAND  
DEPARTMENT OF NATURAL RESOURCES  
TIDEWATER ADMINISTRATION  
TAWES STATE OFFICE BUILDING  
ANNAPOLIS 21401  
269-3061

June 11, 1986

MEMORANDUM

TO: Larry Lubbers, Environmental Review

FROM: Bob Schueler, Environmental Review *B.S.K.*

SUBJECT: Comments on SHA proposal to expand capacity of U.S. Route 29 from Four Corners (I-495) Montgomery County to the Howard County Line, MD

I understand that you and Mel Beaven will be analyzing the impact of this proposal on the Patuxent River and in Howard County. My review input covers only the segment from Four Corners to the Patuxent drainage - to be incorporated into whatever formal comments are produced by you and Mel. A site visit was made on June 7, 1986, and leads to the following comments.

(1) All the alternates being considered by SHA as part of its proposal involve improvement and expansion of an existing alignment. Generally speaking, Fisheries Division believes that if expansion of transportation facilities must be achieved it is preferable to expand an existing highway rather than penetrating relatively undisturbed areas with new alignments. From this perspective I am inclined to take a somewhat supportive stance as regards the subject proposal.

(2) Any comments should contain a statement that full and rigorous implementation and enforcement of erosion and sediment control measures during the construction stage is assumed. Appropriate standards and specifications are SHA's own "Standard Erosion and Sediment Control Procedures" as well as WRA standards and specifications. Fisheries Division keeps on repeating these platitudes endlessly but I believe it is necessary to continue doing this to keep the record clear and the pressure on.

(3) By the same token, Fisheries Division should repeat its standard concerns about stormwater management, at least insisting on full application of COMAR 05.08.05.05. The proposed work is not that massive an increase in the perturbations that have already taken place. There will be some increases

in imperious surface and traffic-induced polluted run-off. Fisheries Division should insist that the proposed work produce zero additional degradation from stormwater management operations.

(4) Improving I-29 in the project area will facilitate and accelerate the already rapid rate of development and suburbanization. This, in turn, will increase imperious surface, accelerate discharges of polluted run-off, and increase the already serious problem of stream channel erosion and sedimentation. Past Fisheries Division attempts to raise this problem of "secondary effects" have never drawn much SHA response. Nevertheless we should continue to make the point for the record and for consistency.

(5) Aside from the broad aspects touched on in items (1) through (4) above, Fisheries Division's specific concerns center around the three stream crossings in the subject Rte I-29 highway segment. These are Northwest Branch, Paint Branch, and an unnamed tributary to Little Paint Branch, whose situations are discussed separately below.

(6) Northwest Branch crossing - Rte I-29 presently crosses Northwest Branch over a box culvert/bridge that now accommodates six lanes of traffic - as much as is contemplated under any of the alternatives under consideration. Based on the information made available to us (SHA brochure for March 1, 1986, Alternatives Public Workshop) there appear to be no plans to alter this stream crossing in any major way. If this conclusion is in error we would like to be informed. There could be serious fisheries habitat concerns. Stormwater run-off (with its cargo of highway pollutants) enters directly into the stream at the bridge. Any upgrading of the highway should address this situation. Northwest Branch is class IV (recreational trout) water. Stocking of trout is conducted in Northwest Branch, mostly just below (and upstream of) the Randolph Road crossing. Some of the stocked trout occasionally make their way down to the I-29 crossing, although this means traversing a concrete dam (with its fully-silted impoundment) located just upstream of I-29.

(7) Paint Branch crossing - Rte I-29 crosses Paint Branch over a high, single arch bridge presently accommodating four lanes of traffic, as does most of I-95 north of New Hampshire Ave. While not spelled out in the material made available to us, it appears that the wide median strip would be ample to accommodate six lanes without widening the basic highway alignment. However, the median strip does not get carried across the existing bridge. Thus expansion to six lanes would involve substantial alteration and reconstruction of the bridge with the possibility of significant disruption to the stream habitat below. This problem will have to be addressed at the appropriate stage in the planning process. Stormwater run-off (with its cargo of highway pollutants) enters directly into the stream in the general vicinity of the bridge. Any upgrading of the highway or alteration of the existing bridge should address this problem preferably by providing infiltration options for stormwater run-off from the highway.

Paint Branch is class III (naturally reproducing) trout water, and the overall ecosystem supports a naturally-reproducing brown trout fishery with no stocking. Spawning has not been documented in the vicinity of the I-29 bridge crossing; it tends to be concentrated in the extreme upper Paint Branch ecosystem, especially the Good Hope tributary. However, adult brown trout up to 14 inches in length are regularly found in the stream in the vicinity of the bridge, both by trout fishermen and by DNR electrofishing (per Comm. Chas. Gougeon, Coldwater Fisheries Program). Actually adult brown trout have made their way down Paint Branch all the way to the I-495 Beltway. The Paint Branch crossing represents very valuable and very fragile fisheries habitat. It warrants the utmost in protection by maximized BMP's to offset any possible disruptions from highway upgrading.

(3) Unnamed tributary to Little Paint Branch - At the present time a very small (2-3 feet wide) headwater tributary flows under Rte I-29 in a 60" corrugated metal pipe conduit a short distance north of Greencastle. The Little Paint Branch system is Class I (warmwater fisheries). Shortly after passing under Rte I-29, the tributary enters the "wet pond" of the Regional Stormwater Management Pond located approximately 400 yards east of the highway.

There appears to be ample room in the median strip to accommodate two more lanes without widening the existing highway alignment; if that alternate is to be seriously considered. Pending receipt of more information it does not appear that any likely highway upgrading will adversely impact the unnamed tributary providing the precautions outlined in items (1) through (4) are applied.

(9) In summary, the proposed increase in highway capacity concentrates on moderate alteration of an established alignment. With proper coordinated planning and strict enforcement of erosion and sediment control measures, adverse impacts can be minimized. Some retro fitting of stormwater management through provision of infiltration-type measures should receive serious consideration. From the fisheries habitat standpoint the stream crossings are the sensitive aspect, particularly the crossing of Paint Branch with its Class III water. It appears that the existing bridge may have to undergo substantial alteration, putting the valuable and fragile stream habitat at risk. This point of possible bridge replacement or alteration relative to Paint Branch should be clarified by SHA as soon as possible.

BS/lk

cc: Project  
Journal  
Guide  
Schueler  
Gougeon

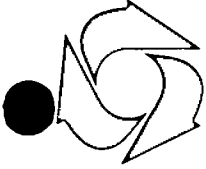

# Maryland Department of Transportation

State Highway Administration

William K. Hellmann  
Secretary

Hal Kassoff  
Administrator

15

PROJECT  
DEVELOPMENT  
DIVISION  
MAR 6 9 31 AM '87

## MEMORANDUM

TO: Mr. Louis H. Ege, Jr., Deputy Director  
Division of Project Development

FROM: *for* J. L. White, P.E., Chief  
Bureau of Planning and Program Development *J. L. White*

SUBJECT: Howard County  
US Route 29  
Environmental Assessment

This office has reviewed the subject Environmental Assessment and offers the following comments for consideration.

Page I-1 of the document provides a list of interchanges developed as individual projects. The Johns Hopkins/Gorman Road interchange should be added, indicating that preliminary studies are underway.

A list of recommendations begins on page I-22 and is continued on page I-32, separated by several maps. This creates confusion for the reader, especially since another listing, identifying community facilities is provided on page I-31.

The second complete paragraph on Page II-2 mentions various improvements that provide additional capacity on US Route 29. Omitted from these improvements are the preliminary studies for the US Route 29/Johns Hopkins/Gorman Road interchange.

The last paragraph on page II-2 references the inclusion of improvements, at the US Route 29/Maryland Route 103 interchange, in the 1982 Highway Needs Inventory (HNI). It should be mentioned that these improvements are included in the revised 1984 HNI. Reference of these interchange improvement's inclusion in the 1984-1989 Consolidated Transportation Program (CTP) is made at the top of page II-3. The construction of a new interchange at US Route 29/Maryland Route 103 is included in the 1987-1992 CTP, with construction scheduled to begin in Fiscal Year 1989.

My telephone number is 1127

16  
Mr. Louis H. Ege, Jr.

Page 2

Under Alternate VIII-C-2 on page III-2 improvements are identified at Pepple Drive. In the next paragraph reference is made to Pepple Road. Pepple Road is again referenced several times on pages III-10 and III-11.

A description of alternates is provided in section III. On page III-4 in the description of Alternate VI-C-1 Service Road 'A' is not mentioned. At the Design Public Hearing (February 17, 1987) it was indicated that under this alternate Service Road 'A' would extend south from Maryland Route 216 on the east side of US Route 29.

In the description of Alternate VIII-C-2 (page III-10) under key points it should be mentioned that this alternate requires the crossing of a minor tributary.

Thank you for the opportunity to review this document. If you have any questions regarding our comments, please contact John Bruck or Dennis Yoder on extension 1127.

cc: Mr. John D. Bruck  
Mr. Randy Aldrich





MARYLAND

DEPARTMENT OF STATE PLANNING

301 W. PRESTON STREET  
BALTIMORE, MARYLAND 21201-2365

WILLIAM DONALD SCHAEFER  
GOVERNOR

CONSTANCE LIEDER  
SECRETARY

January 29, 1987

*Shoof*  
*Please file in office copy of EA*

FEB 2 1 03 PM '87

PROJECT  
DEVELOPMENT  
DIVISION

Mr. Neil J. Pedersen, Director  
Office of Planning & Prel. Engr.  
State Highway Administration  
707 North Calvert Street  
Baltimore, Maryland 21202

State Application Identifier: MD870128-007

State Clearinghouse Contact: Samuel Baker

RE: EA - US Rte 29, Patuxent River Bridge to  
US Rte 40 (HO 606-101-770)

Dear Mr. Pedersen:

This is to acknowledge receipt of the referenced subject. We will provide notice to State and local public officials of the subject via the Intergovernmental Monitor.

Thank you for your cooperation.

Sincerely,

Guy W. Hager  
Maryland State Clearinghouse  
for Intergovernmental Assistance

GWH/jp

cc: Daryl Rawlings (RPC)

RECEIVED

FEB 2 1987

DIRECTOR, OFFICE OF  
PLANNING & PRELIMINARY ENGINEERING  
TELEPHONE: 301-225-4490  
TTY for Deaf: 301-383-7555  
OFFICE OF STATE CLEARINGHOUSE

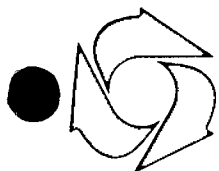

**Maryland Department of Transportation**

State Highway Administration

**William K. Hellmann**  
Secretary

**Hal Kassoff**  
Administrator

January 20, 1987

Contract No. HO 606-101-770  
U.S. Route 29 Patuxent River Bridge to  
U.S. Route 40  
Howard County

ENVIRONMENTAL ASSESSMENT

Transmitted for your review and comment is a copy of the subject document. The document has been prepared in accordance with the CEQ Regulations, DOT Order 5610.1c, and the Federal Aid Highway Program Manual, Volume 7, Chapter 7, Section 2.

You are requested to provide comments on or before March 3, 1987 to:

Mr. Louis H. Ege, Jr.  
Deputy Director  
Project Development Division (Room 310)  
State Highway Administration  
707 North Calvert Street  
Baltimore, Maryland 21202

All responses will be considered in developing the final document.

Very truly yours,

*Neil J. Pedersen*

Neil J. Pedersen, Director  
Office of Planning and  
Preliminary Engineering

NJP:tlh

- cc: Mr. Bob Myers
- Mr. Louis H. Ege, Jr.
- Ms. Cynthia D. Simpson
- Mr. Randy Aldrich

My telephone number is 333-1110

DISTRIBUTION LIST

FEDERAL AGENCIES

U.S. Environmental Protection Agency  
Region III  
Mr. Richard V. Pepino, Chief  
NEPA Compliance Section  
841 Chestnut Street  
Philadelphia, Pennsylvania 19107  
ATTN: Mr. Jeffrey Alper

U.S. Army Corps of Engineers  
Ms. Mary Dircks  
P.O. Box 1715  
Baltimore, Maryland 21203

U.S. Fish and Wildlife Service  
Ms. Diane Eckles  
1825 Virginia Street  
Annapolis, Maryland 21401

Mr. Paul Giordano  
Regional Director  
Federal Emergency Management Agency  
Liberty Square Building  
105 South 7th Street  
Philadelphia, Pennsylvania 19106

STATE CLEARINGHOUSE

Mr. Guy Hager, Director  
Intergovernmental Assistance Clearinghouse  
Department of State Planning  
301 West Preston Street  
Baltimore, Maryland 21201

STATE AGENCIES

Ms. Katherine Fay  
State Depository Distribution Center  
Enoch Pratt Free Library  
400 Cathedral Street  
Baltimore, Maryland 21201

Mr. Kirk Cover  
Water Resources Administration  
Department of Natural Resources  
Tawes State Office Building  
Annapolis, Maryland 21401

COUNTY AGENCIES

Mr. George F. Neimeyer, Director  
Howard County Department of Public Works  
3430 Courthouse Drive  
Ellicott City, Maryland 21043

Mr. Thomas G. Harris, Jr., Director  
Howard County Office of Planning & Zoning  
3430 Courthouse Drive  
Ellicott City, Maryland 21043

ELECTED OFFICIALS

The Honorable Elizabeth Bobo  
County Executive  
Howard County  
3430 Courthouse Drive  
Ellicott City, Maryland 21043

The Honorable Angela Beltram  
Member - County Council  
Howard County  
3430 Courthouse Drive  
Ellicott City, Maryland 21043

The Honorable Charles C. Feaga  
Member - County Council  
Howard County  
3430 Courthouse Drive  
Ellicott City, Maryland 21043

The Honorable C. Vernon Gray  
Chairman - County Council  
Howard County  
3430 Courthouse Drive  
Ellicott City, Maryland 21043

The Honorable Ruth U. Keeton  
Member - County Council  
Howard County  
3430 Courthouse Drive  
Ellicott City, Maryland 21043

The Honorable Shane Pendergrass  
Vice Chairman - County Council  
Howard County  
3430 Courthouse Drive  
Ellicott City, Maryland 21043

The Honorable Thomas M. Yeager  
Maryland State Senator  
William S. James Senate Office Building  
110 College Avenue  
Annapolis, Maryland 21401-1991

The Honorable J. Kasemeyer  
Maryland State Senator  
William S. James Senate Office Building  
110 College Avenue  
Annapolis, Maryland 21401-1991

ELECTED OFFICIALS (cont'd)

The Honorable Virginia M. Thomas  
Member - Maryland House of Delegates  
T. H. Lowe House Office Building  
6 Governor Bladen Boulevard  
Annapolis, Maryland 21401-1991

The Honorable William C. Bevan  
Member - Maryland House of Delegates  
T. H. Lowe House Office Building  
6 Governor Bladen Boulevard  
Annapolis, Maryland 21401-1991

The Honorable Susan R. Buswell  
Member - Maryland House of Delegates  
T. H. Lowe House Office Building  
6 Governor Bladen Boulevard  
Annapolis, Maryland 21401-1991

The Honorable Robert L. Flanagan  
Member - Maryland House of Delegates  
T. H. Lowe House Office Building  
6 Governor Bladen Boulevard  
Annapolis, Maryland 21401-1991

The Honorable Robert H. Kittleman  
Member - Maryland House of Delegates  
T. H. Lowe House Office Building  
Annapolis, Maryland 21401-1991

OTHER

Mr. Ronald Laske, President  
Allview/Arrowhead Civic Association  
6514 Belleview Drive  
Columbia, Maryland 21046

Mr. Denny Stam, President  
Columbia Hills - Meadowbrook Farm  
Community Association  
4669 Dapple Court  
Ellicott City, Maryland 21043

Ms. Gail Williams, President  
Hammond Village Citizens Association  
P.O. Box 84  
Simpsonville, Maryland 21150

OTHER (cont'd)

Ms. Susan Gladhill  
c/o Warfield Range Citizens Association  
10525 Patuxent Ridge Way  
Laurel, Maryland 20707

Mr. James M. Tordella, President  
Maryland Association of Bicycle Organizations  
10353 Maypole Way  
Columbia, Maryland 21044

Mr. Hans Marchand, President  
Harper's Choice Community Association, Inc.  
Kahler Hall, Joseph Square  
Columbia, Maryland 21044

Ms. Ethel Koontz, Correspondence Secretary  
Old Columbia Pike Preservation Association, Inc.  
3850 Old Columbia Pike  
Ellicott City, Maryland 21043

Mr. John F. Liparini, President  
Brantly Development Corporation  
5501 Twin Knolls  
Suite 105  
Columbia, Maryland 21045

# ENVIRONMENTAL ASSESSMENT

## U.S. Route 29

Patuxent River Bridge to U.S. Route 40  
Howard County, Maryland

Contract Number HO 606-101-770

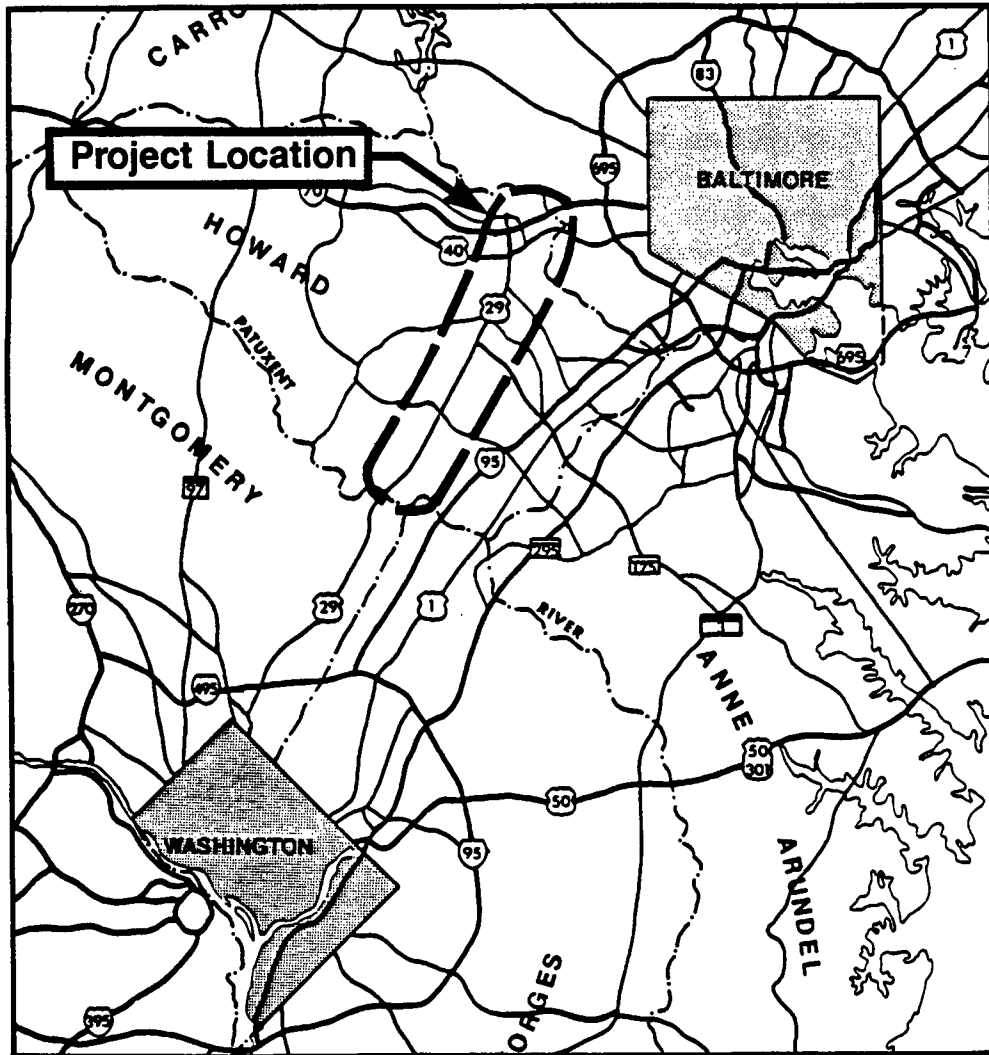

U.S. Department of Transportation  
Federal Highway Administration

Maryland Department of Transportation  
State Highway Administration

Report Number: FHWA-MD-EA-87-01-D

Federal Highway Administration  
Region III

U.S. Route 29  
from Patuxent River Bridge  
to U.S. Route 40  
Howard County, Maryland

ADMINISTRATIVE ACTION

ENVIRONMENTAL ASSESSMENT

U.S. Department of Transportation  
Federal Highway Administration  
and  
State of Maryland  
Department of Transportation  
State Highway Administration

SUBMITTED PURSUANT TO: 42. U.S.C. 4332 (2) (C)  
CEQ REGULATIONS (40 CFR 1500 et seq)

1/12/87  
Date

Neil J. Pedersen  
Neil J. Pedersen, Director  
Office of Planning and  
Preliminary Engineering  
Maryland State Highway Administration

1/12/87  
Date

[Signature]  
Federal Highway Administration  
Division Federal Highway  
Administrator



TABLE OF CONTENTS

	<u>PAGE NUMBER</u>
SUMMARY	S-1
ENVIRONMENTAL ASSESSMENT FORM	EAF-1
I. <u>DESCRIPTION OF PROPOSED ACTION</u>	I-1
A. PROJECT LOCATION	I-1
B. PROJECT DESCRIPTION	I-1
C. <u>DESCRIPTION OF EXISTING ENVIRONMENT</u>	I-7
1. Land Use and Planning	I-7
2. Population and Housing Characteristics	I-13
3. Neighborhood Characteristics	I-22
4. Community Facilities and Services	I-22
a. Transportation System	I-22
b. Emergency Services	I-32
c. Health Care Facilities	I-33
d. Educational Facilities	I-33
e. Religious Facilities	I-34
f. Recreation Parks	I-34
g. Miscellaneous Facilities	I-35
5. Historic and Archeological Resources	I-35
6. Economic Characteristics	I-36
a. Economic Activity	I-36
b. Employment and Income	I-37
c. Taxes and Revenue	I-37
7. Natural Environment	I-37
a. Surface Water	I-37
b. Groundwater	I-46
c. Wetlands	I-46
d. Floodplains	I-49
e. Vegetation	I-49
f. Wildlife	I-51
g. Farmland	I-52
h. Visual Environment	I-52
8. Existing Noise Levels	I-53
9. Existing Air Quality	I-53
II. <u>NEED FOR THE PROJECT</u>	II-1
A. PURPOSE	II-1
B. PROJECT BACKGROUND	II-1
C. EXISTING AND PROJECTED TRAFFIC CONDITIONS	II-3
D. EXISTING AND PROJECTED SAFETY CONDITIONS	II-6
III. <u>ALTERNATES CONSIDERED</u>	III-1
A. ALTERNATES NO LONGER BEING CONSIDERED	III-1
B. ALTERNATES CONSIDERED	III-2

26

TABLE OF CONTENTS  
CONTINUED

	<u>PAGE NUMBER</u>
IV. <u>ENVIRONMENTAL IMPACTS</u>	IV-1
A. Land Use and Planning Impacts	IV-1
B. Displacements	IV-2
C. Neighborhoods	IV-4
D. Community Facilities and Services	IV-6
1. Transportation	IV-6
2. Emergency Services	IV-6
3. Health Care Facilities	IV-7
4. Educational Facilities	IV-7
5. Religious Facilities	IV-8
6. Parks	IV-8
E. Historic and Archeological Resources	IV-9
F. Economic Impacts	IV-9
1. Economic Activity	IV-9
2. Taxes and Revenue	IV-10
G. Natural Environment	IV-11
1. Surface Water	IV-11
2. Groundwater	IV-15
3. Wetlands	IV-15
4. Floodplains	IV-18
5. Vegetation	IV-21
6. Wildlife	IV-21
7. Farmland	IV-21
8. Visual Environment	IV-23
H. Noise	IV-24
I. Air Quality	IV-30
V. <u>COMMENTS AND COORDINATION</u>	V-1
A. Public Involvement	V-1
B. Agency Involvement	V-1
VI. <u>APPENDIX--TRAFFIC DATA</u>	VI-1

LIST OF FIGURES

<u>FIGURE NUMBER</u>	<u>FIGURE TITLE</u>	<u>PAGE NUMBER</u>
1	Location Map	I-2
2	Study Area	I-3-5
3	Existing Land Use	I-9-11
4	Areas Designated for Land Use Change	I-15-17
5	Zonal Boundary Map	I-19
6	Neighborhoods Map	I-23-25
7	Community Facility and Services Map	I-27-29
8	Commuter Trips per Day	I-39
9	Noise and Air Quality Sensitive Areas	I-55-57
10	Noise and Air Quality Sensitive Area A	I-59
11	Noise and Air Quality Sensitive Area B	I-60
12	Noise and Air Quality Sensitive Area C	I-61
13	Noise and Air Quality Sensitive Area D	I-62
14	Noise and Air Quality Sensitive Area E	I-63
15	Noise and Air Quality Sensitive Area F	I-64
16	Noise and Air Quality Sensitive Area G	I-65
17	Noise and Air Quality Sensitive Area H	I-66
	Detailed Alternates Mapping, (Sheet 1 of 8)	III-13
	Detailed Alternates Mapping, (Sheet 2 of 8)	III-15
	Detailed Alternates Mapping, (Sheet 3 of 8)	III-17
	Detailed Alternates Mapping, (Sheet 4 of 8)	III-19
	Detailed Alternates Mapping, (Sheet 5 of 8)	III-21
	Detailed Alternates Mapping, (Sheet 6 of 8)	III-23
	Detailed Alternates Mapping, (Sheet 7 of 8)	III-25
	Detailed Alternates Mapping, (Sheet 8 of 8)	III-27
	Typical Sections--U.S. Route 29--Highway	III-29
	Typical Sections--U.S. Route 29--Collector and Local Streets	III-31



LIST OF TABLES

<u>TABLE NUMBER</u>	<u>TABLE TITLE</u>	<u>PAGE NUMBER</u>
1	Land Use Development	I-8
2	1980 Population Characteristics	I-14
3	1980 Household Characteristics	I-21
4	Zonal Population Characteristics and Projections	I-21
5	Employment Characteristics and Projections	I-38
6	Commuter Patterns from U.S. Route 29 Corridor	I-40
7	U.S. Route 29 Streams Information	I-41
8	Study Area Water Quality Data	I-43
9	Maryland Water Use Classification for U.S. Route 29 Associated Tributaries	I-45
10	U.S. Route 29 Wetlands	I-47
11	Vegetative Habitat	I-50
12	Existing Noise Levels from Noise Monitoring Sites	I-54
13	Noise Modeling Sites	I-67
14	1985 Traffic Data	II-4
15	Design Year 2015 Traffic Data	II-4
16	Accident Rates by Accident Severity, 1983-1985	II-7
17	Accident Rates by Collision Type, 1983-1985	II-7
18	High Accident Locations - Highway Sections, 1983-1985	II-8
19	High Accident Locations - Intersections, 1983-1985	II-8
20	Displacements	IV-3
21	"Alternate C" Concepts - Effects on Neighborhoods	IV-5
22	Wetland Impacts	IV-16
23	Floodplain Impacts	IV-19
24	Land Cover Impacts	IV-22
25	Worst-Case Projected Noise Levels	IV-25
26	Number of Receptors Impacted	IV-27
27	Number of Receptors benefiting from Noise Barriers	IV-28
28	Noise Barrier Dimensions and Costs to Mitigate Noise Impacts	IV-29
29	Air Quality Modeling Sites	IV-31
30	Projected Worst-Case Carbon Monoxide Concentrations	IV-32

29

SUMMARY

1. ADMINISTRATIVE ACTION

- ( ) Environmental Impact Statement
- (X) Environmental Assessment
- ( ) Finding of No Significant Impact
- ( ) Section 4(f) Involvement

2. ADDITIONAL INFORMATION

Additional information concerning this project may be obtained by contacting:

Mr. Edward Terry  
 Field Operations Engineer  
 Federal Highway Administration  
 The Rotunda-Suite 220  
 711 West 40th Street  
 Baltimore, MD 21211  
 PHONE: (301) 962-4010  
 HOURS: 7:45 a.m. to 4:15 p.m.

Mr. Louis H. Ege, Jr.  
 Deputy Director, Office of Planning  
 and Preliminary Engineering  
 State Highway Administration,  
 707 North Calvert Street, Room 310  
 Baltimore, MD 21202  
 PHONE: (301) 333-1130  
 HOURS: 8:15 a.m. to 4:15 p.m.

3. DESCRIPTION OF ACTION

The project proposes to provide additional, safe, and efficient capacity on U.S. Route 29 between the Patuxent River bridge and U.S. Route 40 in Howard County, Maryland. The proposed improvements include adding a northbound and southbound lane, or adding the lanes and controlling access by constructing grade separations and/or service roads.

4. ALTERNATE DESCRIPTION

The State Highway Administration has considered three alternates. These alternates were presented at an Alternates Public Workshop on February 8, 1986, at Hammond High School in Columbia. These three alternates were identified for evaluation of environmental and engineering studies. Each alternate was evaluated in each of six segments, numbered VI through XI, which divided the entire 11.69 mile segment.

Alternate A is the No Build Alternate, consisting of the existing highway with at-grade intersections. No improvements to U.S. Route 29 would occur. Alternate B includes widening the corridor within the median from four to six lanes and leaving all at-grade intersections (other than those currently under development) and other access points intact. In addition to adding lanes, Alternate C includes implementing access control by separating grades and/or installing service roads.

Several concepts have been included for study under Alternate C. These multiple concepts were developed to address different options at several intersections of U.S. Route 29. Section III presents each alternate and concept.

30

## 5. SUMMARY OF IMPACTS

The following table summarizes the impacts of each alternate within various categories addressed in the environmental studies.

SUMMARY OF IMPACTS TABLE

<u>IMPACT CATEGORY</u>	<u>ALTERNATE A</u>	<u>ALTERNATE B</u>	<u>ALTERNATE C</u>
Traffic	Does not meet future transportation demand.	Does not meet future transportation demand.	Provides acceptable future traffic flow.
Safety	Increases the number of accidents.	Limited reduction in the number of accidents.	Substantial reduction in the number of accidents
Total Cost	None	\$9.544 million.	\$17.239 million <sup>1</sup> .
Land Use and Planning	Incompatible with land use plans.	Incompatible with land use plans	Compatible with land use plans.
Displacements	No displacements	No displacements.	A maximum loss of six residences, one residential/commercial structure and one commercial structure if all worst-case concepts are selected.
Neighborhood and Social Groups	Provides accessibility to all neighborhoods, but adds cutthrough traffic on neighborhood streets. Unsafe conditions accessing U.S. Route 29.	Provides accessibility to neighborhoods. Unsafe conditions accessing U.S. Route 29.	Changes the access to neighborhoods, but provides safe access.
Community Facilities	Hampers emergency vehicle travel due to severe congestion.	Hampers emergency vehicle travel due to severe congestion.	Changes access for emergency services while improving response time on U.S. Route 29.
Surface Water	No impact.	Potential short-term erosion impact at Middle Patuxent River during construction.	Short-term erosion impacts during construction at tributaries of Patuxent River, Hammond Branch, Middle Patuxent River. One stream relocation of approximately 610 feet.
Groundwater	No impact.	No impact.	No impact.
Wetlands	No wetlands impacted.	Approximately 0.006 acres of wetlands destroyed along Middle Patuxent River.	A maximum of approximately 1.23 acres of wetlands destroyed if all worst-case concepts are selected.
Floodplains	No impact.	Maximum of approximately 0.806 acres of floodplains impacted.	Maximum of approximately 2.006 acres of floodplains impacted if all worst-case concepts are selected.
Vegetation	No impact.	No impact.	A maximum loss of approximately 16.4 acres of natural vegetation if all worst-case concepts are selected.
Threatened and Endangered Species	No impact.	No impact.	No impact.

SUMMARY OF IMPACTS TABLE  
(CONTINUED)

<u>IMPACT CATEGORY</u>	<u>ALTERNATE A</u>	<u>ALTERNATE B</u>	<u>ALTERNATE C</u>
Prime and Statewide Farmland	No impact.	No impact.	Maximum of approximately 5.4 acres of prime farmland destroyed if worst-case concepts selected.
Noise	No impact.	31 receptors impacted in excess of the NAC before abatement.	66 receptors impacted in excess of the NAC before abatement.
Air	Carbon monoxide concentrations exceeding the NAAQS by 2015.	No violations of National or State Ambient Air Quality Standards.	No violations of National or State Ambient Air Quality Standards.

1For the most costly concept in each segment, over and above roadway widening costs of Alternate B.

ENVIRONMENTAL ASSESSMENT FORM

The following Environmental Assessment Form (EAF) is a requirement of the Maryland Environmental Policy Act and Maryland Department of Transportation Order 11.01.06.02. It was completed to serve as a guide to the studies presented in this Environmental Assessment document. Its use is in keeping with the provisions of 1500.4(k) and 1506.2 and .6 of the Council of Environmental Quality Regulations, effective July 31, 1979, which recommend that duplication of Federal, State, and Local procedures be integrated into a single process.

The checklist of the EAF identified specific areas of the natural and social-economic environment considered while preparing this Environmental Assessment. It highlighted potential impacts, beneficial or adverse, that the action may incur. The "No" column indicated that during the scoping and early coordination processes, that specific area of the environment was not identified to be within the project area or would not be impacted by the proposed action.



ENVIRONMENTAL ASSESSMENT FORM

33

	<u>YES</u>	<u>NO</u>	<u>COMMENTS</u>
A. Land Use Considerations			
1. Will the action be within the 100 year flood plain?	<u>X</u>	_____	____ IV-18 ____
2. Will the action require a permit for construction or alteration within the 50 year flood plain?	_____	<u>X</u>	_____
3. Will the action require a permit for dredging, filling, draining or alteration of a wetland?	<u>X</u>	_____	____ IV-21 ____
4. Will the action require a permit for the construction or operation of facilities for solid waste disposal including dredge and excavation spoil?	_____	<u>X</u>	_____
5. Will the action occur on slopes exceeding 15%?	_____	<u>X</u>	_____
6. Will the action require a grading plan or a sediment control permit?	<u>X</u>	_____	____ IV-11 ____
7. Will the action require a mining permit for deep or surface mining?	_____	<u>X</u>	_____
8. Will the action require a permit for drilling a gas or oil well?	_____	<u>X</u>	_____
9. Will the action require a permit for airport construction?	_____	<u>X</u>	_____
10. Will the action require a permit for the crossing of the Potomac River by conduits, cables or other like devices?	_____	<u>X</u>	_____
11. Will the action affect the use of a public recreation area, park, forest, wildlife management area, scenic river or wildland?	_____	<u>X</u>	_____

12. Will the action affect the use of any natural or man-made features that are unique to the county, state, or nation?          X         

13. Will the action affect the use of an archeological or historical site or structure?          X         

B. Water Use Considerations

14. Will the action require a permit for the change of the course, current, or cross-section of a stream or other body of water?   X            IV-11  

15. Will the action require the construction, alteration, or removal of a dam, reservoir, or waterway obstruction?          X         

16. Will the action change the overland flow of storm water or reduce the absorption capacity of the ground?   X            IV-11  

17. Will the action require a permit for the drilling of a water well?          X         

18. Will the action require a permit for water appropriation?          X         

19. Will the action require a permit for the construction and operation of facilities for treatment or distribution of water?          X         

20. Will the project require a permit for the construction and operation of facilities for sewage treatment and/or land disposal of liquid waste derivatives?          X

YES NO

COMMENTS

23

21. Will the action result in any discharge into surface or sub-surface water?

X       

IV-11

22. If so, will the discharge affect ambient water quality parameters and/or require a discharge permit?

       X

C. Air Use Considerations

23. Will the action result in any discharge into the air?

X       

IV-30

24. If so, will the discharge affect ambient air quality parameters or produce a disagreeable odor?

X       

IV-30

25. Will the action generate additional noise which differs in character or level from present conditions?

X       

IV-24

26. Will the action preclude future use of related air space?

       X

27. Will the action generate any radiological, electrical, magnetic, or light influences?

       X

D. Plants and Animals

28. Will the action cause the disturbance, reduction or loss of any rare, unique or valuable plant or animal?

       X

29. Will the action result in the significant reduction or loss of any fish or wildlife habitats?

       X

30. Will the action require a permit for the use of pesticides, herbicides or other biological, chemical or radiological control agents?

       X

E. Socio-Economic

	<u>YES</u>	<u>NO</u>	<u>COMMENTS</u>
31. Will the action result in a pre-emption or division of properties or impair their economic use?	<u>X</u>	<u>      </u>	<u>IV-2</u>
32. Will the action cause relocation of activities, structures, or result in a change in the population density or distribution?	<u>X</u>	<u>      </u>	<u>IV-2</u>
33. Will the action alter land values?	<u>X</u>	<u>      </u>	<u>IV-9</u>
34. Will the action affect traffic flow and volume?	<u>X</u>	<u>      </u>	<u>II-3, IV-6</u>
35. Will the action affect the production, extraction, harvest or potential use of a scarce or economically important resource?	<u>      </u>	<u>X</u>	<u>      </u>
36. Will the action require a license to construct a sawmill or other plant for the manufacture of forest products?	<u>      </u>	<u>X</u>	<u>      </u>
37. Is the action in accord with federal, state, regional and local comprehensive or functional plans-- including zoning?	<u>X</u>	<u>      </u>	<u>IV-1</u>
38. Will the action affect the employment opportunities for persons in the area?	<u>X</u>	<u>      </u>	<u>IV-9</u>
39. Will the action affect the ability of the area to attract new sources of tax revenue?	<u>X</u>	<u>      </u>	<u>IV-9</u>
40. Will the action discourage present sources of tax revenue from remaining in the area, or affirmatively encourage them to relocate elsewhere?	<u>      </u>	<u>X</u>	<u>      </u>

	<u>YES</u>	<u>NO</u>	<u>COMMENTS</u>
41. Will the action affect the ability of the area to attract tourism?	_____	<u>X</u>	_____
<b>F. Other Considerations</b>			
42. Could the action endanger the public health, safety or welfare?	_____	<u>X</u>	_____
43. Could the action be eliminated without deleterious affects to the public health, safety, welfare or the natural environment?	_____	<u>X</u>	_____
44. Will the action be of statewide significance?	_____	<u>X</u>	_____
45. Are there any other plans or actions (federal, state, county or private) that, in conjunction with the subject action could result in a cumulative or synergistic impact on the public health, safety, welfare, or environment?	_____	<u>X</u>	_____
46. Will the action require additional power generation or transmission capacity?	_____	<u>X</u>	_____
47. This agency will develop a complete environmental effects report on the proposed action.	_____	_____	_____

SECTION I

A. PROJECT LOCATION

This portion of existing U.S. Route 29 extends from the Patuxent River bridge at the Howard County line to the U.S. Route 40 interchange (Figure 1). The roadway lies in a north-south direction and intersects the following state roadways in the project area: Maryland Route 216, Maryland Route 32, Maryland Route 175, Maryland Route 108, and Maryland Route 103. In addition to Columbia, numerous major residential, commercial, and industrial developments are located along the 4-lane and 6-lane divided highway.

B. PROJECT DESCRIPTION

The proposed Build Alternate improvements to the 11.69-mile portion (Figure 2) of U.S. Route 29 should provide additional, safer, and more efficient capacity. Alternate B improvements include roadway widening from four to six lanes, with no control of access and no change to existing at-grade intersections and other access points, other than those intersections currently under development which are listed below. Alternate C improvements include roadway widening with control of access by constructing grade separations and/or service roads. Existing median crossovers and traffic signals would be removed. Several roads that currently have access to U.S. Route 29 would be closed permanently. Other roads that intersect U.S. Route 29 would remain open, but would overpass or underpass the highway with no direct connections.

Improvements to most of the interchanges on U.S. Route 29 in Howard County have developed as individual projects and are now in various stages of design, as follows:

- Maryland Route 216 -- Final Design
- Maryland Route 32 -- Constructed
- Broken Land Parkway (including Owen Brown Road and Columbia's South Entrance) -- Preliminary Studies
- Maryland Route 175 -- Constructed
- Maryland Route 108 -- Currently Under Construction
- Maryland Route 103 -- Final Design

Analysis of potential environmental impacts of these separate interchange projects, which are not included in this document, are contained in the environmental document prepared for the individual projects. The areas excluded from this Environmental Assessment are shown on Figure 2.

Four separate Technical Analysis Reports were prepared in support of this document. The Socioeconomic, Natural Resources, Air Quality, and Noise Analysis Reports contain the detailed methodologies, data, and analysis of results of the respective discipline areas. These documents serve to support this Environmental Assessment.

The documents prepared for the excluded interchanges, and the Technical Analysis Reports prepared for this assessment, are available for review at the Federal Highway Administration and Maryland State Highway Administration offices noted in the summary.

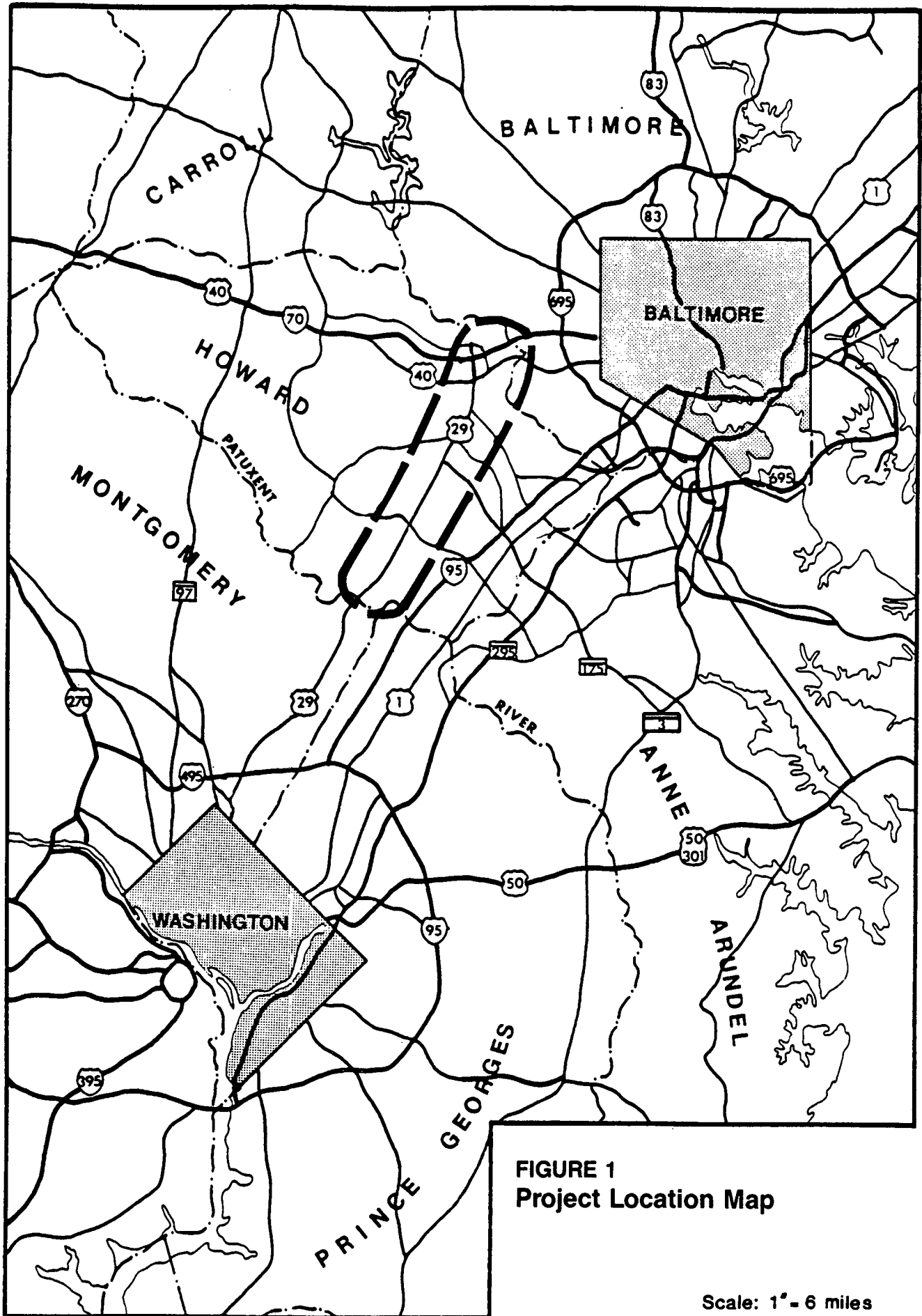

**FIGURE 1**  
**Project Location Map**

Scale: 1" = 6 miles

FIGURE 2  
Study Area

1 of 2

SCALE: 1" = 2000'

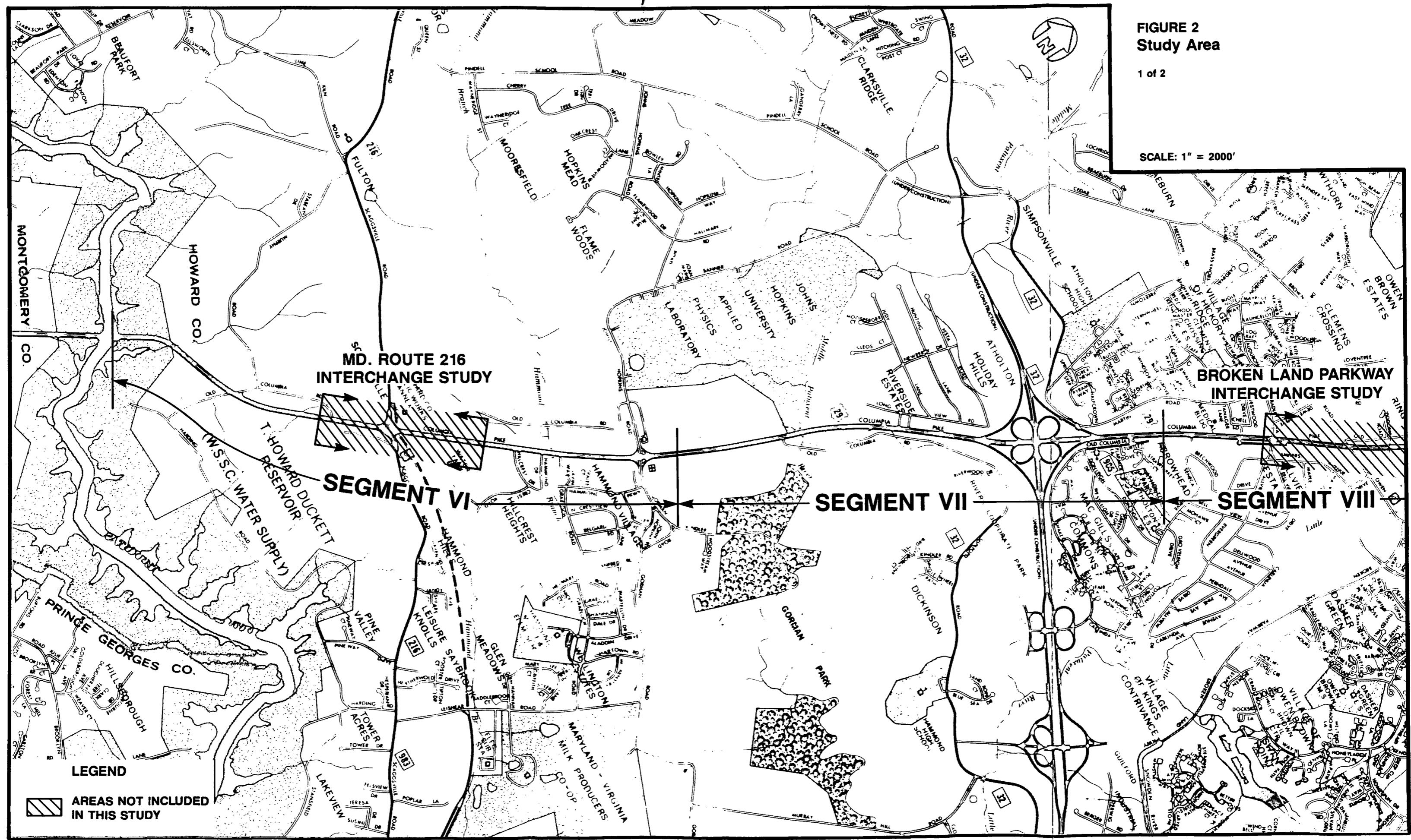



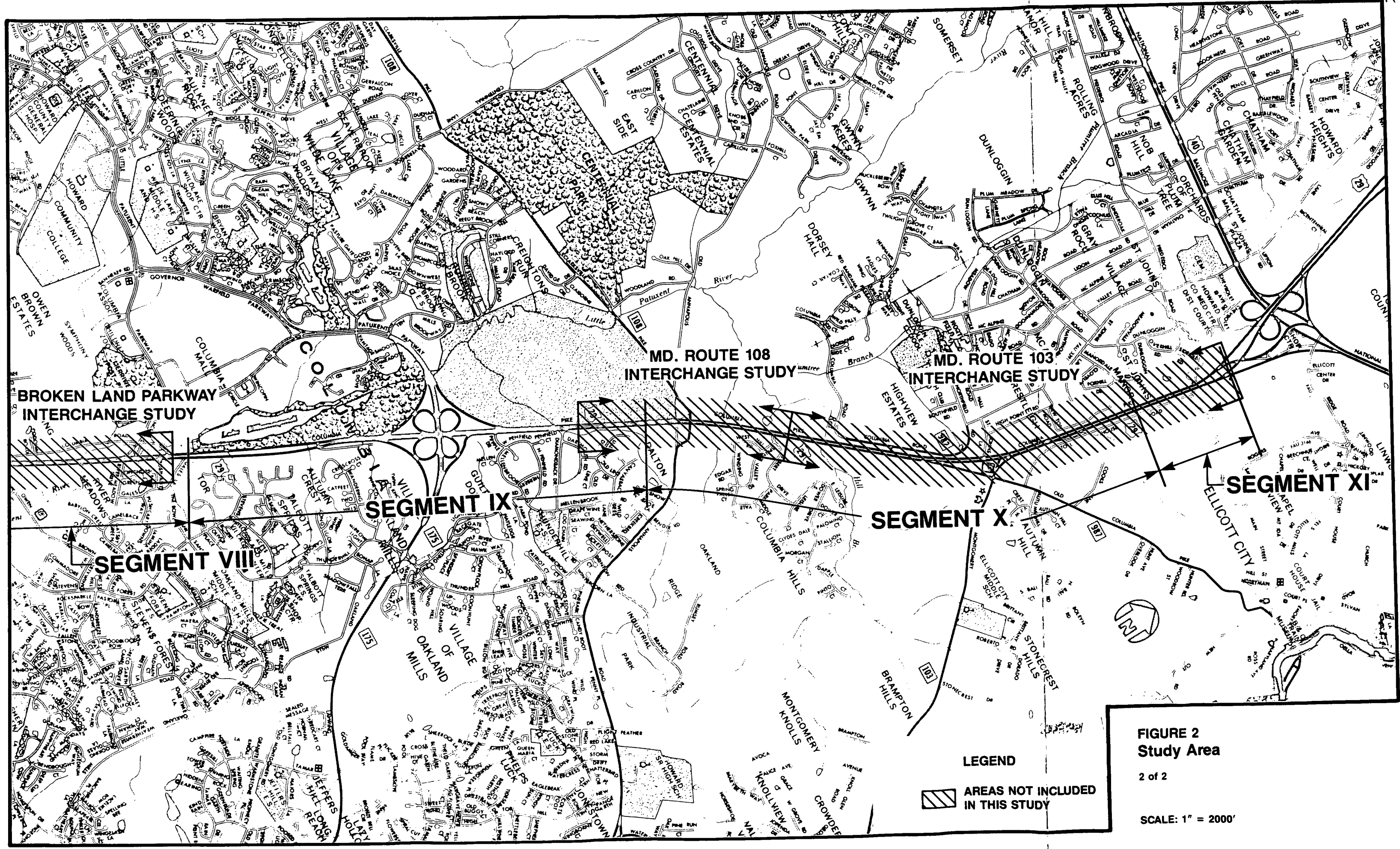

**BROKEN LAND PARKWAY  
INTERCHANGE STUDY**

**MD. ROUTE 108  
INTERCHANGE STUDY**

**MD. ROUTE 103  
INTERCHANGE STUDY**

**SEGMENT VIII**

**SEGMENT IX**

**SEGMENT X**

**SEGMENT XI**

**LEGEND**

 **AREAS NOT INCLUDED  
IN THIS STUDY**

**FIGURE 2  
Study Area**

2 of 2

SCALE: 1" = 2000'

C. DESCRIPTION OF EXISTING ENVIRONMENT

1. Land Use and Planning

U.S. Route 29 is one of three major highways (in addition to I-95 and Baltimore-Washington Parkway) in the highway corridor connecting the Baltimore and Washington areas. As such, many suburban "bedroom communities" have developed within the highway corridor. The growth of these residential communities over the past years has shaped the existing land use along U.S. Route 29. Because of its direct access to the two metropolitan areas, the highway corridor has attracted industries desiring improved access, but wishing to locate outside of the cities. The existing land use along the route is primarily residential, but commercial/industrial use is interspersed at major intersections (Figure 3). Residential, commercial/industrial, and institutional/public developments that would be directly impacted by changes in access control are identified in Table 1.

The "new town" of Columbia in Segments VII, VIII and X was developed in 1968 by James Rouse. It is segmented into eight villages. Five of these villages are complete; the remaining three are at various stages of development. Each village is a "self-contained" unit providing educational facilities, essential support services, and playground/recreational facilities at the village center. Each village contains approximately three neighborhoods of 600 to 800 dwelling units, offering a variety of housing types.

A major component of the 1982 Howard County General Plan is the land use plan.<sup>1</sup> The challenge to the County is to control a dynamically changing environment. Location factors, including a strategic location in the Washington/Baltimore Corridor and a shift of major transportation from Anne Arundel County to Howard County via I-95 and U.S. Route 29, have been primary contributors to the growth of the area. Meeting the challenge has meant preparing a list of objectives to guide future growth, including:

- . promote private economic growth
- . reserve industrial and employment center lands
- . prevent the intermixing of incompatible land uses
- . enhance general property values to support public services
- . establish efficient transportation systems
- . establish efficient community facilities
- . control growth sequence through timing extensions of communities and community services
- . provide planned commercial facilities

The land use plan divides all land into one of three areas: conservation, stable, and development. Each of these areas are divided further; however, clarification is provided here only for those areas within the project's six segments--Segment VI through Segment XI.

The conservation district generally lies beyond the public utility service area. The purpose of the area is to protect the natural environment and agri-economy of the rural areas from uncontrolled and/or premature growth.

Stable areas are those areas that are not expected to change. Five stable categories are found in the study area: residential, commercial, industrial, public, and "new town."

TABLE 1  
LAND USE DEVELOPMENT

<u>SEGMENT</u>	<u>RESIDENTIAL</u>	<u>COMMERCIAL/INDUSTRIAL</u>	<u>INSTITUTIONAL/PUBLIC</u>
VI	Hammond Hills Hillcrest Heights Hammond Village	Cherry Tree Shopping Center Montpelier Research Park Johns Hopkins University Applied Physics Lab.	T. Howard Duckett Reservoir Howard County Public Works Annex
VII	Riverside Estates Holiday Hills  Columbia: Village of King's Contrivance Dickinson MacGills Common Allview Estates Village of Hickory Ridge Clemens Crossing	Montpelier Research Park Johns Hopkins University Howard Research & Devel. Rivers Corporate Park	Church of God Campground
VIII	Columbia: Village of King's Contrivance Allview Estates Village of Hickory Ridge Clemens Crossing Sebring Village of Oakland Mills Stevens Forest Talbot Springs	Columbia Town Center	
IX	Columbia: Village of Oakland Mills Talbot Springs Guilford Downs Dalton	Columbia Town Center	Lake Kittamaquondi
X	Columbia: Village of Oakland Mills Dalton Columbia Hills Village of Dorsey Search  Highview Estates Crestleigh McAlpine St. John's Manor		Ellicott City Armory

FIGURE 3  
Existing Land Use Map

1 of 2

SCALE: 1" = 2000'

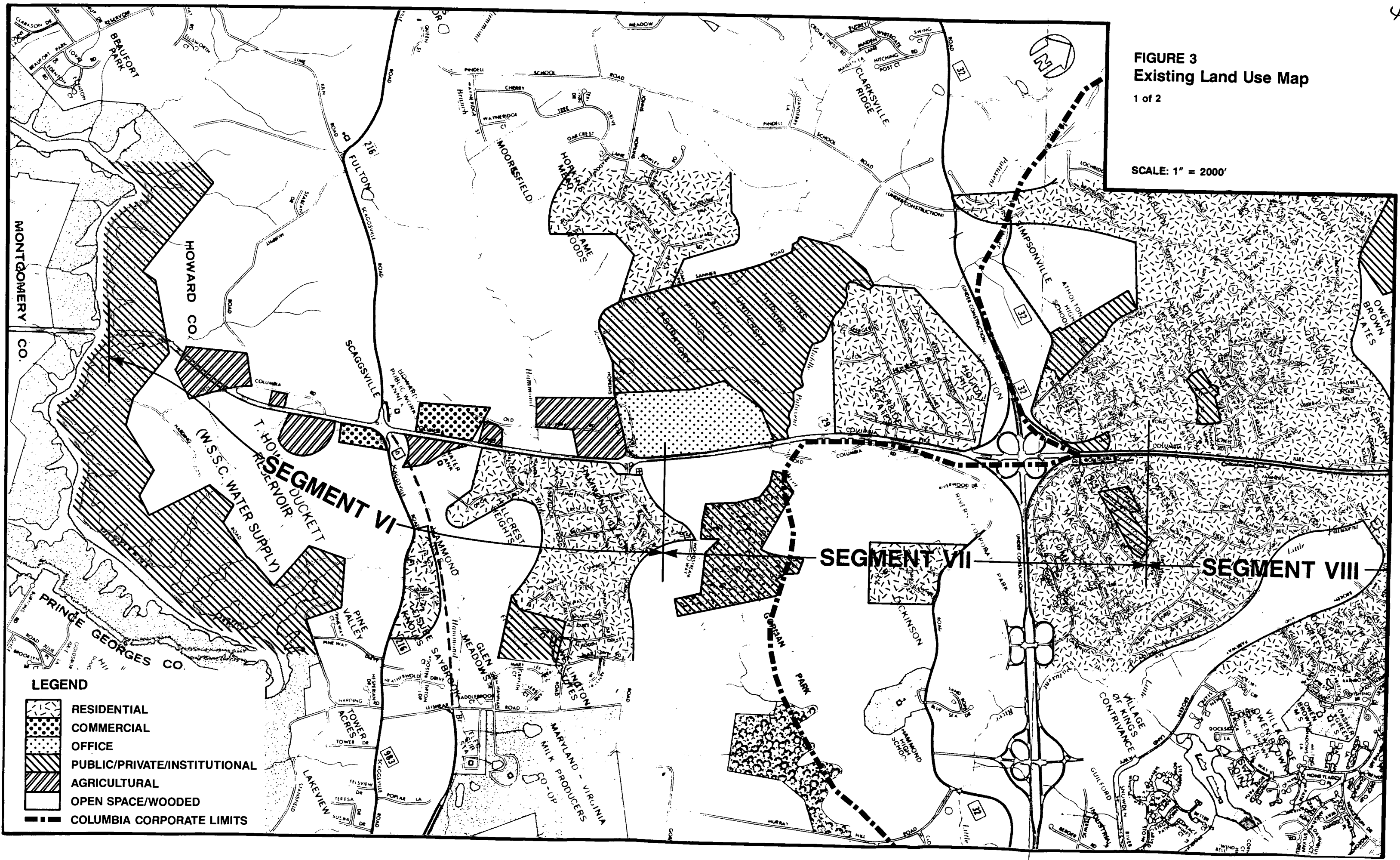

**LEGEND**

	RESIDENTIAL
	COMMERCIAL
	OFFICE
	PUBLIC/PRIVATE/INSTITUTIONAL
	AGRICULTURAL
	OPEN SPACE/WOODED
	COLUMBIA CORPORATE LIMITS

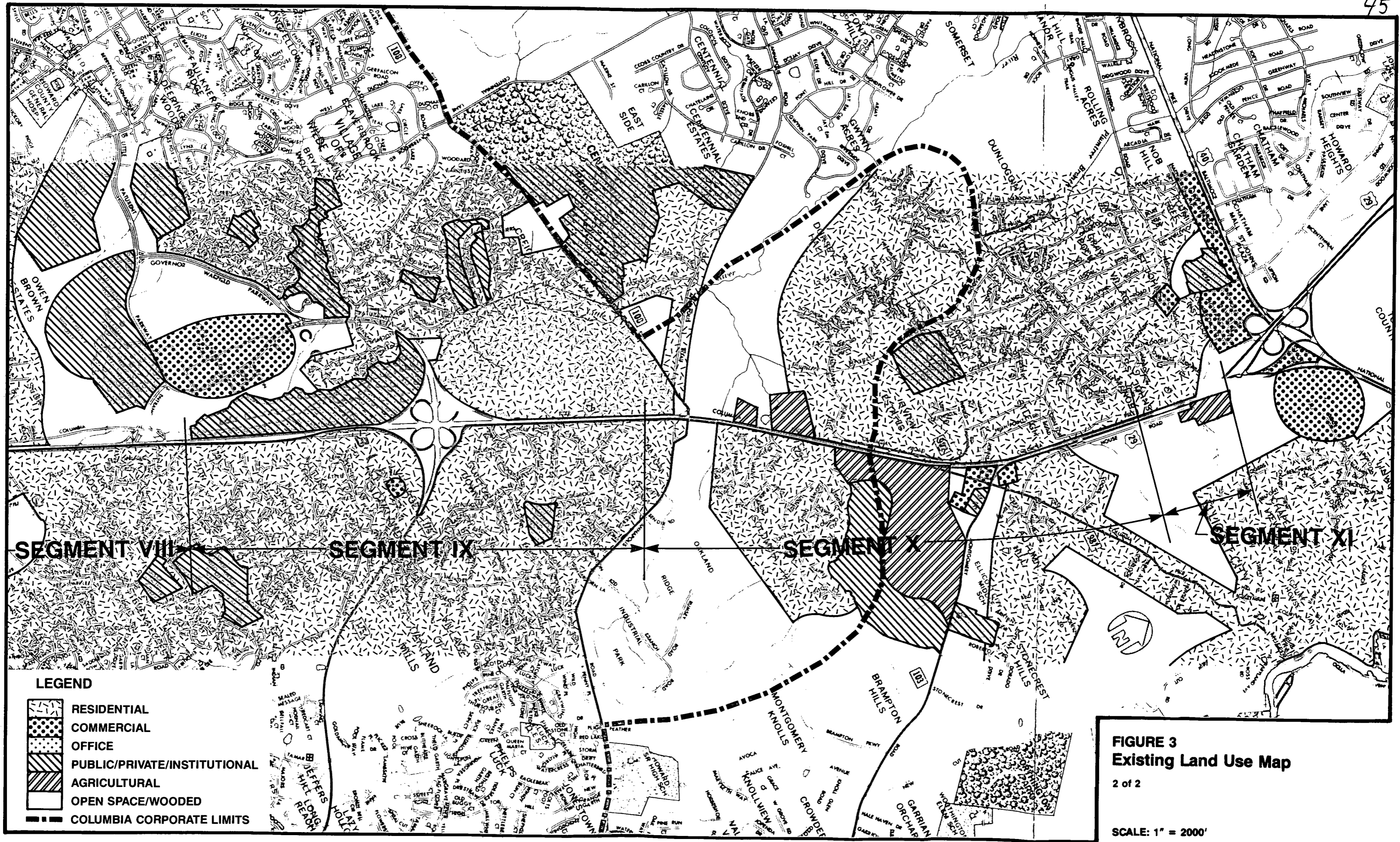







SEGMENT VII

SEGMENT IX

SEGMENT X

SEGMENT XI

**LEGEND**

-  RESIDENTIAL
-  COMMERCIAL
-  OFFICE
-  PUBLIC/PRIVATE/INSTITUTIONAL
-  AGRICULTURAL
-  OPEN SPACE/WOODED
-  COLUMBIA CORPORATE LIMITS

**FIGURE 3**  
**Existing Land Use Map**

2 of 2

SCALE: 1" = 2000'

The final division of land is the development district. From a planning perspective, delineation of land use within this area will have the greatest impact on future growth. Five of the eight categories are included in the study area: planned employment center; basic employment center; and low-, medium, and high-density residential centers.

Figure 4 shows the areas adjacent to U.S. Route 29 that are designated for land use change. The only area in Segment VI designated for change is located within an existing agricultural area east of U.S. Route 29 and south of Maryland Route 216. This area lies in the conservation reserve area of the county. The western corridor is not expected to develop rapidly. This area--from the Howard County Line to Montpelier Research Park at John Hopkins Road--is designated rural conservation. Future development is not encouraged in the area.

Segment VII has one existing residential development area adjacent to Maryland Route 32 that is designated for expansion. The corridor in Segments VIII and IX is developed to its fullest potential. The areas having the greatest development potential are located in Segments X and XI at the U.S. Route 29 intersection with Maryland Routes 108 and 103. The area adjacent to Maryland Route 108 is slated for high- and medium-density residential use. North of this area is a planned basic employment center. Similarly, south of Maryland Route 103 are a planned medium-density residential area and a basic employment center. However, the basic employment is incompatible with the nearby residential development. A more compatible configuration exists adjacent to Route 987, where a basic employment area is adjacent to the Ellicott City environmental development. The environmental development area pertains to land surrounding Ellicott City, which is a unique area for its historical significance.

## 2. Population and Housing Characteristics

A comparative analysis of State, County, and corridor population characteristics, illustrates the expected growth of the area. Data has been obtained from the Urban Transportation Planning Package (UTPP) by transportation zones<sup>2</sup> and from the 1983 County and City Data Book<sup>3</sup>. Criteria for the zonal data collection was to include all zones that have land within 1-1/2 miles of U.S. Route 29.

The boundaries of the study area are shown in Figure 5. Thirteen zones are included: zones 475-479, 481, 482, 484-486, 495, 507, and 509. Tables 2 and 3 describe the 1980 population and housing characteristics, respectively.

Compared to the State and County, the U.S. Route 29 Corridor has a lower percent of elderly population, but a six to eight percent higher child and adolescent population, putting added pressure on the educational system. The mean age of the population of this corridor is similar to the State and County as a whole. The corridor has a broader racial distribution than the County, but is racially less diverse than the State. There are no observable concentrations of elderly, handicapped, and minority persons in the project area. Table 3, 1980 Household Characteristics, describes the wealth of the area. The median income for households in the corridor is \$10,000 higher than the State median of \$20,281, and approximately \$2,000 higher than the County median of \$27,612.

Table 4 provides population projections for the years 1990 and 2005. The population is expected to experience continued growth throughout the period,

47

TABLE 2  
1980 POPULATION CHARACTERISTICS  
MARYLAND - HOWARD COUNTY - U.S. ROUTE 29 CORRIDOR

	<u>MARYLAND</u>	<u>HOWARD COUNTY<sup>a</sup></u>	<u>U.S. ROUTE 29 CORRIDOR<sup>b</sup></u>
Number of Persons	4,216,975	118,572	66,858
Persons over 64 Years	N/A	N/A	2,640
Percent of Total Population	9.4%	5.1%	4.0%
Persons under 19 Years	N/A	N/A	23,420
Percent of Total Population	27.7%	30.7%	35.0%
Mean Age (Years)	30.3	30.1	30.5
Race Composition			
White Population	N/A	N/A	55,422
Percent of Total Population	75%	86%	82%
Black Population	N/A	N/A	9,931
Percent of Total Population	23%	12%	14%
American Indian, Eskimo and Aleut. Population	N/A	N/A	158
Percent of Total Population	.22%	.14%	.20%
Noninstitutional Persons 16 to 64 Years with Public Transportation Disability	49,233	816	N/A
Percent of Total Population	1%	.69%	N/A

a Source: 1983 County and City Data Book

b Source: "1980 Census of the Population" from the Urban Transportation Planning Package by Transportation Zones

FIGURE 4  
Areas Designated for Land Use Change

1 of 2

SCALE: 1" = 2000'

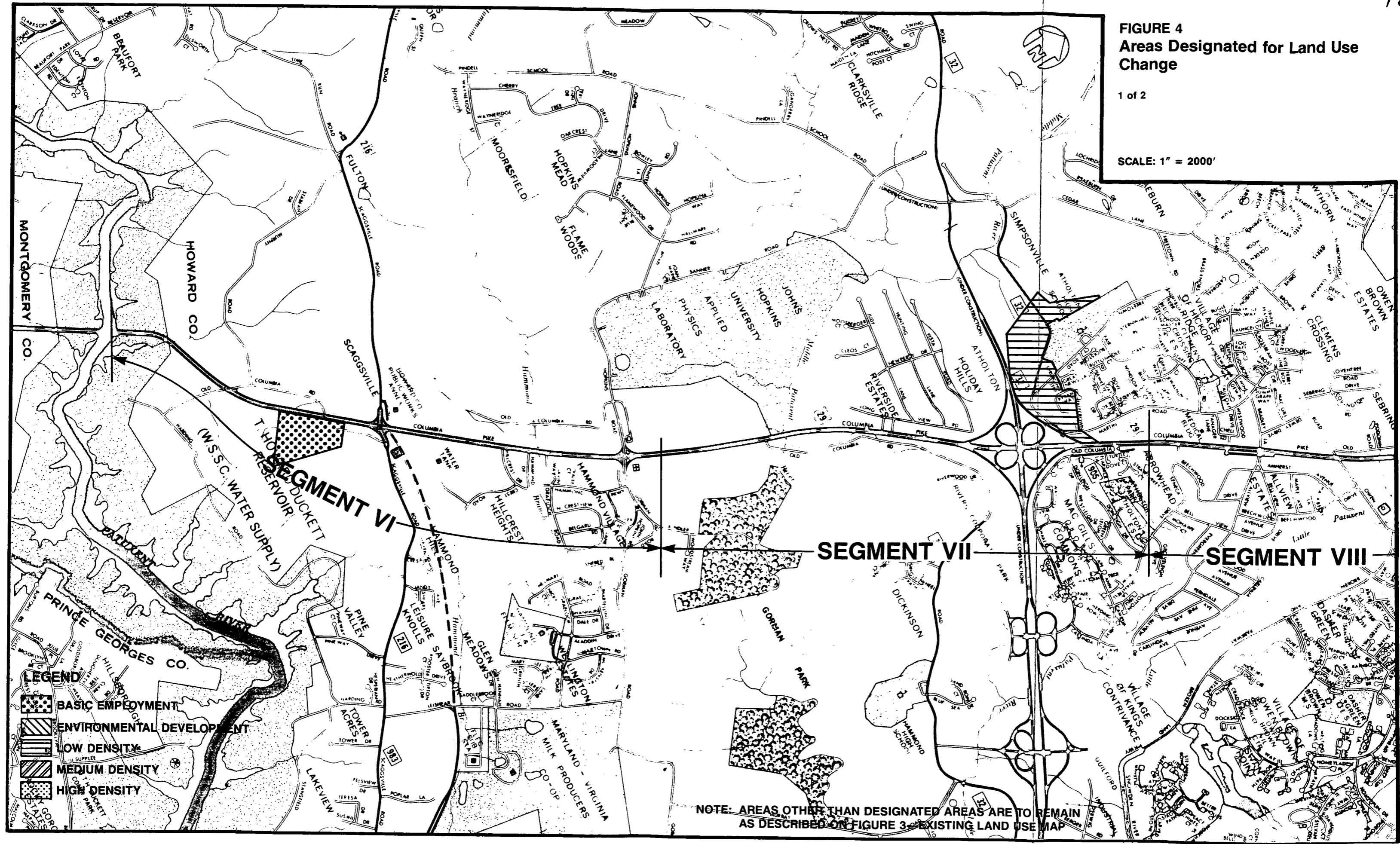



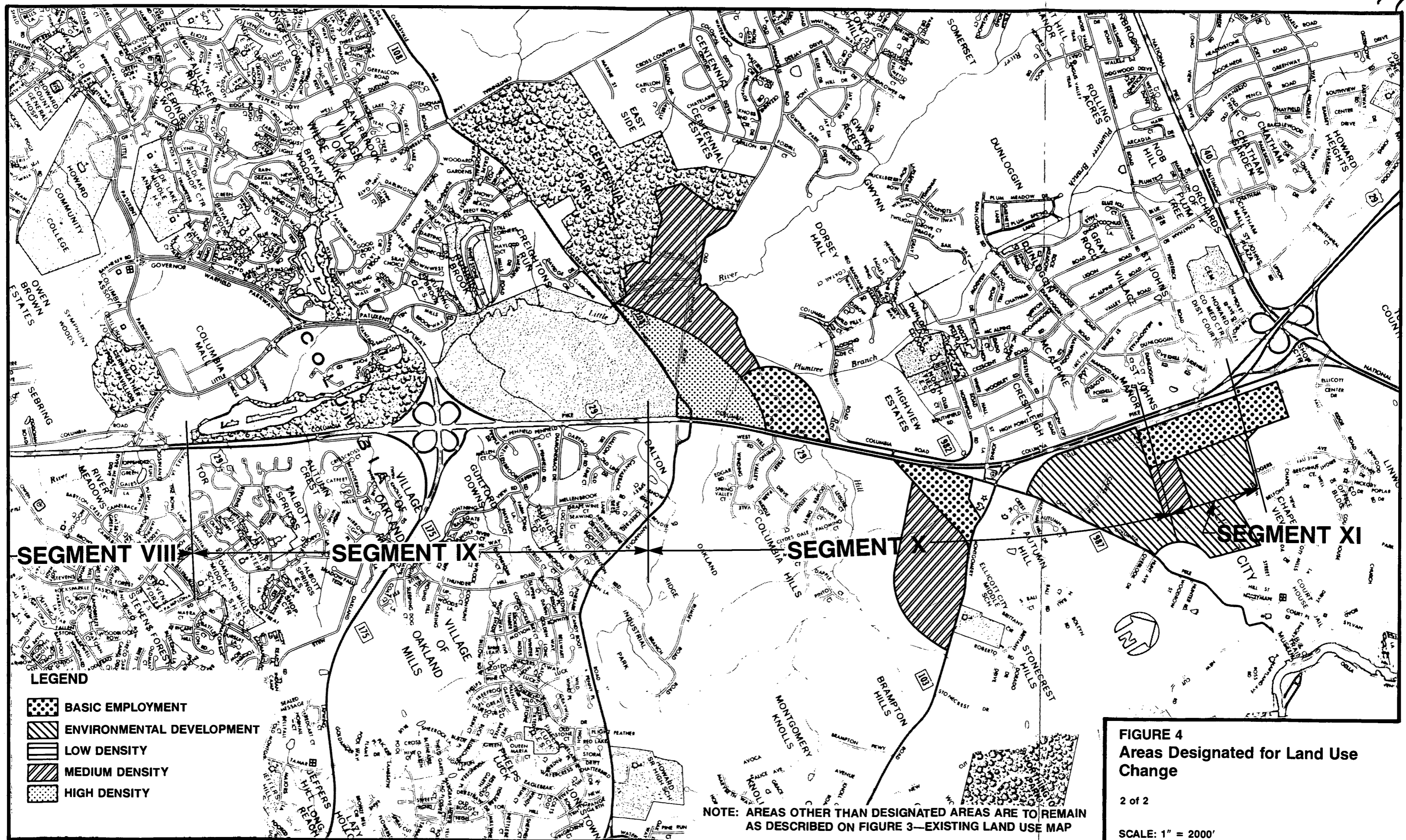

NOTE: AREAS OTHER THAN DESIGNATED AREAS ARE TO REMAIN AS DESCRIBED ON FIGURE 3, EXISTING LAND USE MAP





**SEGMENT VIII**      **SEGMENT IX**      **SEGMENT X**      **SEGMENT XI**

- LEGEND**
-  BASIC EMPLOYMENT
  -  ENVIRONMENTAL DEVELOPMENT
  -  LOW DENSITY
  -  MEDIUM DENSITY
  -  HIGH DENSITY

**FIGURE 4**  
**Areas Designated for Land Use Change**  
 2 of 2  
 SCALE: 1" = 2000'

NOTE: AREAS OTHER THAN DESIGNATED AREAS ARE TO REMAIN AS DESCRIBED ON FIGURE 3—EXISTING LAND USE MAP

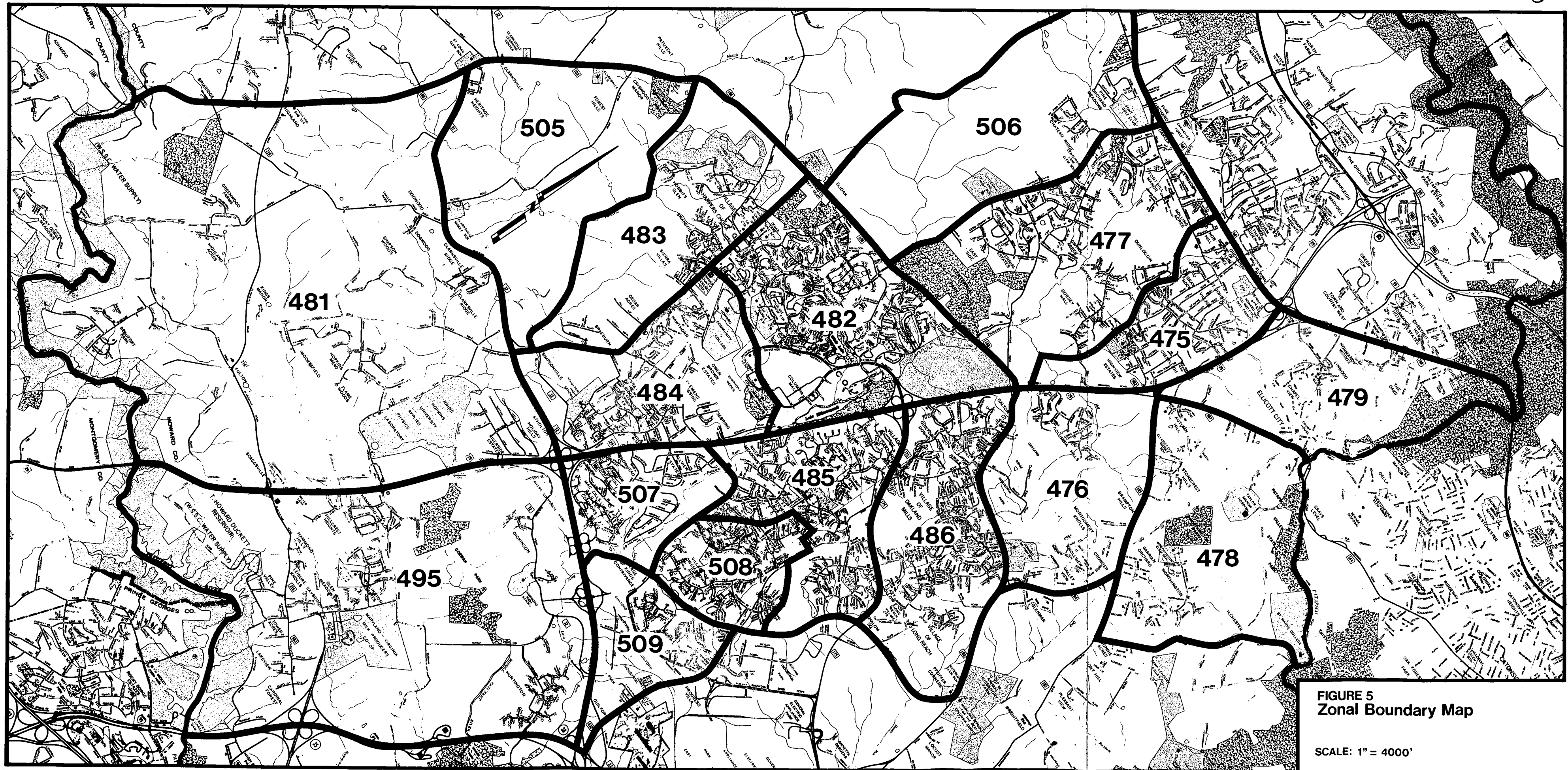

**FIGURE 5**  
**Zonal Boundary Map**

SCALE: 1" = 4000'

TABLE 3  
1980 HOUSEHOLD CHARACTERISTICS

	<u>1980 NUMBER OF HOUSEHOLDS</u>	<u>AVERAGE HOUSEHOLD SIZE</u>	<u>HOUSEHOLD MEDIUM INCOME</u>	<u>NUMBER OF HOUSING UNITS</u>	<u>PERCENT HOUSEHOLDS WITH NO VEHICLES</u>
Maryland <sup>a</sup>	4,216,975	2.82	20,281	1,570,907	NA
Howard County <sup>a</sup>	39,989	2.94	27,612	42,499	NA
U.S. Route 29 Corridor <sup>b</sup>	24,699	2.17	30,058	24,104	3%

<sup>a</sup> Source: 1983 County and City Data Book

<sup>b</sup> Source: "1980 Census of the Population" from the Urban Transportation Planning Package by Transportation Zones

TABLE 4  
ZONAL POPULATION CHARACTERISTICS AND PROJECTIONS

YEAR	<u>POPULATION</u>		<u>HOUSEHOLDS</u>		<u>AVERAGE HOUSEHOLD SIZE</u>	<u>LABOR FORCE</u>	
	<u>NUMBER OF PERSONS</u>	<u>PERCENT CHANGE</u>	<u>NUMBER OF HOUSEHOLDS</u>	<u>PERCENT CHANGE</u>		<u>NUMBER</u>	<u>PERCENT CHANGE</u>
1980	66,858		24,699		2.7	33,350	
1990	90,690	36%	33,840	37%	2.7	50,410	51%
2005	114,880	27%	46,170	36%	2.5	64,040	27%

Source: Baltimore Regional Planning Council, Cooperative Forecast/Round II, Socioeconomic Data 1980, 1990, 2005

at a rate of approximately 36 percent from 1980 to 1990 and another 27 percent from 1990 to 2005.

The number of households is expected to grow 37 percent from 1980 to 1990 and 36 percent from 1990 to 2005. An increase of 51 percent in the labor force is predicted between 1980 and 1990. An additional increase of 27 percent is projected from 1990 to 2005.

### 3. Neighborhood Characteristics

The Howard County General Plan clearly defines a distinctive planning framework whose goal is "to create a series of physically and socially unified neighborhoods that can blend to form an orderly environment for Howard County<sup>1</sup>."

Existing neighborhoods are shown in Figure 6, U.S. Route 29 Neighborhood Map. There are 19 neighborhoods in the U.S. Route 29 Corridor.

Neighborhoods outside of the Columbia corporate limits include, in Segment VI, Hammond Hills, Hillcrest Heights, and Hammond Village; in Segment VII, Riverside Estates and Holiday Hills; and in Segment X, Highview Estates, Crestleigh, McAlpine, and St. John's Manor. Neighborhoods within Columbia include: in Segment VII, Dickinson, MacGills Commons, and portions of Clemens Crossing and Allview Estates; in Segment VIII, Sebring and portions of Clemens Crossing, Allview Estates, Stevens Forest and Talbott Springs; in Segment IX, Guilford Downs and portions of Stevens Forest and Talbott Springs; and in Segment X, Columbia Hills.

### 4. Community Facilities and Services

The U.S. Route 29 Corridor is effectively serviced by community facilities. The County is the responsible local authority in the State of Maryland. Consequently, structures for the emergency, educational, and some recreational and health services are organized at the County level. Community facilities are shown in Figure 7.

#### a. Transportation System

The primary mode of transportation in the County is the automobile. For this reason, considerable time and money are spent on study updates, repairs, and improvements, of the highway systems. U.S. Route 29 is one of three highways in the highway corridor connecting the Baltimore and Washington areas. As the main connector between Washington and Baltimore, serving Ellicott City and Columbia, the existing and future capacity of U.S. Route 29 is critical to the vitality of adjacent communities. If forecasted population growth occurs, considerable traffic will be added to current conditions. In 1983, the Howard County Office of Planning and Zoning developed transportation goals, based on data collected from the Urban Transportation Planning Package, that identified potential future problem areas on U.S. Route 29. The following recommendations were made:

- . U.S. Route 29 should be upgraded to a principal arterial with four or more travel lanes with a median and right-of-way equaling 200 to 300 feet.
- . The primary function of the highway is service, not access.

FIGURE 6  
Neighborhoods Map

1 of 2

SCALE: 1" = 2000'

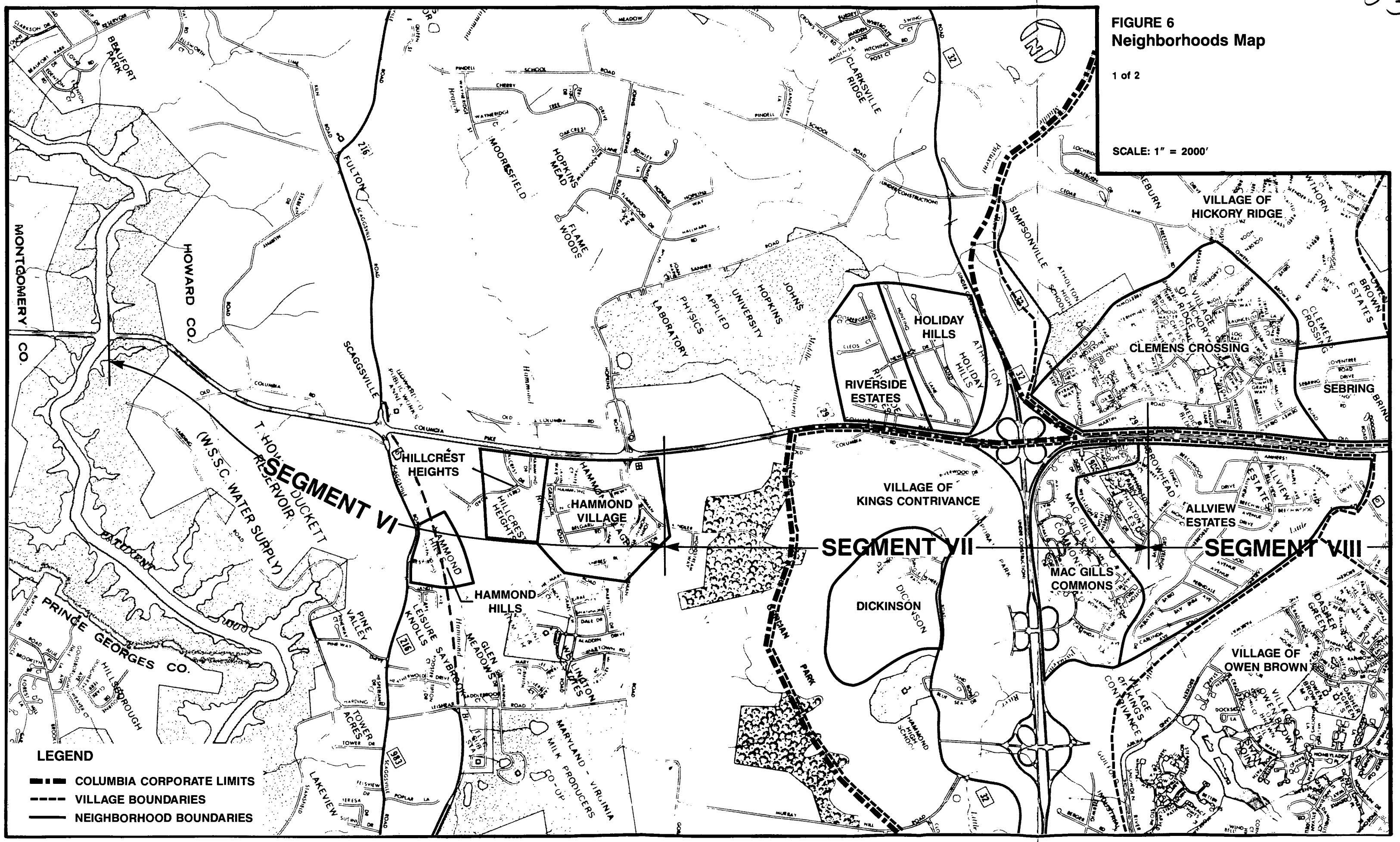

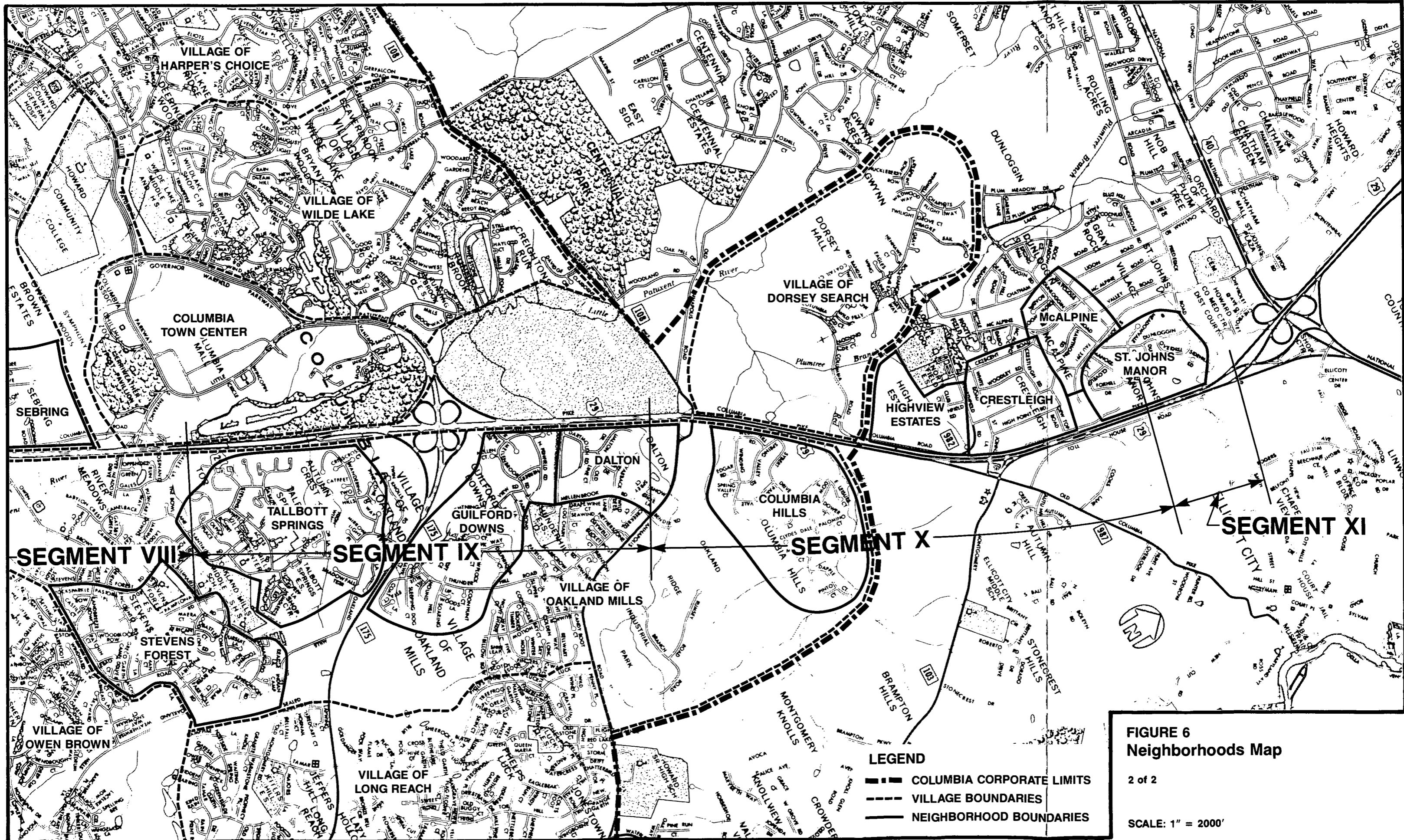

**FIGURE 6**  
**Neighborhoods Map**  
 2 of 2  
 SCALE: 1" = 2000'

- LEGEND**
- COLUMBIA CORPORATE LIMITS
  - - - VILLAGE BOUNDARIES
  - NEIGHBORHOOD BOUNDARIES

**FIGURE 7**  
**Community Facilities and**  
**Services Map**

1 of 2

Legend on Page following this Figure

SCALE: 1" = 2000'

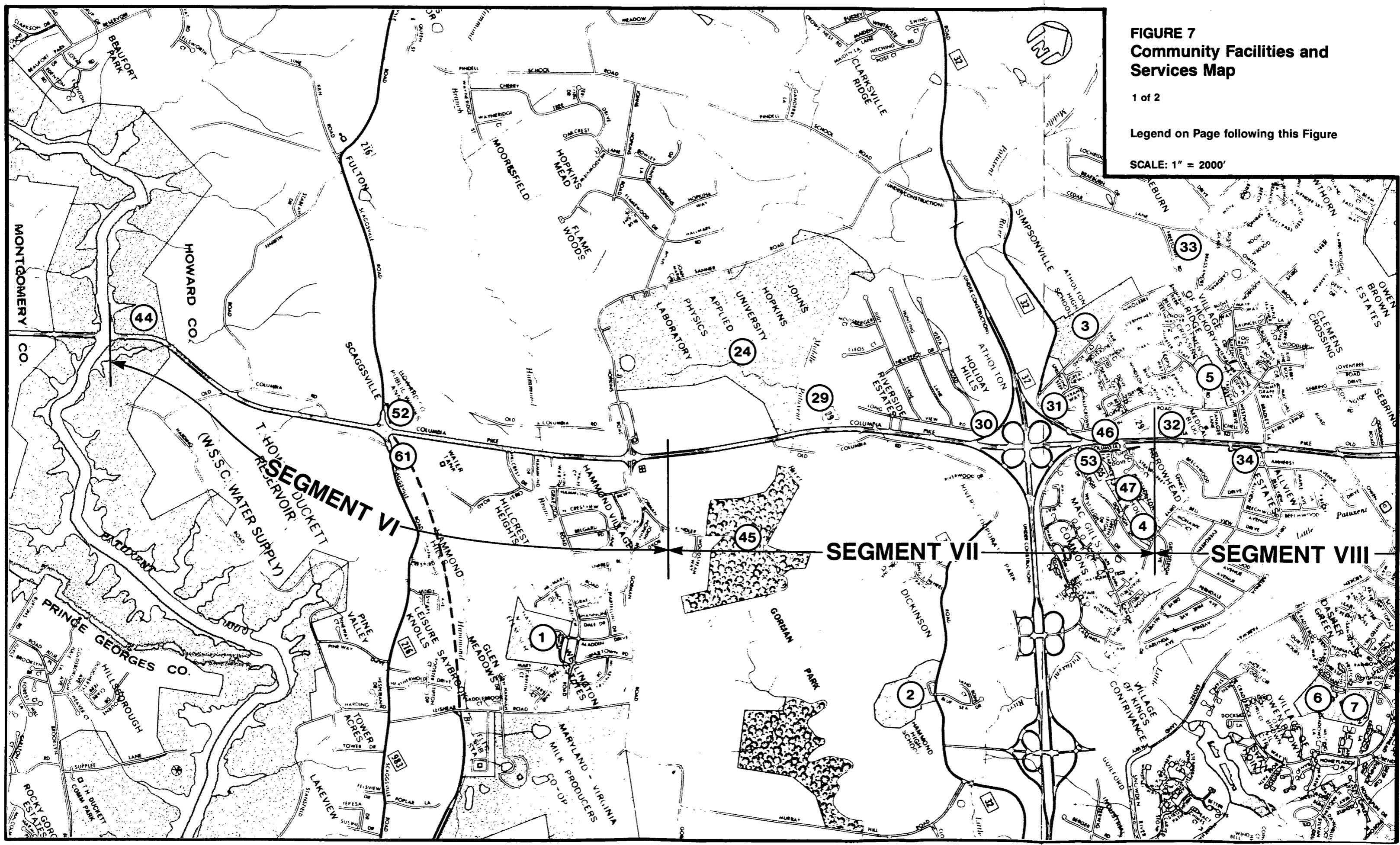

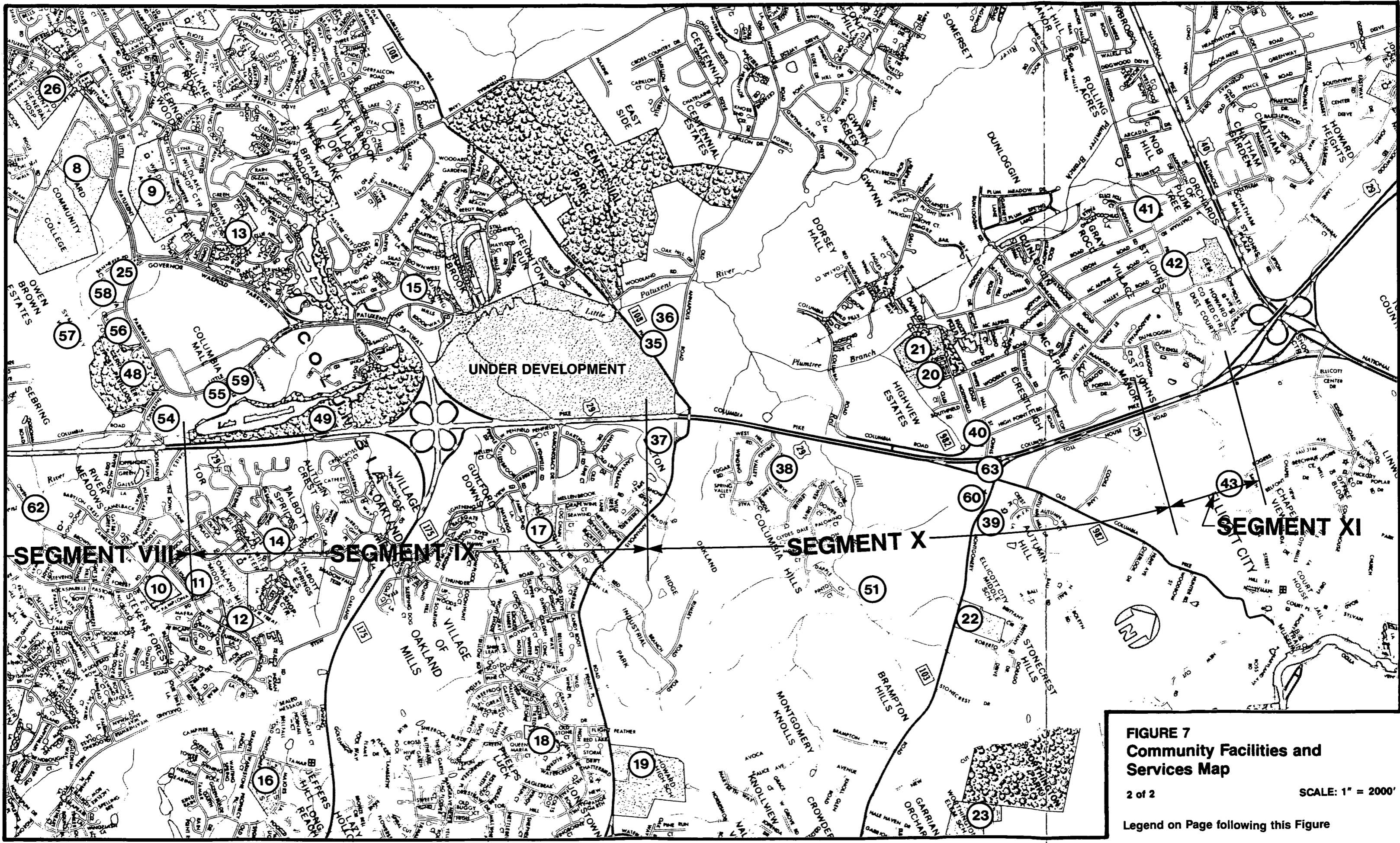

**FIGURE 7**  
**Community Facilities and Services Map**  
 2 of 2  
 SCALE: 1" = 2000'  
 Legend on Page following this Figure



LEGEND  
COMMUNITY FACILITIES AND SERVICES MAP

EDUCATIONAL SERVICES

1. Hammond Elementary and Middle
2. Hammond High
3. Atholton High
4. Atholton Elementary
5. Clemens Crossing Elementary
6. Owen Brown Middle
7. Dasher Green Elementary
8. Howard Community College
9. Wilde Lake Middle and High
10. Stevens Forest Elementary
11. Oakland Mills Middle
12. Oakland Mills Senior High
13. Bryant Woods Elementary
14. Talbott Springs Elementary
15. Running Brook Elementary
16. Jeffers Hills Elementary
17. Thunder Hill Elementary
18. Phelps Luck Elementary
19. Howard Senior High
20. Northfield Elementary
21. Dunloggin Middle
22. Ellicott City Middle
23. Worthington Elementary

EMERGENCY SERVICES

24. Johns Hopkins Applied Physics  
Laboratory -- Private Fire  
Department
25. Columbia Company 7

HEALTH CARE FACILITIES

26. Howard County General Hospital

RELIGIOUS FACILITIES

29. Church of God Camp Grounds
30. Holiday Hills Baptist (no longer exists)
31. Locust United Methodist
32. Atholton Seventh Day Adventist
34. Christ Memorial Presbyterian
35. Maple Grove Mennonite
36. Harvester Baptist
37. First Presbyterian of Howard County
38. Epiphany Lutheran
39. Bethel Baptist
40. Church of Jesus Christ of Latter Day Saints
41. First Lutheran
42. St. Johns's Episcopal
43. Mt. Zion United Methodist

PARKS

44. Washington Suburban Sanitary  
Commission Park
45. Kindler Area Park
46. Martin Road Park
47. Atholton Park
48. Merriweather Post Pavilion
49. Lake Kittamaquundi
51. Brampton Hills Park

MISCELLANEOUS FACILITIES

52. Howard County Public  
Water Works
53. Simpsonville Post Office
54. Howard County Library
55. American Cities Post Office
56. Children's Zoo
57. Symphony Woods
58. Columbia Association
59. Columbia Exhibition and  
Information Building
60. Ellicott City Armory

PARK AND RIDES

61. Maryland Route 216
62. Broken Land Parkway
63. Maryland Route 103

- . Intersecting road traffic should be controlled by interchanges.
- . The following intersections should be replaced with grade-separated interchanges:
  - Maryland Route 216
  - Hopkins/Gorman Road
  - Maryland Route 32
  - Broken Land Parkway
  - Little Patuxent Parkway/Maryland Route 175
  - Maryland Route 108 and
  - Maryland Route 103

Two types of public transportation would be sensitive to improvements made to U.S. Route 29: fixed route transit service and commuter bus service.

The fixed route transit service refers to the local ColumBus and Eyre's/Trailways System. ColumBus would not be significantly impacted by the U.S. Route 29 project. The Eyre's/Trailways System is limited to areas along U.S. Route 40 and U.S. Route 29.

Commuter bus service operates to transport residents of the Baltimore/Washington Corridor into the city employment centers. Two firms, Carter's and Eyre's Bus Service, offer commuter service. These services are accessible to the residents within the U.S. Route 29 Corridor, and are the primary available source of public transportation. Access points to the bus service are located on U.S. Route 29, primarily at major intersections and at park-and-ride lots. Access points would be sensitive to any improvements made to the highway.

Numerous ride-sharing programs, through carpooling, vanpooling, and park-and-ride lots originated in Howard County as a result of the gasoline shortages of the 1970s. Five park-and-ride lots, which offer direct bus service, are available to County commuters. Three park-and-ride lots exist on U.S. Route 29 at intersections with: Maryland Route 103, Maryland Route 216, and the Broken Land Parkway. Additionally, park-and-ride lots are proposed on U.S. Route 29 at intersections with Maryland Routes 108 and 32.

The bicycle is another mode of transportation popular in the Howard County area. According to the Maryland Association of Bicycle Organization, the Baltimore-Washington Corridor contains no other major roads that permit safe, efficient bicycle transportation. Bicycle transportation is limited to U.S. Route 29 because of numerous river crossings and lack of parallel roads serving the corridor.

b. Emergency Services

Stations that provide both fire and emergency services for the U.S. Route 29 Corridor include:

- . Columbia Company 7 -- west of Columbia on Banneker Road and Little Patuxent Parkway

- . Ellicott City Company 2 -- Main Street, Ellicott City
- . Long Reach Co. 9 -- Village of Long Reach, Maryland Route 175
- . Johns Hopkins Applied Physics Laboratory -- private fire department

As growth occurs, new fire companies are proposed for the intersections of U.S. Route 29 with Maryland Route 32 and Maryland Route 108.

Police protection is provided by the Howard County Police Department, located in Ellicott City, and the Maryland State Police.

Another emergency facility that exists in the corridor is an emergency boat ramp maintained by the Washington Suburban Sanitary Commission (WSSC) at Harding Road. This ramp serves the WSSC impoundment.

c. Health Care Facilities

Howard County's location within the Baltimore/Washington Corridor enhances resident accessibility to a wide variety of prestigious health facilities. The only facility within the impact area of the proposed highway project is Howard County General Hospital, located adjacent to Howard Community College on Maryland Route 175.

d. Educational Facilities

Public education is organized at the County level. The U.S. Route 29 Corridor contains 16 elementary schools, 7 public middle schools, 5 public high schools, 2 public special schools, and 1 private school. Improvements made to the Route would affect these schools. Schools most affected would be those with buses currently accessing U.S. Route 29 through left-turn movements at at-grade intersections, those with attendance areas on both sides of U.S. Route 29, and those with students residing immediately adjacent to U.S. Route 29.

Schools within the study area having bus routes that use a left-turn movement from U.S. Route 29 through at-grade intersections include:

<u>School</u>	<u>Location</u>
Hammond Elementary	Hopkins-Gorman Road
Hammond Middle	Hopkins-Gorman Road
Atholton High	Hopkins-Gorman Road
Hammond High	Hopkins-Gorman Road
Atholton Elementary	Seneca Drive
Clemens Crossing Elementary	Owen Brown Road
Clarksville Middle	Seneca Drive & Owen Brown Road
Oakland Mills High	Seneca Drive
Oakland Mills Middle	Seneca Drive
Northfield Elementary	Spring Valley Road
Dunloggin Middle	Spring Valley Road
Centennial High	Spring Valley Road

Schools having attendance areas on both sides of U.S. Route 29, necessitating the crossing of the route by school buses, include:

60

Centennial High  
Mt. Hebron High  
Atholton High  
Patapsco Middle  
Dunloggin Middle  
Wilde Lake Middle  
Clarksville Middle  
St. John's Lane Elementary  
Northfield Elementary  
Thunder Hill Elementary

These attendance areas are reviewed and changed annually. Schools having pupils who reside immediately adjacent to U.S. Route 29 include:

Talbott Springs Elementary  
Atholton Elementary  
Hammond Elementary  
Dunloggin Middle  
Clarksville Middle  
Hammond Middle  
Centennial High  
Oakland Mills High  
Hammond High

The location of these schools is shown in Figure 7.

In addition to public and private secondary education, Howard County houses five higher-education institutions:

- . Howard Community College -- Little Patuxent Parkway
- . Howard Vocational and Technical Center -- Clarksville Pike, Maryland Route 108
- . Johns Hopkins Applied Physics Laboratory -- Johns Hopkins Road, Riverside
- . University of Maryland Horse Research Center -- Route 108, near Pfeiffer Corner
- . University of Maryland Central Farm -- Folly Quarter Road and Homewood Road
- e. Religious Facilities

Thirteen places of worship are included within the U.S. Route 29 Corridor.

f. Recreation Parks

There are seven parks in the U.S. Route 29 study area: the Washington Suburban Sanitary Commission Park; the Kindler Area, Martin Road Park; Atholton Park; Merriweather Post Pavilion; Lake Kittamaquindi; and Brampton Hills Park. No parkland would be taken by the U.S. Route 29 project, therefore, there would be no Section 4(f) involvement.

61

Ownership and operation of the parks are the responsibility of the following agencies and groups. Washington Suburban Sanitary Commission (WSSC) Park is owned by WSSC. Both Merriweather Post Pavilion and Lake Kittamaquidi are owned and operated by the Columbia Association, a private, nonprofit company. The Allview Golf Course is a privately owned facility now being developed for residential use. The remainder of the parks are owned and operated by the Howard County Department of Recreation and Parks.

The corridor parks offer a wide range of recreational activities to the community. Water activities, equestrian trails, tot lots, game courts and fields, and exercise stations are a few of the recreational activities offered to the community.

g. Miscellaneous Facilities

Figure 7 shows the location of miscellaneous facilities located throughout the corridor. Many of these facilities are located in Columbia's "Town Center" between Columbia's south entrance and Little Patuxent Parkway. Facilities in the "Town Center" are the Howard County Library, American Cities Post Office, Children's Zoo, Symphony Woods, Columbia Association, and Columbia Exhibition and Information Building. Within Segment VI is Howard County Public Water Works. In Segment VII, north of Maryland Route 32, is the Simpsonville Post Office. The only other facility is the Ellicott City Armory, which is south of Maryland Route 103.

5. Historic and Archeological Resources

An historic sites survey of the study area was conducted in consultation with the Maryland Historical Trust (letter in Section V). It resulted in the identification of 7 Howard County sites which are possibly eligible for the National Register of Historic Places. The site locations are shown on the maps in Section III. These sites are:

Scaggs Place (HO 269)

This rambling dwelling is significant for its traditional architectural form developed by accretion during the nineteenth century. The original log structure was expanded to accommodate the growing Scaggs family. It is also important as a reminder of the early settlement patterns and history of this once agrarian area. (See Detailed Alternates Mapping, Sheet 2 of 8, in Section III)

Athol (HO 37)

Athol is the original rectory of the Old Brick Church, or Christ Church, of Guilford. Built of stone in the early eighteenth century, it is significant as one of the earliest dwellings which is still extant in Howard County. (See Detailed Alternates Mapping, Sheet 4 of 8, in Section III)

Kelly's Store House (HO 154)

Reputedly the Cooper's house of the nineteenth century Oakland Mills industrial complex, this early nineteenth century stone house is significant for its association with the early industry of Howard County. (See Detailed Alternates Mapping, Sheet 6 of 8, in Section III)

62

Gales-Gaither House (HO 155)

The Gales-Gaither House is significant as a remnant of the nineteenth century workers' housing which was constructed for employees of Oakland Mills. (See Detailed Alternates Mapping, Sheet 6 of 8, in Section III)

Felicity (HO 430)

Felicity is significant for its association with Oakland Mills and thus the early industrial history of Howard County. The stone dwelling housed the company blacksmith who worked in the shop, which is still extant. (See Detailed Alternates Mapping, Sheet 7 of 8, in Section III)

Dorsey Hall (HO 28)

Dorsey Hall is significant as an early nineteenth century mansion which was built by the prominent Dorsey family. The family owned the mansion throughout the nineteenth century. (See Detailed Alternates Mapping, Sheet 7 of 8, in Section III)

Long Reach (HO 87)

Long Reach is significant for its architectural form, having evolved to its present state throughout the nineteenth century. It is also significant for its association with the Dorsey and Pue families who figured prominently in the early history of Howard County. (See Detailed Alternates Mapping, Sheet 7 of 8, in Section III)

No archeological sites were identified in the Phase I archeological survey.

6. Economic Characteristics

a. Economic Activity

Important to the vitality of any economy is the economic community's commitment to enhancing its basic industries that are the prime exporters of goods and services. A healthy basic economy, in turn, is concomitant to the health of the nonbasic economy, i.e., producers of goods and services used locally. Adequate transportation systems are critical to the sustenance of the basic economy. Industries located along U.S. Route 29 would be extremely sensitive to proposed changes along the route. Accessibility to and from the highway is the primary consideration. Figure 3 shows the location of commercial and office complexes in the area.

Based on UTPP zonal data, total commercial and industrial land use of the corridor was 1,044 acres in 1980. Figure 5 shows the zonal boundaries. The majority of land is used by the stable commercial and office areas shown in Figure 3, and by the Johns Hopkins Applied Physics Laboratory. Commercial and industrial land use is predicted to grow to 2,025 acres by the year 1995 and to 2,938 acres by 2005. Future basic industrial growth would be separated physically along the U.S. Route 29 Corridor in the basic employment and planned employment centers (Figure 4). Table 5 further describes the economic community.

b. Employment and Income

Table 5 defines the number of employees in various categories in the zones adjacent to U.S. Route 29. Employment within 1-1/2 miles of the Route is fairly evenly distributed between service, governmental/institutional, and industrial. By the year 2005, the service and industrial uses are predicted to have a greater proportion of the employment market. This growth will occur in the proposed basic employment areas, as discussed in the Land Use and Planning section and illustrated in Figure 4.

The Baltimore Regional Planning Council has generated data describing the commuter patterns for employees who reside in the UTPP zones adjacent to U.S. Route 29. Figure 8 illustrates the direction of movement and the number of corridor residents who work within the County and those who commute to jobs outside the County. Table 6 gives the percentage of employees who travel from the zonal areas to outside locations. The highest number of employees--43 percent--work within Howard County. Figure 8 shows that the direction of commuter traffic leaving the corridor is greatest in the south going toward Washington, D.C., Prince Georges County, and Anne Arundel County, and in the north moving toward Baltimore City and Baltimore County. Commuter movements southward account for approximately 9,000 commuters, or 29 percent of total commuters. Approximately 9,000 commuters also travel northward, on U.S. Route 29. Therefore, a total of 18,000 commuters, or 57 percent of all commuters, travel either north or south on U.S. Route 29. The majority of these trips occur during peak hours.

The average income for the project corridor in 1980 was \$32,000. The average income in Howard County in 1980 was approximately \$30,000. The average income for residents of the entire state was \$7,000 lower than the County average. Only 2.9 percent of County families were below the poverty level in 1979. In 1982, 6 percent of the total civilian labor force was unemployed in the County--over two percentage points lower than Maryland's unemployment rate.<sup>3</sup> The health of the study area economy is reflected in these findings.

c. Taxes and Revenue

The ability of the governing body to levy taxes on a community provides necessary revenue for community services. Residents of Howard County pay a variety of taxes, some dependent on the location of service areas, including county, fire, state, and metro. The local property tax feeds money back into the community. According to the County Office of Finance, the total assessed value of taxable land for Howard County as of February 1986 was \$2,254,029,776. At the 1985 taxing rate of \$2.49/\$1000 assessed value, total taxable land revenues equals \$58,379,369. Columbia also levies a "new town" fee of \$.75 for every \$100 of assessed value.

7. Natural Environment

a. Surface Water

U.S. Route 29 crosses over one drainage sub-basin within the Howard County study area: the Patuxent River Area. Table 7 lists the number of existing U.S. Route 29 crossings of each tributary and the approximate highway station locations of these crossings. A total of 15 existing stream crossings are found along the study corridor (See Detailed Alternates Mapping in Section

64

TABLE 5  
EMPLOYMENT CHARACTERISTICS AND PROJECTIONS  
1980-1990-2005

	<u>1980</u>	<u>1990</u>	<u>2005</u>
Total Employment	31,390	42,630	61,780
Retail Employment			
Number of Employees	5,260	7,210	10,360
Percent of Total Employment	17%	17%	17%
Service Employment <sup>a</sup>			
Number of Employees	9,260	14,250	21,450
Percent of Total Employment	29%	33%	35%
Office Employment			
Number of Employees	2,110	3,000	4,970
Percent of Total Employment	7%	7%	8%
Government Institution			
Number of Employees	7,350	8,250	10,030
Percent of Total Employment	23%	19%	16%
Industrial <sup>b</sup>			
Number of Employees	7,410	9,920	15,270
Percent of Total Employment	24%	23%	25%

Source: Cooperative Forecast/Round II Socioeconomic Data for 1980 US Census  
-- Baltimore Regional Planning Council

a Service includes financial institutions

b Industrial includes production line and heavy construction industries



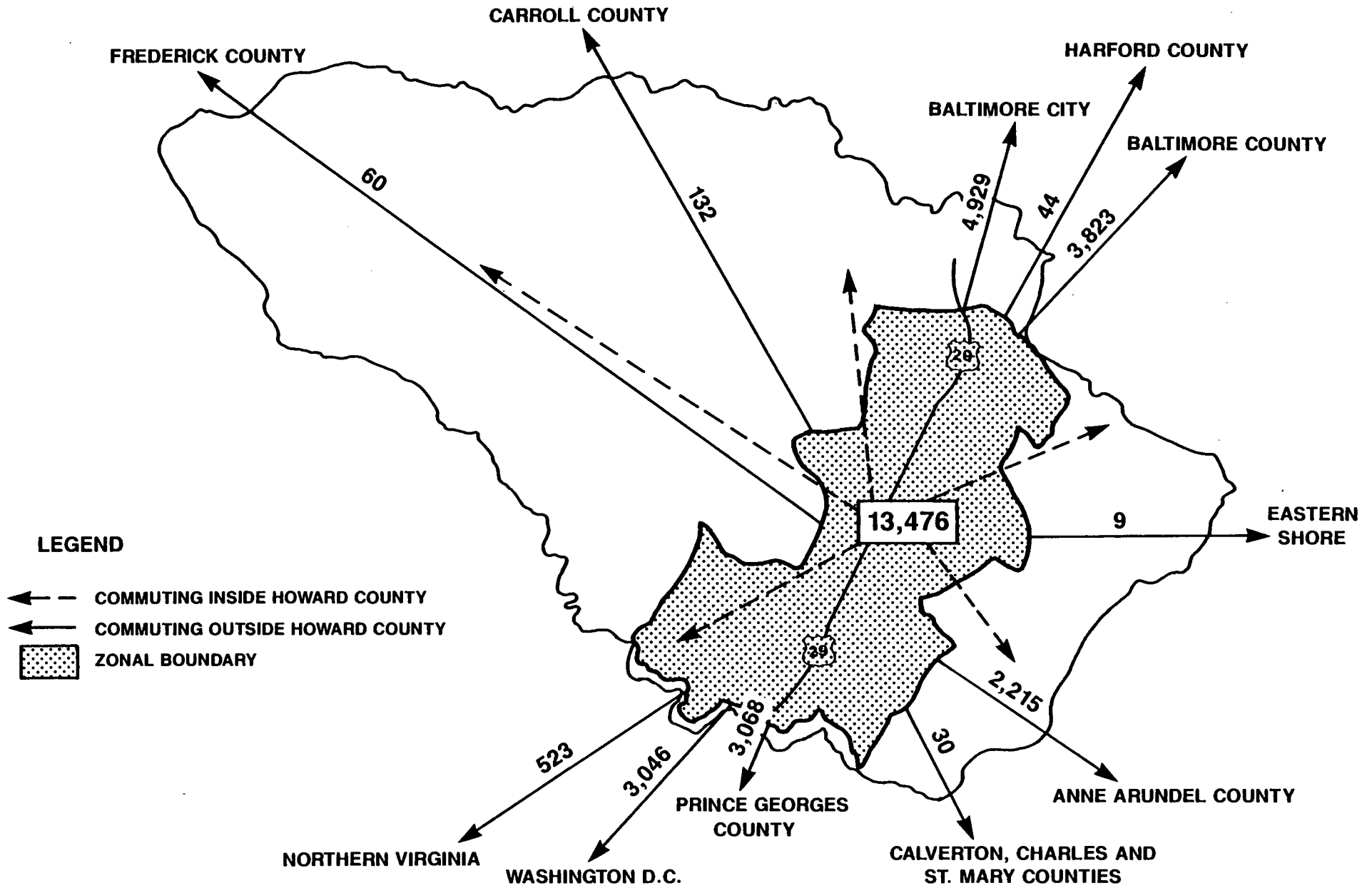

**FIGURE 8**  
Commuter Trips Per Day

65

64

TABLE 6  
 COMMUTER PATTERNS FROM U.S. ROUTE 29 CORRIDOR

<u>AREA</u>	<u>NUMBER OF COMMUTERS</u>	<u>PERCENT OF TOTAL COMMUTERS</u>
Baltimore City	4,929	16.00%
Baltimore County	3,823	12.00%
Anne Arundel County	2,215	7.00%
Carroll County	132	.40%
Harford County	44	.10%
Eastern Shore	9	.02%
Prince Georges County	3,068	10.00%
Northern Virginia	523	2.00%
Montgomery County	60	.20%
Washington, D.C.	3,046	10.00%
Calverton, Charles, St. Mary	30	.10%
Howard County	<u>13,476</u>	43.00%
TOTAL COMMUTERS	31,355	

TABLE 7  
U.S. ROUTE 29 STREAM INFORMATION

<u>TRIBUTARY</u>	<u>NUMBER OF TRIBUTARIES CROSSED BY U.S. ROUTE 29</u>	<u>APPROXIMATE STATION LOCATIONS OF CROSSINGS</u>
Patuxent River	3	640 670 675
Hammond Branch	1	735
Middle Patuxent River	2	795 815
Little Patuxent River	9	860 Between 865 and 870 Between 880 and 885 965 980 1000 Between 1010 and 1015 Between 1035 and 1040 1055
TOTAL STREAM CROSSINGS	15	

64

III). Many of these streams are small, intermittent streams that are conveyed under U.S. Route 29 in pipes or culverts. Several stream crossings were field-viewed in June 1986. It must be noted that the summer of 1986 was extremely dry. Note that the stream crossings along U.S. Route 29 which were included in previous studies for other projects are not included in this project. See Figure 2, Study Area Map, for these areas.

Of the 15 tributaries presently crossed by U.S. Route 29, only two are over 10 feet wide: Hammond Branch and Middle Patuxent River. The U.S. Route 29 crossing of the Hammond Branch is located in the vicinity of Hammond Drive near Station 735. (See Detailed Alternates Mapping, Sheet 2 of 8). The Hammond Branch passes under the roadway through an approximately 25-foot, twin-cell box culvert. When it was field-checked in June 1986, the main flow of the Hammond Branch was only 3 feet wide where it was adjacent to U.S. Route 29, but it expanded to about 20 feet wide where it flowed under the highway. The depth of water varied, but averaged approximately 3 inches. The stream bottom is silt; the banks are somewhat steep and vegetated.

The main crossing of the Middle Patuxent River is near the Johns Hopkins University Applied Physics Laboratory at approximately Station 795. (See Detailed Alternates Mapping, Sheet 3 of 8.) Two separate structures--one approximately 40 feet wide and the other about 55 feet wide--carry the two northbound and three southbound lanes, respectively, over the Middle Patuxent River. When it was field-checked in June 1986, the river was approximately 20 feet wide and 6 inches deep at its deepest point. The bottom of the stream is mainly silt. The banks are steep and paved beneath U.S. Route 29. In areas adjacent to the highway, the banks are vegetated.

In addition to these two large (over 10 feet) streams, U.S. Route 29 crosses 13 tributaries that are either intermittent or less than 10 feet wide. These tributaries, shown on the Detailed Alternates Mapping in Section III, occur at, or near, the following station locations on U.S. Route 29: 640, 670, 675, 815, 860, 865, 880, 965, 980, 1000, 1010, 1035, and 1055. All of these small tributaries are conveyed under U.S. Route 29 through culverts or pipes. As indicated on the mapping, several additional tributaries are located within the corridor but not crossed by U.S. Route 29. Detailed characteristics of these streams, including results of field investigations, are contained in the Natural Resources Technical Analysis Report supporting this Environmental Assessment.

Discharge rates compiled in the U.S. Geological Survey (USGS) publication "Water Resources Data, Maryland and Delaware, Water Year 1981,"<sup>4</sup> and discharge rates from three County sampling stations for 1978 were selected to represent water quantity along the study corridor. The mean discharge rate for the Patuxent River at the USGS Station at Laurel, Maryland, for the 1981 Water Year, was 27.0 cubic feet per second (cfs). The corresponding rate for the Little Patuxent River at the USGS Station at Guilford, Maryland, was 25.1 cfs. The locations of the three County sampling stations are given in Table 8. As shown in this table, the flow of Hammond Branch was 1.2 cfs, the flow of Middle Patuxent River was 20.0 cfs, and the flow of Little Patuxent River was 22.3 cfs.

Surface waters along the project corridor also include Lake Kittamaqundi and five small ponds. (Refer to the Detailed Alternates Mapping; Sheets 1 and 4 of 8 show the ponds; Sheet 6 of 8 shows Lake Kittamaqundi.) Lake Kittamaqundi is a man-made lake in southern Columbia. The Lake is over 3,000

TABLE 8  
STUDY AREA WATER QUALITY DATA

Station ID	Description	Flow cfs	Fecal Coliform mpn/100 ml	Dissolved Oxygen mg/liter	Temperature °C	pH	Turbidity MG/L (FTU)
HAM 0039 <sup>1</sup>	Hammond Branch at Leishear Rd., East of U.S. Route 29		1458*	10.9	16.4	---	3.8
MXT 0152 <sup>1</sup>	Middle Patuxent River at Tridelphia Road	1.2	1358*	10.4	13.7	7.1	7.8
MXT 0021 <sup>1</sup>	Middle Patuxent River at Murray Hill Road Bridge		468*	10.6	12.4	7.1	7.5
MTX 0051 <sup>1</sup>	Middle Patuxent River at Kindler Rd., East of U.S. Route 29	20.0	520*	10.3	16.7	---	3.5
LXT 0173 <sup>1</sup>	Little Patuxent River at U.S. Route 1 Bridge		668*	10.8	17.2	7.6	33.5
LXT 0200 <sup>1</sup>	Little Patuxent at Route 32 near U.S.G.S. gauging station	22.3	455*	10.4	14.2	7.2	23.5
UEG 0011 <sup>1</sup>	Tributary to Little Patuxent River just above Wilde Lake		461*	10.5	14.5	7.1	5.0
UEG 0005 <sup>1</sup>	Tributary to Little Patuxent River just below Wilde Lake		268*	8.9	16.6	7.2	9.3
LXT 0222 <sup>1</sup>	Little Patuxent River at Old Annapolis Road just north of MD Route 108		496*	10.1	14.3	7.3	7.9
WSSC	Rocky Gorge		3.0	0.8	19.5	6.9	6.8 <sup>3</sup>

\* Denotes violation of Maryland Receiving Water Quality Standards

- 1 1978 Howard County Data
- 2 August, 1983 WSSC Data
- 3 Secchi Depth

I-43

69

70

feet long and approximately 800 feet at its widest point. It is fed by the Little Patuxent River. More detail is provided on the lake and ponds in Section I.C.7.c., Wetlands.

The Maryland Water Use Classification for each tributary is given in Table 9. The quality of water in Maryland is regulated by COMAR 10:50, Maryland Receiving Water Quality Standards.<sup>5</sup> The code cites seven parameters to be used to establish water quality. These parameters include both chemical and bacteriological elements considered in water quality. The parameters are: 1) fecal coliform density, 2) dissolved oxygen, 3) water temperature, 4) pH, 5) turbidity, 6) toxic materials and 7) total residual chlorine.

Data collected from nine County stations and one WSSC station were examined to determine water quality for the U.S. Route 29 Study Corridor.<sup>6</sup> Table 8 lists the water quality data and location for each of the selected sampling stations. Water quality for the Rocky Gorge Reservoir was obtained from the Washington Suburban Sanitary Commission Study "Patuxent River Reservoir Water Quality Assessment," printed in March of 1984.<sup>7</sup> Data collected from the WSSC Rocky Gorge water quality monitoring station is given in Table 8.

Data collected at the sampling stations shows a violation of total fecal coliforms at all stations, with the exception of the Rocky Gorge Reservoir. Dissolved oxygen, temperature, pH, and turbidity levels were all within the parameters set forth in water quality standards. Rocky Gorge was well within the parameters for total fecal coliform, but violated the dissolved oxygen standard. Testing results for the toxic materials and total residual chlorine concentration was not included in the published sampling data for the County or the WSSC study.

As noted in Table 9, study area streams are capable of supporting aquatic life. Most streams are able to sustain warm water fish species. The Patuxent River, designated as Class IV, is capable of supporting trout populations; however, according to sampling conducted by the Maryland Department of Natural Resources (MD DNR) Tidewater Administration in 1980 and 1981, no trout were found in the river.

Sampling programs by MD DNR indicate a variety of fish and macroinvertebrate species in the Patuxent River, Rocky Gorge Reservoir, Middle Patuxent River, Little Patuxent and Hammond Branch. Amphibians and reptiles associated with habitats in the study area included a variety of salamanders, toads, frogs, snakes and turtles. The complete listing of these species is contained in the Natural Resources Analysis Report prepared for this project.

The Glassy darter (Etheostoma vitreum), designated as rare by the Maryland Natural Heritage Program, is found in the Middle Patuxent River at the U.S. Route 29 crossing. The rare amphipods Stygobromus t. patomacus and Stygobromus pizzinii are found in a few small streams adjacent to U.S. Route 29 just south of its intersection with U.S. Route 40 (See May 28, 1986 WRA letter in Section V). There are no federally listed or proposed threatened or endangered aquatic species in the highway corridor (See USFWS Jan. 25, 1985 letter in Section V).

TABLE 9  
MARYLAND WATER USE CLASSIFICATIONS FOR  
U.S. ROUTE 29 ASSOCIATED TRIBUTARIES

<u>TRIBUTARY</u>	<u>DRAINAGE SUB-BASIN</u>	<u>MARYLAND WATER USE CLASSIFICATION</u>
Patuxent River (Rocky Gorge Reservoir)	Patuxent River Area	IV-Recreational Trout Waters
Hammond Branch	Patuxent River Area	I-Water Contact Recreation and Aquatic Life
Middle Patuxent River	Patuxent River Area	I-Water Contact Recreation and Aquatic Life
Little Patuxent River	Patuxent River Area	I-Water Contact Recreation and Aquatic Life

72

b. Groundwater

Much of the groundwater in Howard County lies near the surface in relatively thin soil overburden or between shallow rock formations. The majority of Howard County, including the entire project area, is within the Piedmont province. The Piedmont province in this area is underlain by crystalline rocks. Because of their large areal extent, the crystalline rocks are the most important aquifers in Howard County. Although crystalline rocks, as a group, are not very porous, the groundwater accumulates in these rocks in joints and fractures. The size of joints, and hence the amount of water in them, varies considerably. Practically all of the groundwater in the County occurs under water table conditions, with artesian conditions occurring locally.

The two geological formations found in the project area are the Wissahickon formation oligoclase-mica facies and Guilford granite. The majority of the project area is within the Wissahickon formation. However, the area between Maryland Route 32 and the northern end of Lake Kittamaqundi is within the Guilford formation. The yields of these two formations in Howard County generally range from 8 to 14 gallons per minute, and the depth of wells average between 40 and 120 feet.<sup>9</sup> Domestic water supplies of these two formations are available practically everywhere in Howard County, with larger supplies available in some areas.

Groundwater is the primary source of potable water available to residents outside the service areas of the Washington Suburban Sanitary Commission and Howard County. Because aquifers in the nonservice areas are not extensive or highly productive, groundwater supplies are sensitive to environmental changes.

c. Wetlands

National Wetlands Inventory (NWI) maps were initially reviewed to identify wetlands in the area. Additionally, a field view was conducted in October 1986, with the U.S. Fish and Wildlife Service and various agencies within the Maryland Department of Natural Resources to verify the location and classification of wetlands. The 20 project area wetlands were classified in accordance with the U.S. Fish and Wildlife Service system (FWS/OBS-79/31). Wetlands in the project corridor are associated with the stream crossings, Lake Kittamaqundi, and the five small ponds. All wetlands in the project area are nontidal. Each wetland is numbered and its classification given in Table 10. The location of each wetland is shown on the Detailed Alternates Mapping in Section III. It must be noted that wetlands within the areas previously studied (See Figure 2, Study Area Map) are not included in this analysis.

The largest wetland, other than open water, is Wetland #16, located northeast of Lake Kittamaqundi. (See Detailed Alternates Mapping, Sheet 6 of 8.) This wetland is classified as Palustrine, Forested, Broad-Leaved Deciduous, Temporarily Flooded. Most of the wetlands adjacent to the project area streams have this classification. They are Wetlands #1, #3, #5, #12, and #13. Palustrine, Forested, Broad-Leaved Deciduous, Temporarily Flooded wetlands are characterized by woody vegetation six meters or taller. Typical dominant species include red maple (*Acer rubrum*), black willow (*Salix nigra*), and river birch (*Betula nigra*). These three species were observed during the June 1986 field view of Wetlands #3, #5, #12, and #13 shown on Sheets 1, 2, 3, 4, and 5 of 8, respectively, in the Detailed Alternates Mapping. Other species of



TABLE 10  
U.S. ROUTE 29 WETLANDS

WETLAND #	US FISH & WILDLIFE SERVICE CLASSIFICATION	LOCATION
1	PF01A	Patuxent River tributary just east of main branch
2	POWZh	Pond east of U.S. Route 29 near Harding Road
3	PF01A and PEM5A	Hammond Branch (main branch)
4	R2OWH	Middle Patuxent River (main flow)
5	PF01A	Areas adjacent to Middle Patuxent River
6	PSS1A	Middle Patuxent tributary at Rivers Edge Road
7	POWZx	Pond at Maryland Route 32
8	POWZh	Pond south of Seneca Drive
9	POWFh	Pond south of Seneca Drive
10	POWZh	Pond south of Seneca Drive
11	PSS1A	Little Patuxent tributary south of Seneca Drive, east of U.S. Route 29
12	PF01A	Little Patuxent tributary south of Seneca Drive, west of U.S. Route 29
13	PF01A	Little Patuxent tributary at Gales Lane
14	R2OWH	Little Patuxent river (main flow) west of U.S. Route 29
15	L1OWHh	Lake Kittamaquondi
16	PF01A	Large wetland area northeast of Lake Kittamaquondi
17	PEM5A	Little Patuxent tributary south of Wandering Way
18	PSS1A	Little Patuxent tributary south of Maryland 175
	EM5A	
19	PSS1A	Little Patuxent tributary at Maryland 175 ramps
	EM5A	
20	PSS1A	Little Patuxent tributary at Diamondback Drive
	EM5A	

PF01A = Palustrine, Forested, Broad-Leaved Deciduous, Temporarily Flooded  
PSS1A = Palustrine, Scrub/Shrub, Broad-Leaved Deciduous, Temporarily Flooded  
PEM5A = Palustrine, Emergent, Narrow-Leaved Persistent, Temporarily Flooded  
R2OWH = Riverine, Lower Perennial, Open Water, Permanently Flooded  
L1OWHh = Lacustrine, Limnetic, Open Water, Permanently Flooded, Diked/Impounded  
POWZx = Palustrine, Open Water, Intermittently Exposed/Permanently Flooded, Excavated  
POWZh = Palustrine, Open Water, Intermittently Exposed/Permanently Flooded, Diked Impounded  
POWFh = Palustrine, Open Water, Semi-permanently Flooded, Diked/Impounded

H

vegetation observed at these wetlands included: black locust (Robinia pseudoacacia), boxelder (Acer negundo), silver maple (Acer saccharinum), yellow poplar (Liriodendron tulipifera), and gray birch (Betula populifolia). The understory of this wetland type was observed to contain honeysuckle (Lonicera spp.), fox grape (Vitis labrusca), dewberry (Rosa flagellaris), and sweet cicely (Osmorhiza claytoni).

Wetlands #6 and #11 (See Detailed Alternates Mapping, Sheet 3 and 4 of 8) are classified as Palustrine Scrub/Shrub Broad-Leaved Deciduous, Temporarily Flooded. These wetlands are characterized by woody vegetation less than six meters tall, and include tree shrubs, young trees, and trees or shrubs that are small or stunted as a result of environmental conditions. Typical dominant species include alder (Alnus spp.), willow (Salix spp.), buttonbush (Cephalanthus spp.), and young trees such as red maple (Acer rubrum).

Wetland #17 (See Detailed Alternates Mapping, Sheet 6 of 8) and a portion of Wetland #3 (See Detailed Alternates Mapping, Sheet 2 of 8) are classified as Palustrine Emergent, Narrow-Leaved Persistent, Temporarily Flooded. This type of wetland is characterized by erect, rooted, herbaceous hydrophytes. They are dominated by species that normally remain standing at least until the beginning of the next growing season. Dominant species include grasslike plants such as cattails (Typhus spp.), bulrushes (Scirpus spp.), sawgrass (Caladium jamaicense), sedges (Carex spp.) and various true grasses. Emergent species observed during the field view of this wetland included various grasses, joe-pye-weed, and impatiens.

Wetlands #18, #19, and #20 (See Detailed Alternates Mapping, Sheet 6 and 7 of 8) support a combination of wetland types Palustrine Scrub/Shrub, Broad-Leaved Deciduous, Temporarily Flooded and Palustrine, Emergent, Narrow-Leaved Persistent, Temporarily Flooded. Species observed during the June 1986 field view of these wetlands included: young black willow trees and shrubs, young red maples, young box elders (Acer negundo), swamp rose (Rosa palustris), bristly locust (Robina hispida), and emergents such as sedges, rushes, and sweetflag (Acorus calamus).

The open water of Lake Kittamaqundi, Wetland #15, (See Detailed Alternates Mapping, Sheet 6 of 8) is classified as Lacustrine, Limnetic, Open Water, Permanently Flooded, Diked/Impounded. This wetland type includes all deep-water habitats that are situated in a depression or dammed river channel; that lack trees, shrubs, and persistent emergents; and that have a total area of 20 acres. Wetlands of smaller size are also included if the shoreline makes up all or part of the boundary, or if the water depth of the deepest point exceeds 2 meters (6.6 feet) at low water.

The Middle Patuxent River, Wetland #4, (See Detailed Alternates Mapping, Sheet 3 of 8) and the Little Patuxent River west of U.S. Route 29 near Lake Kittamaqundi, Wetland #14 (See Detailed Alternates Mapping, Sheet 6 of 8), are the two largest streams in the project area. The open water of both these wetlands is classified as Riverine, Lower Perennial, Open Water, Permanently Flooded. This wetland is characterized by open water that is usually flowing and has a low gradient, a slow velocity, and a well-developed floodplain.

The open water of the small ponds numbered as Wetlands #2, #8, and #10 (See Detailed Alternates Mapping, Sheets 1 and 4 of 8) are classified as Palustrine, Open Water, Intermittently Exposed/Permanently Flooded

Diked/Impounded. Pond #7 (See Detailed Alternates Mapping, Sheet 4 of 8) is classified as Palustrine, Open Water, Intermittently Exposed/Permanently Flooded, Excavated; and Pond #9 (See Detailed Alternates Mapping, Sheet 4 of 8) is classified as Palustrine, Open Water, Semi-Permanently Flooded, Diked/Impounded. Palustrine Open Water, Diked/Impounded or Excavated wetlands are bodies of water with basins that vary from being intermittently exposed and permanently flooded to semipermanently flooded, depending on the water regime and local water sources. This classification can include decorative landscaping ponds, sedimentation ponds, and stormwater management facilities.

d. Floodplains

The Patuxent River at the U.S. Route 29 crossing is controlled by WSSC's Rocky Gorge Reservoir. The elevation of the 100-year floodplain of this impoundment is controlled by the operation of Rocky Gorge Dam.

The floodplains in Howard County are being restudied by the Federal Emergency Agency; thus information on these floodplains are from ongoing studies. Preliminary mapping from these studies was obtained from the Howard County Department of Public Works. In addition to the Patuxent River, the 100-year floodplains of Hammond Branch, Middle Patuxent River, and Little Patuxent River are crossed by U.S. Route 29. The Detailed Alternates Mapping in Section III, Sheets 2, 3, and 5 of 8, shows the 100-year floodplains of these three streams. The majority of U.S. Route 29 was constructed on fill, with roadway elevations above the base (100-year) floodplain elevation, and therefore, not subject to inundation by the 100-year flood. An exception, as shown in Alternates Mapping, is a portion of U.S. Route 29 near Lake Kittamaqundi, which is within the Little Patuxent 100-year floodplain.

The 100-year floodplain of Hammond Branch is approximately 400 feet wide in the vicinity of U.S. Route 29, but narrows to about 25 feet where it passes under the roadway. The Middle Patuxent River's 100-year floodplain is approximately 650 feet wide adjacent to U.S. Route 29, but becomes narrower, to about 100 feet, where it passes under the U.S. Route 29 bridge. A 1,500-foot-long section of U.S. Route 29, between the South Entrance to Columbia and the southern end of Lake Kittamaqundi, is located in the 100-year floodplain of the Little Patuxent River. Also, the Little Patuxent River floodplain is adjacent to, or within 150 feet of, U.S. Route 29 for a length of about 2500 feet near Lake Kittamaqundi.

e. Vegetation

Several vegetative land cover types exist along the U.S. Route 29 corridor. These land covers, identified in a separate study<sup>8</sup> for this project, include: man-dominated, abandoned field shrub, agricultural, and hardwood forest. Table 11 describes each type and lists representative plant species. A complete listing of plants associated with these vegetative cover types that are expected to occur within the corridor or that are observed during on-site ecological investigations is contained in the Natural Resources Analysis Report prepared for this project.

The man-dominated land cover typically is found in the residentially developed areas of the project corridor. One such area is most of the area between the Middle Patuxent River and Maryland Route 108 (including

76

TABLE 11  
VEGETATIVE HABITATS

<u>HABITAT</u>	<u>DESCRIPTION</u>	<u>REPRESENTATIVE PLANTS</u>
Man Dominated	Mowed aprons, lawns, and residential gardens	Grasses, broad-leaved herbaceous species, and landscaping trees and shrubs
Abandoned Field Shrub	Areas not subject to mowing for at least the current growing season and subject to invasion of woody species	Herbaceous species, shrubs (such as sumac, blackberry and dogwood), trees (such as black locust, Virginia pine, wild cherry and pin oak)
Hardwood Forest	Areas where >50% of the area was dominated by trees; mostly immature hardwoods	Oaks, wild cherry, yellow poplar, black locust, hickories, elm, sycamore
Agricultural	Areas maintained for annual crop production or pasturing; includes hedgerows and drainage ways	Crops (hay, corn and soybeans), pasture (grasses, legumes, and herbaceous plants)

Columbia). There are also pockets of man-dominated habitat throughout the project area.

Abandoned field shrub areas are located in the less developed areas of the corridor, mainly in Segment VI. This habitat type also is found in the area immediately south of Lake Kittamaquidi, and occupies most of the project area north of Maryland Route 175.

Hardwood forests are found adjacent to the streams and the lake, and in many of the less developed areas along the corridor. Much of Segment VI is comprised of hardwood forests.

Several large cultivated areas exist between the Montgomery/Howard County line and Maryland Route 32. Few cultivated areas are found in the remainder of the U.S. Route 29 Corridor.

According to the U.S. Fish and Wildlife Service, no federally listed or proposed endangered or threatened plant species are known to exist in the area (See letter in Section V).

#### f. Wildlife

Habitats within the corridor support a variety of wildlife. A complete listing of wildlife likely to inhabit the area is contained in the Natural Resources Analysis Report prepared for this project. Although the study corridor is narrow and adjacent to an existing heavily traveled highway, the habitats could be utilized for feeding, cover, and travelways. It is expected that some birds and small mammals would utilize the habitats within the corridor on a consistent basis, while the larger and more mobile mammals such as the raccoon, opossum, and white-tailed deer would use study corridor habitats primarily as travelways.

Some mammal species that may utilize all of the habitat types, including the man-dominated type, are: striped skunk, raccoon, opossum, and cottontail rabbit. Other species expected to utilize only the more rural areas are: red fox, grey fox, and white-tailed deer.

The forested habitat would be expected to support the grey squirrel, white-footed mouse, and the Eastern chipmunk. The abandoned field shrub habitat would be expected to support populations of woodchuck, cottontail rabbit, meadow vole, and the meadow jumping mouse. These four species also may be found in agricultural areas, but probably in lesser densities. In addition to the species that may occur throughout the corridor, the house mouse and Norway rat are known to be found in association with buildings and human activities.

Mammals associated with corridor waterways include the muskrat, mink, and possibly the beaver and river otter. It is unlikely, however, that these last two species would utilize the corridor habitat on a permanent basis.

Many species of birds would be expected to utilize corridor habitats for nesting, resting, and/or feeding. Nesting, however, may be restricted to those species tolerant of traffic noise. Species observed in the study corridor include: nighthawk, house sparrow, crow, rock dove, mourning dove, and cardinal.

78

A complete list of mammals, birds, amphibians, and reptiles found in the study area is provided in the Natural Resources Analysis Report prepared for this project.

According to the U.S. Fish and Wildlife Service, no federally listed or proposed endangered or threatened animal species are known to exist in the area, except for occasional transient individuals. Coordination with the Maryland Department of Natural Resources also revealed no threatened or endangered wildlife species in the study area. (See USFWS and MD DNR letters in Section V).

g. Farmland

The majority of the study corridor is located in the Glenelg-Chester-Manor soil association. These soils dominate nearly 50 percent of the total soils in Howard County and are characterized as deep, well-drained, gently sloping, and sloping soils. Intense farming is common, and these soils are suitable for row, hay, and forage crops. Other agricultural uses include orchards and pastures.

Glenelg-Manor-Chester soils also are well-suited for agricultural purposes, including dairying, livestock, and cultivated and forage crops. Commercial farming on Relay-Brandywine-Legore soils is limited to small pastures and isolated crops.

Prime farmland includes all Soils of Statewide Importance and Prime Farmland soils that are not already in or committed to urban use. The Natural Resources Analysis Report contains a listing and mapping of Prime Farmland Soils and Soils of Statewide Importance. The majority of soils along the U.S. Route 29 Corridor is classified as prime farmland. Most of the southern portion of the corridor, between the County line and Maryland Route 32, is fairly undeveloped, and much of it is planned for conservation purposes. Several large cultivated areas exist along this portion of the corridor, as shown on the Land Use Map (Figure 3). The remainder of the corridor is residential, or planned for development (refer to Section I.C.1., Land Use and Planning). However, few cultivated areas are located along this northern portion of the corridor.

h. Visual Environment

The study corridor is characterized by medium-density residential development separated by large areas of agricultural or open space. From the County line to Maryland Route 32, the corridor is predominately rural. Residential areas are found north of Maryland Route 32, and urban development intensifies between Columbia and Ellicott City.

Rural open areas, including abandoned fields, agricultural land, and forested areas, provide pleasant scenery. Other open spaces providing visual amenities along the roadway include areas surrounding the Middle Patuxent River and the Little Patuxent River.

The most valuable natural area in the corridor is the Rocky Gorge Reservoir. This area contains a large freshwater impoundment area surrounded by mature hardwoods up to 50 feet high. Since the reservoir lies in a wide valley, it is easily visible from both northbound and southbound U.S. Route 29.

### 8. Existing Noise Levels

Eight noise-sensitive areas, designated A through H, have been identified along the U.S. Route 29 Corridor. These areas are primarily of residential use and are shown in Figure 9. All of the areas are classified as Category B use which includes the following: picnic areas, recreation areas, playgrounds, active sports areas, parks, residences, motels, hotels, schools, churches, libraries, and hospitals. The FHWA Noise Abatement Criteria (NAC) for this category is 67 decibels (dBA).

In May 1986, a noise monitoring program was conducted at 11 representative ground level exterior monitoring sites in each sensitive area. Details of the measurement procedures are provided in the Noise Analysis Report supporting this EA. These monitoring sites are described in Table 12 and shown in Figures 10 through 17. Table 13 lists the sites in each Noise Sensitive Area where noise impacts were modeled for future conditions. These sites are also shown on Figures 10 through 17. Worst-case traffic noise occurs at level of service (LOS) "C" conditions, the combination of traffic volume and speed that produces the maximum noise level from traffic operation. To avoid traffic in excess of LOS "C" volumes which occurs during morning and evening peak traffic periods, measurements were taken between 9:00 A.M. and 4:00 P.M. Traffic volumes observed during most of the noise measurements were well below LOS "C" levels. The measured noise levels then were adjusted to reflect the worst-case existing noise levels at LOS "C" volumes.

As Table 12 indicates, noise levels ranged from 60 dBA to 71 dBA at the eleven monitored sites. Five sites met or exceeded the FHWA NAC of 67 dBA, and three other sites approached the NAC (65-66 dBA).

The dominant source of noise in the study area was traffic on U.S. Route 29. Rivers Edge Road at Noise Monitoring Site C-5 (Figure 12) and Old Columbia Road at Noise Monitoring Site D-2 (Figure 13) were two sites at which secondary traffic contributed significantly to the overall noise environment. During the field study conducted at Noise Monitoring Site H-1 (Figure 17), construction activity associated with the Maryland Route 108 interchange interfered with the noise measurement. Consequently, the measured noise levels probably are higher than normal at the site.

### 9. Existing Air Quality

The project area is located between the modifying influences of the Chesapeake Bay and Atlantic Ocean to the east and the Appalachian Mountains to the west. The net effect is a more uniform climate compared with locations farther inland at the same latitude.

The annual prevailing wind direction is from the west. Wind speeds are generally less during the night and early morning hours, and increase to a maximum in the afternoon.

The project area is in the Metropolitan Baltimore Interstate Air Quality Control Region.

TABLE 12  
EXISTING NOISE LEVELS FROM NOISE MONITORING SITES

<u>NOISE SENSITIVE AREA</u>	<u>NOISE MONITORING SITE</u>	<u>DESCRIPTION OF MONITORING SITE</u>	<u>L<sub>eq</sub> (dBA)</u>
A	A-1	Scaggs House, residence	64
B	B-5	Hillcrest Heights at Hillcrest Drive, residence	71*
	B-4	Hammond Village west of Tralee Court, residence	60
C	C-5	Riverside Estates at Rivers Edge Road, residence	66
D	D-2	Arrowhead, at Bush Ranger Path, residence	68*
E	E-3	River Meadows at Rosinante Road, residence	70*
F	F-1	Tor Apartments, apartments	64
	F-4	Autumn Crest, north of Tor Apartments, apartments	67*
	F-8	Kelly's Store, historical/residence	68*
G	G-1	Guilford Downs at Pepple Road, residence	66
H	H-1	Columbia Hills at West Hills Road, residence	65

\* Meets or exceeds NAC



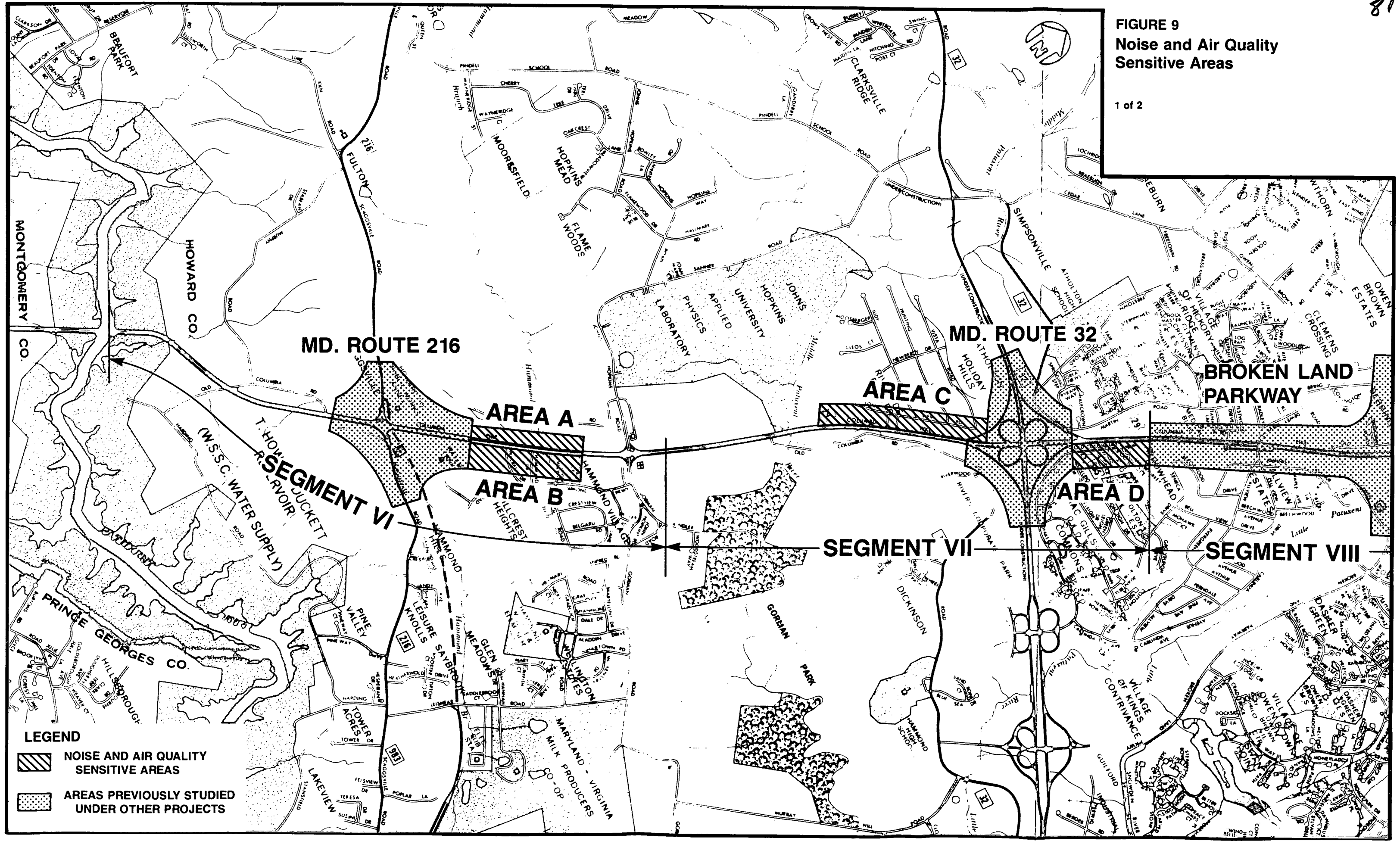

FIGURE 9  
Noise and Air Quality  
Sensitive Areas

1 of 2



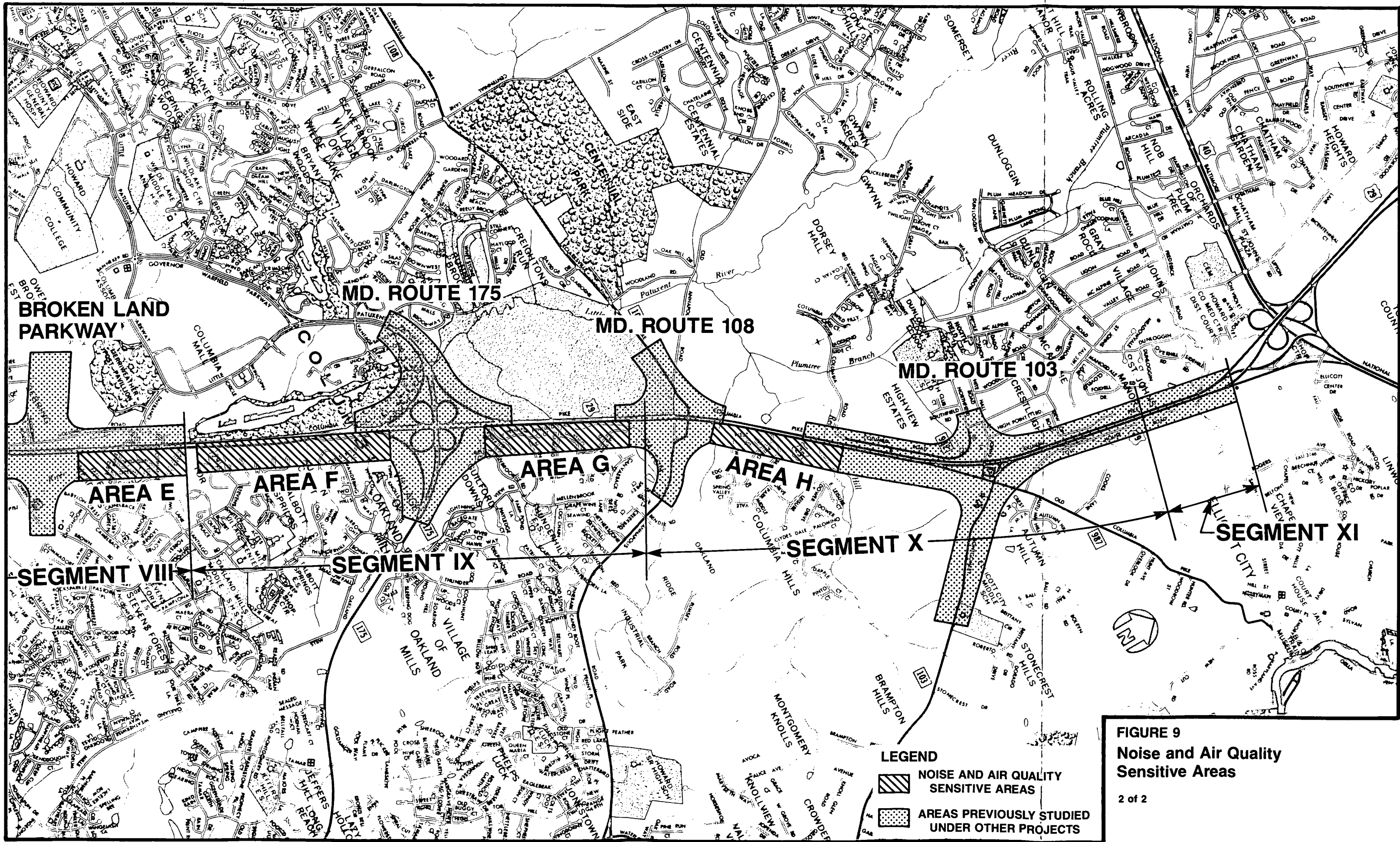

**LEGEND**

-  **NOISE AND AIR QUALITY SENSITIVE AREAS**
-  **AREAS PREVIOUSLY STUDIED UNDER OTHER PROJECTS**

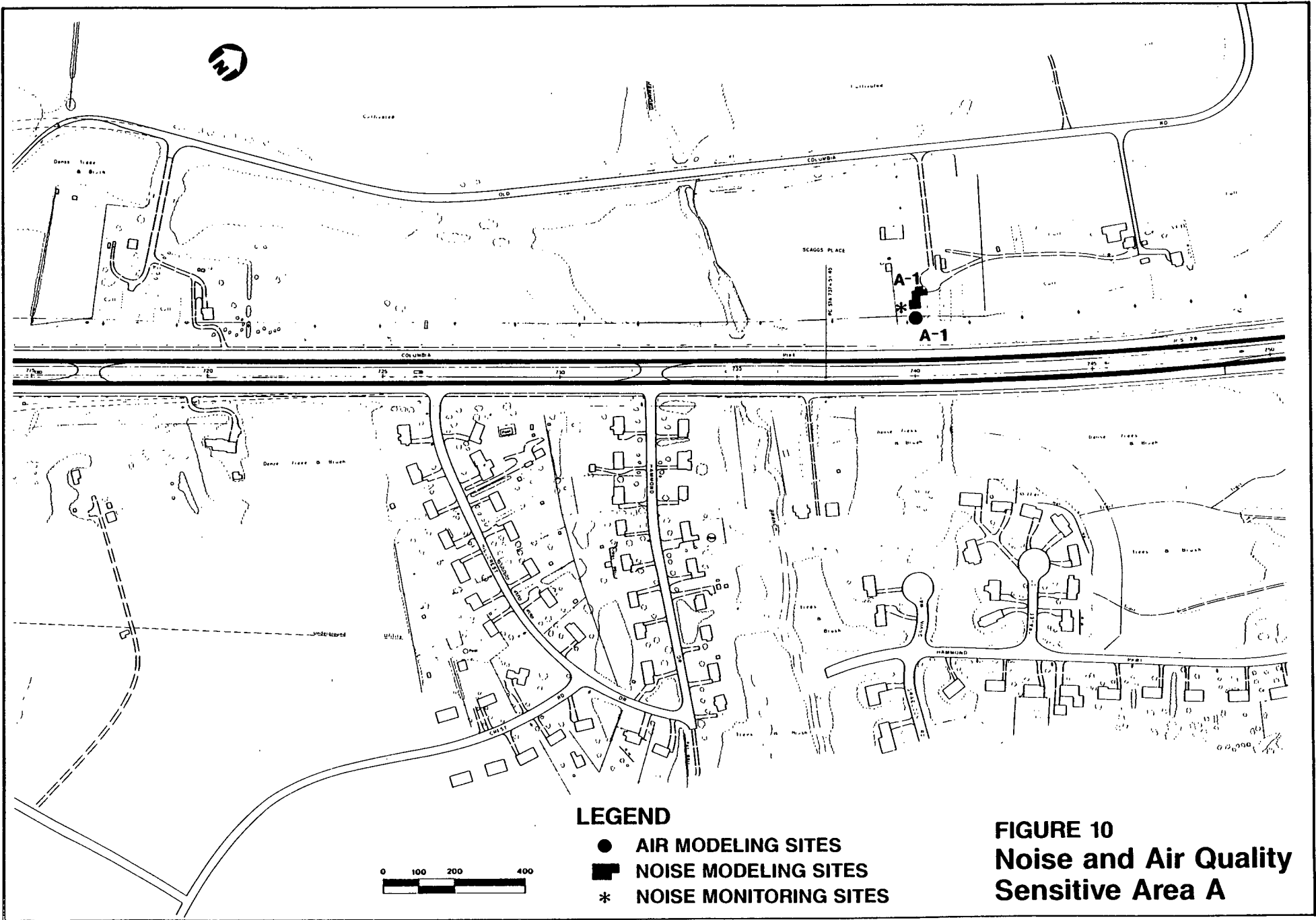

**FIGURE 9**  
**Noise and Air Quality Sensitive Areas**  
 2 of 2

**LEGEND**

-  NOISE AND AIR QUALITY SENSITIVE AREAS
-  AREAS PREVIOUSLY STUDIED UNDER OTHER PROJECTS

I-59



**LEGEND**

- AIR MODELING SITES
- NOISE MODELING SITES
- \* NOISE MONITORING SITES

**FIGURE 10**  
**Noise and Air Quality**  
**Sensitive Area A**

53

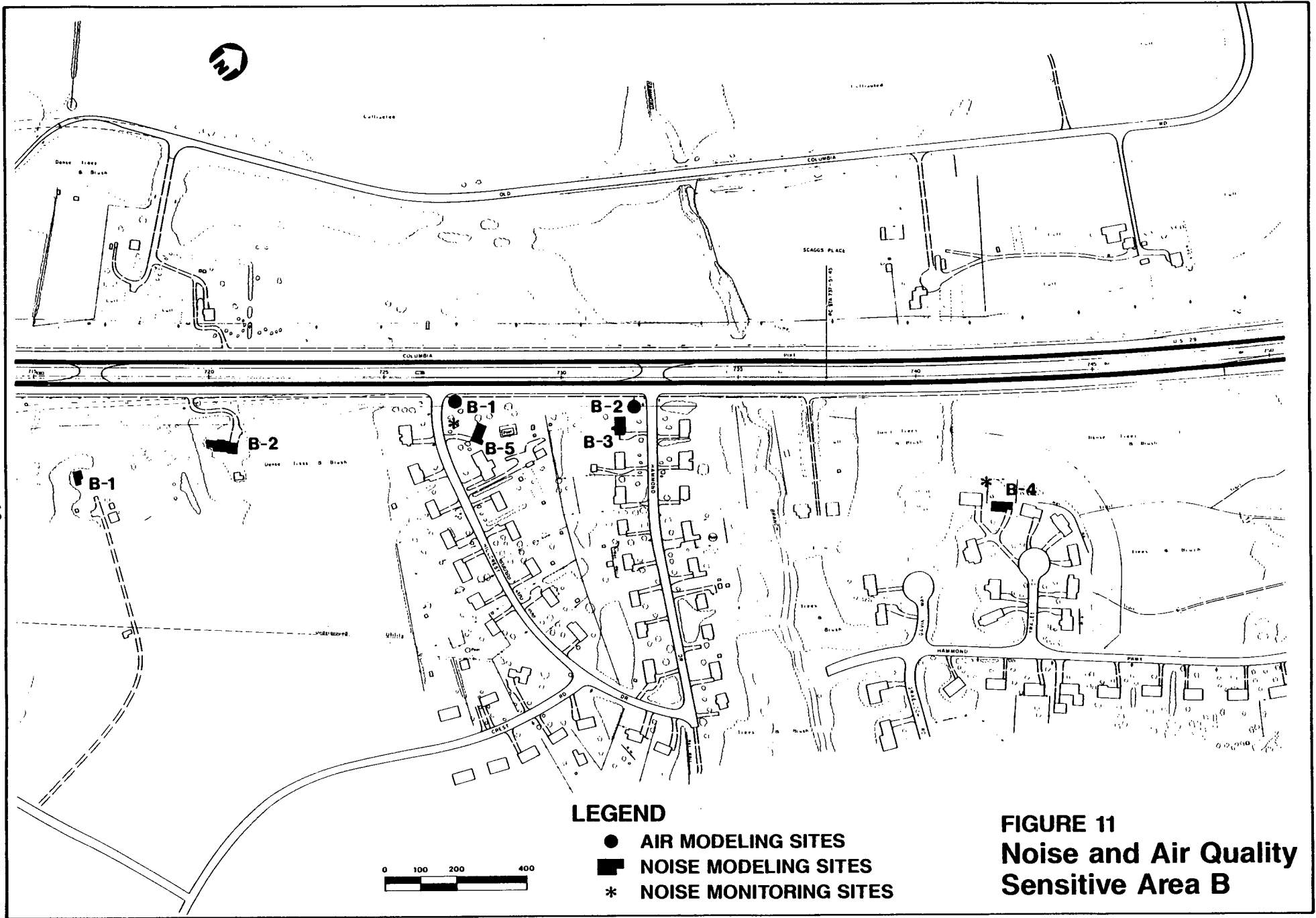

09-1

**LEGEND**

- AIR MODELING SITES
- NOISE MODELING SITES
- \* NOISE MONITORING SITES

**FIGURE 11**  
**Noise and Air Quality**  
**Sensitive Area B**

h8

I9-I

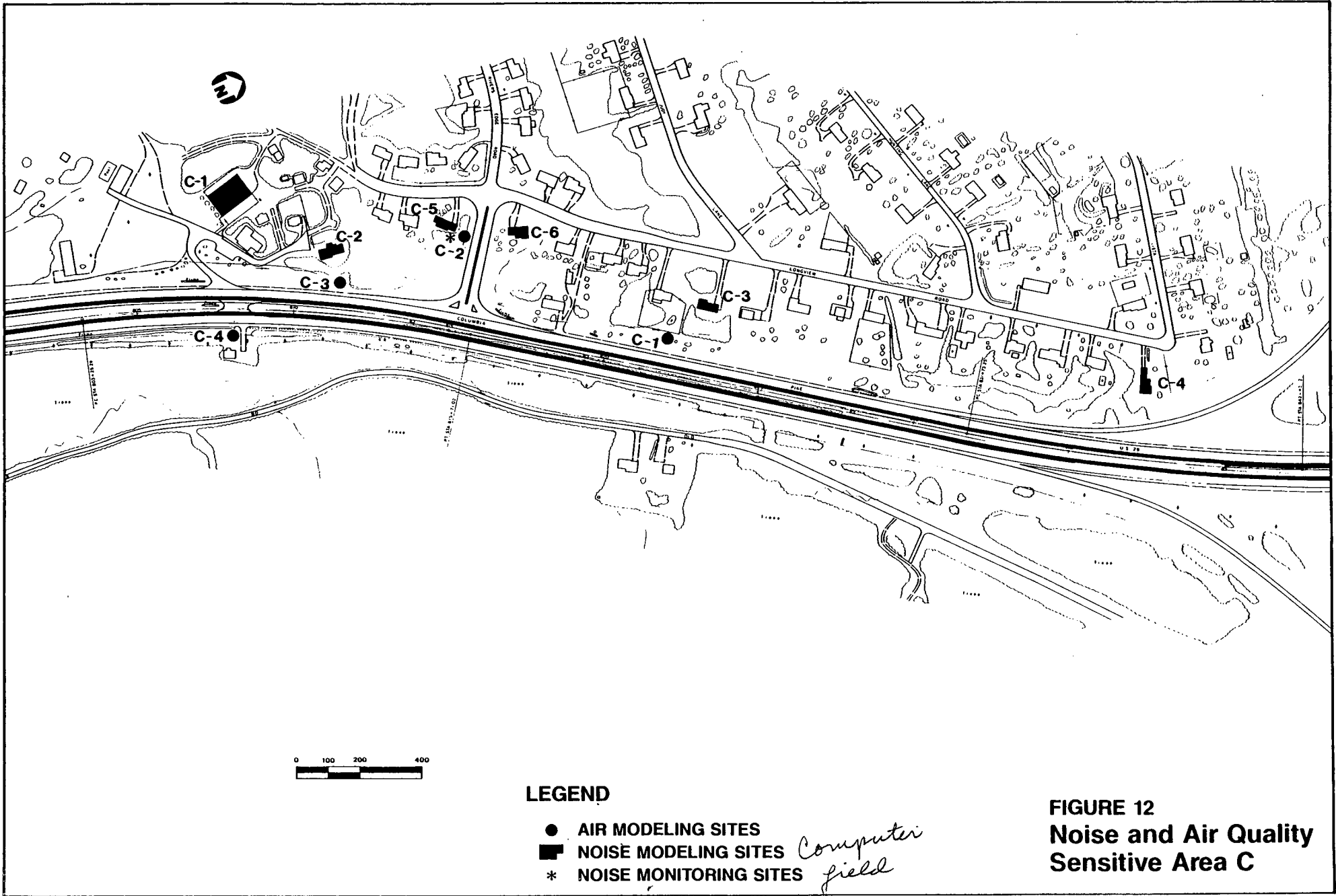

**LEGEND**

- AIR MODELING SITES
  - NOISE MODELING SITES
  - \* NOISE MONITORING SITES
- Computer field*

**FIGURE 12**  
**Noise and Air Quality**  
**Sensitive Area C**

85

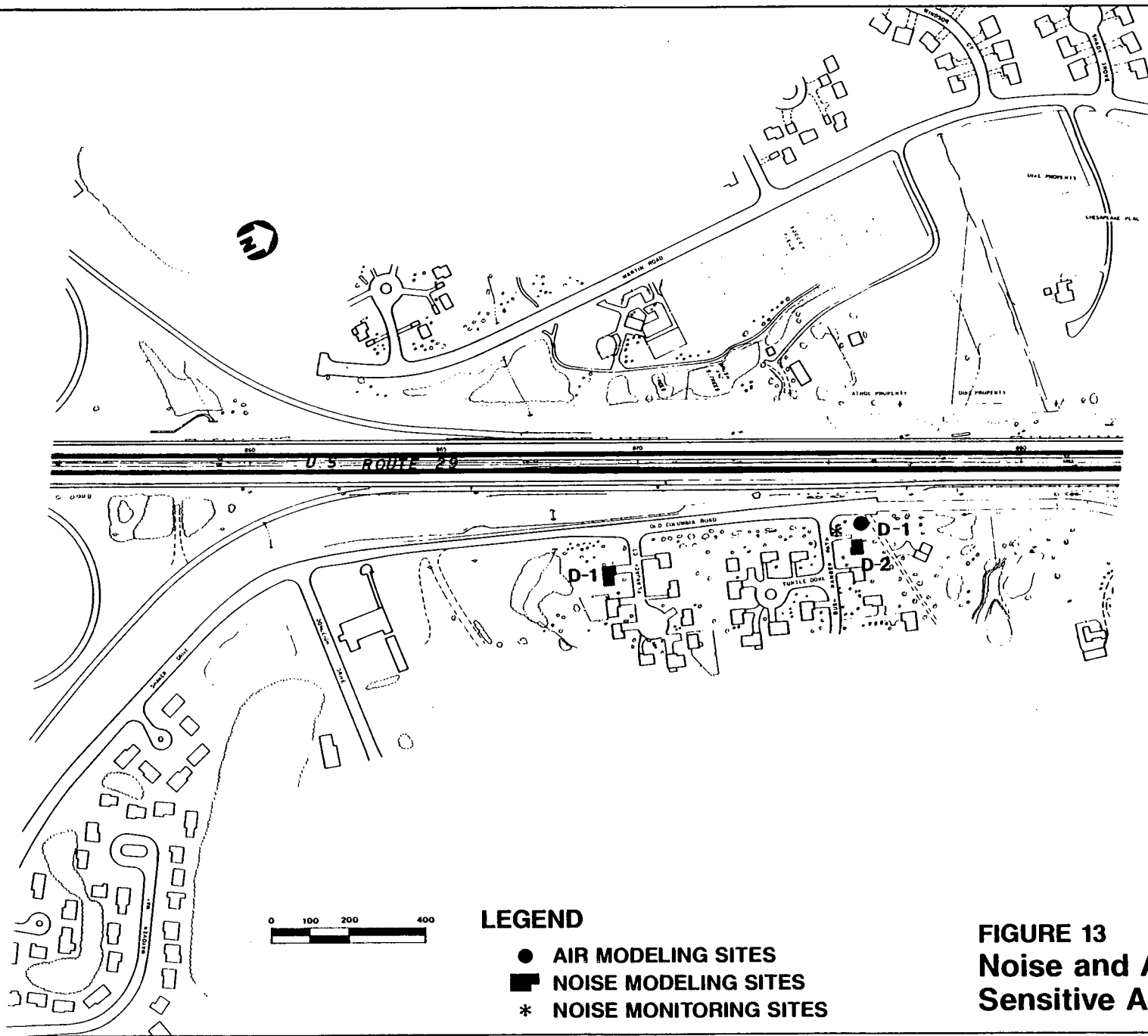

D-2  
 ●  
 AT SENECA DR

**LEGEND**

- AIR MODELING SITES
- NOISE MODELING SITES
- \* NOISE MONITORING SITES

**FIGURE 13**  
**Noise and Air Quality**  
**Sensitive Area D**

*Handwritten signature or initials*

I-63

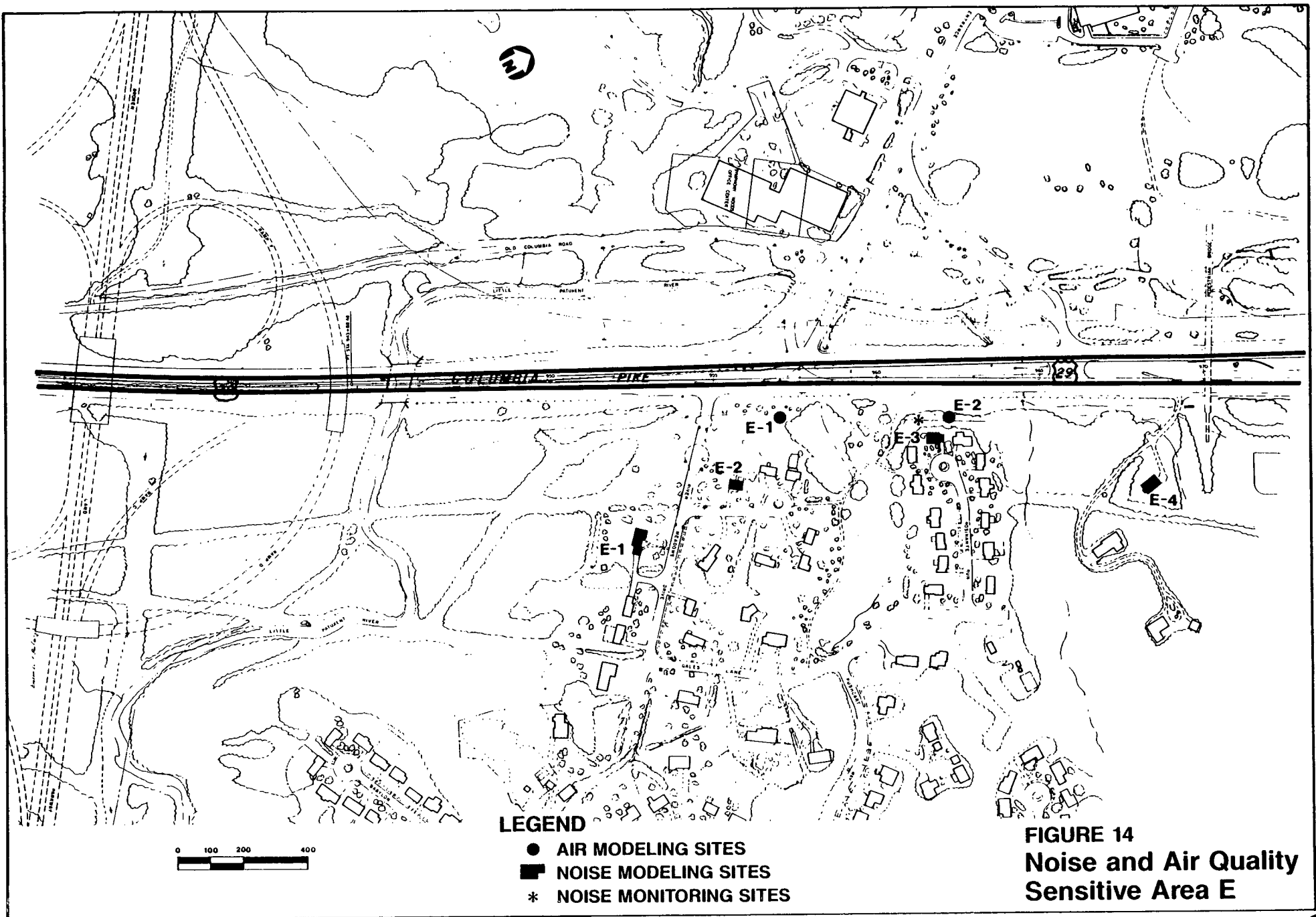

I-64

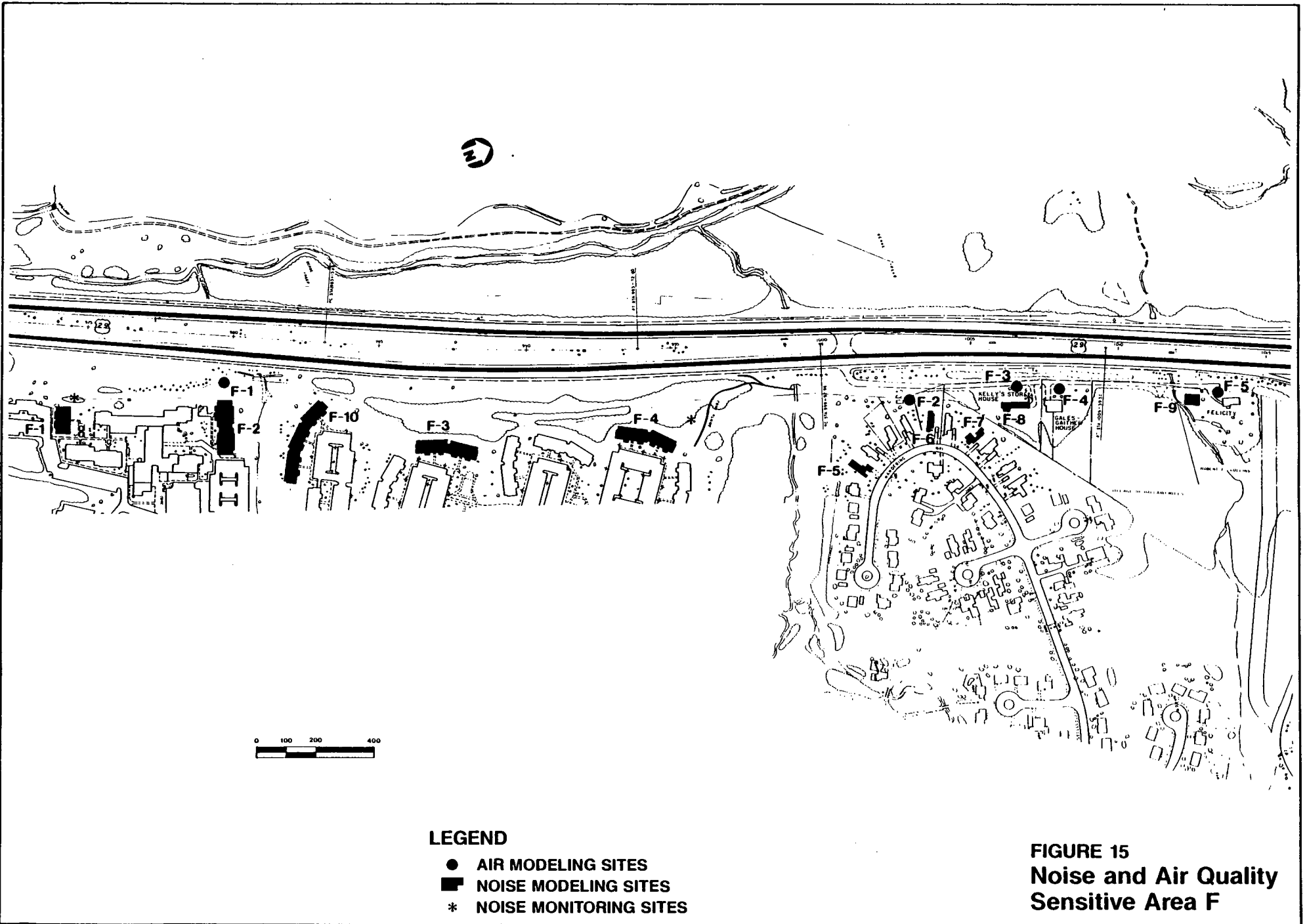

**LEGEND**

- AIR MODELING SITES
- NOISE MODELING SITES
- \* NOISE MONITORING SITES

**FIGURE 15**  
**Noise and Air Quality**  
**Sensitive Area F**

88



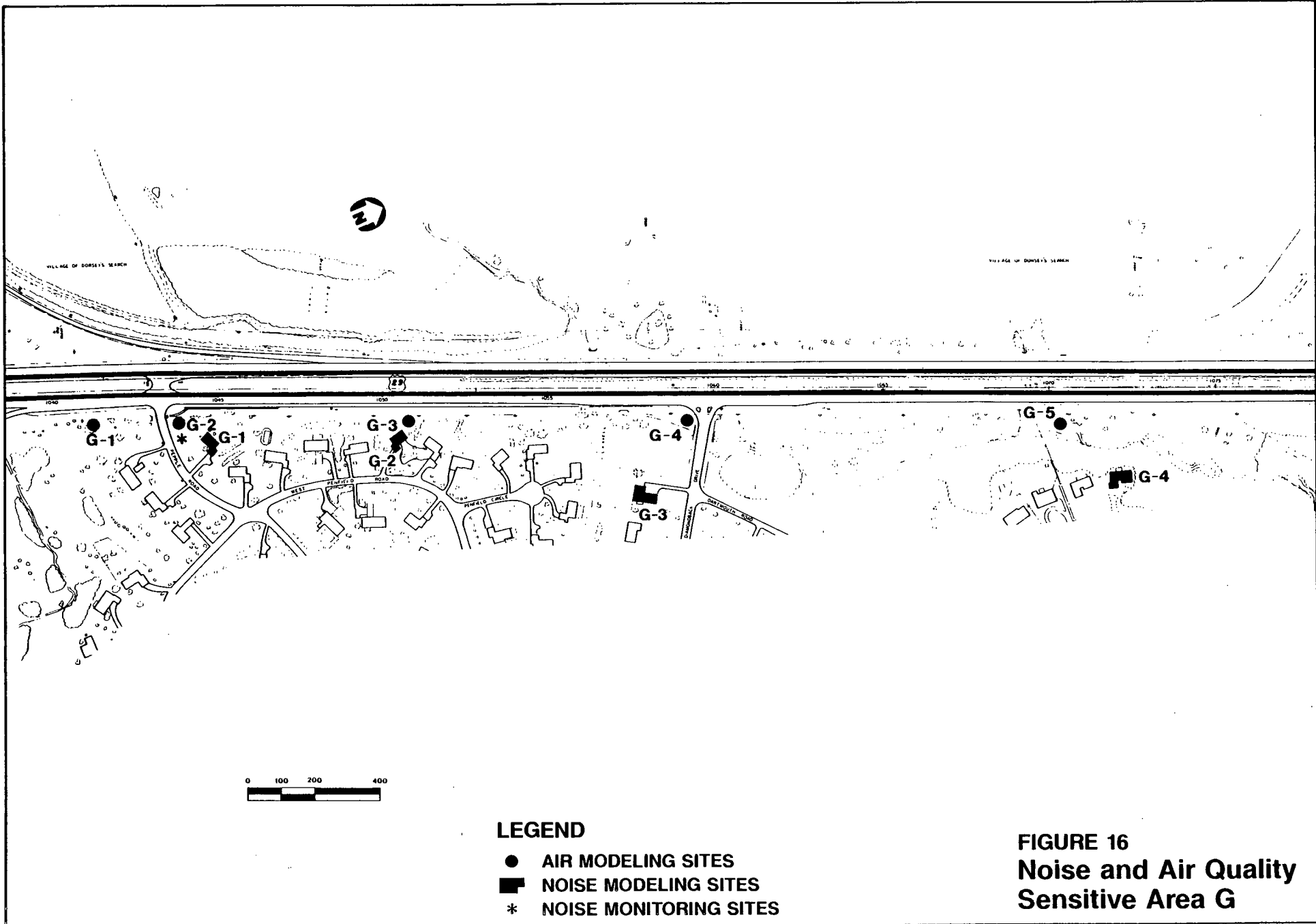

**LEGEND**

- AIR MODELING SITES
- NOISE MODELING SITES
- \* NOISE MONITORING SITES

**FIGURE 16**  
**Noise and Air Quality**  
**Sensitive Area G**

68

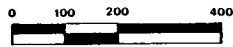
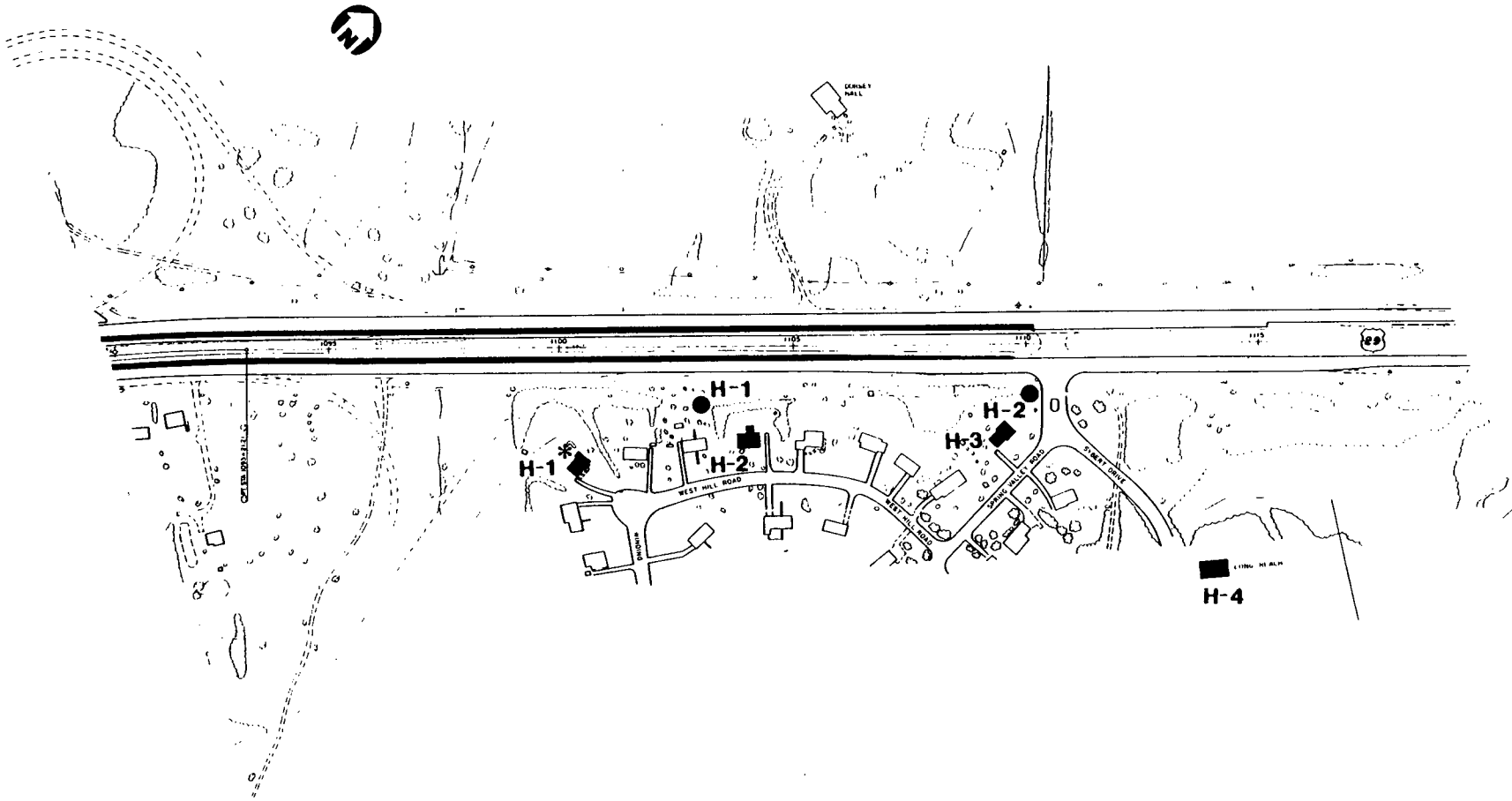

**LEGEND**

- AIR MODELING SITES
- NOISE MODELING SITES
- \* NOISE MONITORING SITES

**FIGURE 17**  
**Noise and Air Quality**  
**Sensitive Area H**

99

TABLE 13  
NOISE MODELING SITES

NOISE SENSITIVE AREA	NOISE MODELING SITE	<u>DESCRIPTION OF MODELING SITE</u>
B	B-1	Residence south of Hillcrest Heights
	B-2	Residence south of Hillcrest Heights
	B-3	Residence, Hillcrest Heights at Hammond Drive
C	C-1	Church of God State Headquarters, office
	C-2	Riverside Estates, south of River Edge Road, residence
	C-3	Riverside Estates at Longiew Road, residence
	C-4	Riverside Estates at Vista Road, residence
	C-6	Riverside Estates at Rivers Edge Road, residence
D	D-1	Arrowhead at Flapjack Court, residence
E	E-1	River Meadows, south of River Meadows Drive, residence
	E-2	River Meadows at Offshore Green, residence
	E-4	Residence at Gales Lane
F	F-2	Tor Apartments
	F-3	Autumn Crest Apartments
	F-5	Oakland Mills, on Wandering Way, residence
	F-6	Oakland Mills, on Wandering Way, residence
	F-7	Oakland Mills, on Wandering Way, residence
	F-9	Felicity, historical/residence
	F-10	Autumn Crest Apartments
G	G-2	Guilford Downs on West Penfield Road, residence
	G-3	Guilford Downs at Diamondback Road, residence
	G-4	Dalton on Dalton, residence
H	H-2	Columbia Hills on West Hill Road, residence
	H-3	Columbia Hills at Spring Valley Road, residence
	H-4	Columbia Hills on Sybert Drive, residence

SECTION II

A. PURPOSE

The Howard County Office of Planning and Zoning developed a set of transportation goals in 1982. These goals were:

- . U.S. Route 29 should be upgraded to a principal arterial highway with four or more travel lanes, with median and right-of-way equaling 200 to 300 feet.
- . Primary function of the highway is service not access.
- . Intersecting road traffic should be controlled by interchanges.
- . The following intersections should be replaced with grade-separated interchanges: Maryland Route 216, Hopkins/Gorman Road, Maryland Route 32, Little Patuxent Parkway, Maryland Route 108, Maryland Route 103, and Broken Land Parkway.

Attainment of these goals would meet the future growth objectives of establishing efficient transportation and promoting private economic growth as set forth in the Howard County General Plan.

The transportation problem in the study area is the inability of the existing corridor to properly handle the existing and projected traffic. The present roadway operates above capacity during the A.M. and P.M. peaks. The existing signals along the U.S. Route 29 corridor were put in to handle the crossing and turning movements at these more heavily congested areas. As a result of the influx in traffic and the future projected growth, these areas are at capacity and can no longer efficiently handle the traffic. The study of these areas will reflect the need for grade-separated intersections that can handle higher capacities.

In addition to the need to move people along the corridor, there is also the need to accommodate those people who wish to cross U.S. Route 29 on foot. Each of the locations studied addresses the efficient movement of pedestrian traffic.

In implementing the layout for fully controlled access, the existing road network on each side of U.S. Route 29 must be examined to ensure that safe and efficient local traffic circulation is maintained. Parts of the existing local network must be upgraded, and new two-lane links with shoulders must be included as an element of this study.

The U.S. Route 29 corridor is a vital part of a complex transportation network serving Howard County. This corridor has undergone extensive industrial-commercial development, and in the next 20 years is expected to experience continued growth in planned commercial, industrial, and residential development. Therefore, the purpose of the U.S. Route 29 project is to ensure that sufficient, safe roadway capacity will be provided to accommodate the traffic growth that is anticipated.

B. PROJECT BACKGROUND

Old Columbia Pike, which intersected the Frederick Turnpike in Ellicott City, was one of the earliest roadways in Howard County. When the route was

originally designated as U.S. Route 29, it followed what is now Maryland Route 108 south to Olney, where it turned to parallel what is now New Hampshire Avenue to White Oak. At White Oak, the Route again followed Old Columbia Pike into the District of Columbia.

In the early 1950s, the State Roads Commission planned and began construction of a new dual highway along the Old Columbia Pike Corridor. In Howard County, only one-half of this new roadway was constructed. By 1954, the new bridge over the Patuxent River was completed, thus opening the facility for through traffic. In 1968, the connection north of St. Johns Lane to I-70 was completed. Development of the new town of Columbia necessitated the construction of dual lanes on the New Columbia Pike. The new construction was completed in 1970. Although not fully achieved, access to and from New Columbia Pike was controlled so that the facility could one day evolve into a freeway.

Since completing the original dual highway, the State Highway Administration has refined the corridor in many locations to provide additional capacity. An interchange and an extension of Maryland Route 175 have replaced the original north entrance to Columbia at Oakland Mills Road. The Patuxent Freeway has replaced old Maryland Route 32. Construction activities have begun for an interchange at Maryland Route 108. Final design activities are underway for new interchanges at Maryland Route 216 and proposed Maryland Route 103 at St. John's Lane. Preliminary studies are under development for an interchange at the proposed Broken Land Parkway, which includes Owen Brown Road and Columbia's South Entrance. North of St. John's Lane, the roadway has been widened to six lanes.

U.S. Route 29 is a major route utilized by public transportation services in the Baltimore/Washington metropolitan area. Fixed-route transit, commuter bus, and demand-responsive services operate within and through Howard County.

ColumBus and the Eyre's/Trailways system are the fixed-route services operating in the area. ColumBus is a privately-supported system operating in Columbia, while the Eyre's/Trailways system operates exclusively along U.S. Routes 29 and 40. Expansion of the ColumBus system is feasible.

The primary source of public transportation is the commuter bus service, which transports residents of the metropolitan area into the city employment centers. Three bus firms offer commuter services to residents along the U.S. Route 29 corridor.

Numerous ride-sharing programs originate in Howard County via carpooling, vanpooling, and park-and-ride lots. Park-and-ride lots are located on U.S. Route 29 at Maryland Route 103, Maryland Route 216, and the Broken Land Parkway.

Improvement of the major intersections along U.S. Route 29 is a long-range goal of the State Highway Administration. In conjunction with this goal, the U.S. Route 29/Maryland Route 103 intersection is considered by Howard County elected officials as one of their highest transportation improvements priorities.

The 1982 Highway Needs Inventory lists improvements to the U.S. Route 29/Maryland Route 103 interchange as a part of its study. In addition, the 1982 Howard County Master Plan includes the improvement of this intersection in its transportation plan.

94

This project is included in the Maryland Department of Transportation's Consolidated Transportation Program (CTP) for 1984-1989, with construction tentatively scheduled to begin in Fiscal Year 1989.

### C. EXISTING AND PROJECTED TRAFFIC CONDITIONS

This project included a detailed traffic analysis. Traffic volume data and detailed results are presented in the Appendix.

U.S. Route 29 is among the more important primary highways in Howard County and is the only one serving the City of Columbia. The growth in traffic volumes over the past thirty-five years along U.S. Route 29 has generally paralleled the growth in households and employment.

Historical Traffic Volumes (vehicles per day) are tabulated below for a few selected sections of U.S. Route 29 in Howard County:

	<u>1950</u>	<u>1960</u>	<u>1970</u>	<u>1980</u>
North of Maryland Route 216	696	6,050	15,000	22,600
North of Maryland Route 32	716	5,711	19,000	28,998
North of Maryland Route 108	2,695	7,950	25,000	40,600

Current daily traffic volumes (vehicles per day) and hourly traffic volumes (vehicles per hour) are tabulated in Table 14 for the six segments of U.S. Route 29 studied in Howard County. Current daily traffic volumes and A.M. and P.M. peak-hour traffic volumes for each intersection in the study area are shown in Appendix A. The peak hour directional distribution is 62% A.M. southbound and 63% P.M. northbound. The A.M. and P.M. peak hours are 5.24% and 5.49%, respectively, of the average daily traffic.

In accordance with the projected increases in land use in the study area, year 2015 traffic volumes are anticipated to significantly increase in comparison to today's volumes. Tabulated in Table 15 are year 2015 daily and peak-hour traffic volumes for each study segment in Howard County. Daily year 2015 traffic volumes and A.M. and P.M. peak-hour traffic volumes for each intersection in the study area are shown in the Appendix.

The existing truck usage comprises 5% of the average daily traffic (ADT) and A.M. and P.M. peak-hour traffic and will remain the same percentage for the design year of 2015.

Quality of traffic flow along a highway is measured in terms of level of service (LOS). This measure is dependent upon highway geometry and traffic characteristics, and ranges from LOS "A" (Best), to LOS "C" (minimum desirable), to "E" (Capacity), to LOS "F" (worst or forced flow). The LOS categories and descriptions are:

LOS A is free flow, with low volumes and high speeds.

LOS B is the zone of stable flow, with operating speeds beginning to be restricted somewhat by traffic conditions; drivers, however, still have reasonable freedom to select their speed and lane of operation.

LOS C is still in the zone of stable flow, but speeds and maneuverability are more clearly controlled by the higher volumes.

TABLE 14  
1985 TRAFFIC DATA

<u>SEGMENT</u>	<u>LOCATION ALONG U.S. ROUTE 29</u>	<u>AVERAGE DAILY TRAFFIC VOLUME</u>	<u>PEAK HOUR TRAFFIC VOLUME</u>
VI	Howard County Line to North of Hopkins/Gorman Road	27,800	380
VII	North of Hopkins/Gorman Road to North of Maryland Route 32	31,400	2,985
VIII	North of Maryland Route 32 to Columbia's South Entrance	38,500	3,675
IX	Columbia's South Entrance to Maryland Route 108	47,900	4,380
X	Maryland Route 108 to North of Maryland Route 103	54,100	5,225
XI	North of Maryland Route 103 to U.S. Route 40	55,400	5,555

TABLE 15  
DESIGN YEAR 2015 TRAFFIC DATA

<u>SEGMENT</u>	<u>LOCATION ALONG U.S. ROUTE 29</u>	<u>AVERAGE DAILY TRAFFIC VOLUME</u>	<u>PEAK HOUR TRAFFIC VOLUME</u>
VI	Howard County Line to North of Hopkins/Gorman Road	50,100	4,995
VII	North of Hopkins/Gorman Road to North of Maryland Route 32	51,800	4,955
VIII	North of Maryland Route 32 to Columbia's South Entrance	78,500	6,675
IX	Columbia's South Entrance to Maryland Route 108	92,100	6,835
X	Maryland Route 108 to North of Maryland Route 103	104,400	9,005
XI	North of Maryland Route 103 to U.S. Route 40	119,700	9,120

LOS D approaches unstable flow, with tolerable operating speeds being maintained though considerably affected by changes in operating conditions.

LOS E cannot be described by speed alone, but represents operations at even lower operating speeds than in level D, with volumes at or near capacity of the highway.

LOS F describes forced flow operation at low speeds, where volumes are below capacity.

Section III of this report describes the Alternates being considered. Mapping of the alternates is included in that Section. Alternate A is the No Build, with the existing highway remaining as it currently exists plus those projects presently under development. Alternate B consists of widening U.S. Route 29, within the median, from four to six lanes and maintaining existing at-grade signalized intersections, except for those slated for improvement under other projects. Alternate C consists of widening U.S. Route 29 within the median, from four to six lanes, plus various concepts at intersections to control access through grade separation.

The Appendix (Section VI) contains detailed results of the level of service analysis for the existing condition and for Alternate A and Alternate B for 2015 for each intersection on U.S. Route 29 in Howard County. When a LOS F is shown, the volume-to-capacity ratio (v/c) is also listed to indicate the severity of the intersection breakdown. For example, if v/c=1.25, capacity is exceeded by 25%. Results of the traffic analysis indicate extremely congested conditions (LOS F) at many intersections by year 2015 with Alternates A or B. These alternates would not meet future transportation demand for the corridor.

Section VI also contains results of the levels of service analysis for the Alternate C concepts studied for year 2015. The level of service for freeway segments, ramps, intersections and weaves are tabulated. The traffic studies included an analysis of number of lanes required to meet future traffic demand within the corridor. Results clearly indicate a need for at least three lanes (in each direction). Levels of service F were projected in the study area for two lanes on the mainline at the following locations:

1. Northbound U.S. Route 29 south of Seneca Drive in Segment VIII, Concepts 3, 4, 5, 5a, and 5b.
2. Southbound U.S. Route 29 north of Seneca Drive in Segment VIII, Concepts 3, 4, 5, 5a, and 5b.
3. Northbound U.S. Route 29 south of Diamondback Drive in Segment IX, Concepts 1 and 3
4. Northbound and Southbound U.S. Route 29 at Spring Valley Road in Segment X, Concept 2.

Widening to three lanes alleviates this breakdown condition, and Alternate C presently includes this widening.

Results of the capacity analysis indicate Alternate C would result in acceptable traffic flow conditions for future projected traffic volumes. At all but two locations, the freeway mainline would operate at LOS C, or better, conditions. LOS D would exist on the northbound lanes in Segment VIII south of Seneca Drive during the P.M. peak period for Concepts 3, 4, 5, 5a, and 5b. In



Segment X, where projected traffic volumes are highest, LOS D is projected on both the northbound and southbound lanes at Spring Valley Road during the P.M. peak period for Concept 2. LOS E is projected at this location on the southbound lanes during the A.M. peak period.

The right-on, right-off Alternate C concepts result in LOS E for Ramps Proper at the following locations due to the low design speed (15 mph) of the right-on, right-off ramps:

1. Old Columbia Road Segment VI, Concept 1
2. Hammond-Hillcrest Segment VI, Concept 1
3. Seneca Drive Segment VIII, Concepts 3, 4, 5, 5a, and 5b
4. Gales Lane Segment VIII, Concept 1
5. Old Columbia Road Segment IX, Concept 1
6. Pepple-Diamondback Road Segment IX, Concept 1

Volumes 1 to 1,250 passenger cars per hour (pcph) result in a LOS E for a design speed of 15 mph. The maximum volume on any ramp listed above is 202 pcph on the northbound exit ramp at Seneca Drive.

**D. EXISTING AND PROJECTED SAFETY CONDITIONS**

U.S. Route 29, from the Patuxent River Bridge to U.S. Route 40 in Howard County, experienced 471 accidents during the three-year period of 1983 to 1985. This number resulted in an average accident rate of 106 accidents per 100 million vehicles miles of travel (acc/100MVM), which is lower than the weighted statewide average accident rate of 149acc/100MVM. The corresponding accident cost to the motoring and general public as a result of these accidents is approximately \$756,000/100MVM.

As indicated in Tables 16 and 17, the three-year accident rates by accident severity and collision type are consistent with the corresponding statewide average rates for this type of roadway.

As shown in Table 16, this segment of highway experienced two fatal accidents:

- . A pedestrian was struck while walking in the right-turn lane of northbound U.S. Route 29 at Maryland 216.
- . A driver, who had been drinking, drove his vehicle southbound in the northbound lane and struck a northbound vehicle.

There were two sections and five intersections that met the criteria for High Accident Locations (HAL) from 1983 to 1985. These locations are listed in Tables 18 and 19.

At-grade intersections are experiencing the greatest number of conflicts and accidents. Of 471 accidents, 265 (or 56%) were intersection-related accidents. As traffic volumes increase, at-grade intersections would experience an increase in congestion, delay, and number of accidents. Implementation of Alternate C will result in an accident rate approaching 71 acc/100 MVM.

TABLE 16  
ACCIDENT RATES BY ACCIDENT SEVERITY,  
1983-1985

<u>SEVERITY</u>	<u>NUMBER OF ACCIDENTS</u>	<u>RATE/100MVM</u>	<u>STATEWIDE AVERAGE RATE</u>
Fatal Accidents	2	0.5	1.6
Injury Accidents	273	61.2	83.8
Property Damage Only	196	44.0	64.0
Total Accidents	471	105.6	149.0

TABLE 17  
ACCIDENT RATES BY COLLISION TYPE,  
1983-1985

<u>COLLISION TYPE</u>	<u>NUMBER OF ACCIDENTS</u>	<u>RATE/100MVM</u>	<u>STATEWIDE AVERAGE RATE</u>
Opposite Direction	7	1.6	2.1
Rear End	205	46.0	48.1
Left Turn	40	9.0	17.1
Sideswipe	32	7.2	12.7
Angle	70	15.7	24.7
Pedestrian	5	1.1	2.5
Fixed Object	42	9.4	19.1
Parked Vehicle	4	0.9	2.3
Other Collisions	66	14.8	20.2

TABLE 18  
HIGH ACCIDENT LOCATIONS-HIGHWAY SECTIONS,  
1983-1985

<u>SECTION</u>	<u>YEARS LISTED</u>
.12 mile south of Vista Road to .18 mile north of Maryland 32	1985
.23 mile south of Owen Brown Road to .27 mile north of Owen Brown Road	1983

TABLE 19  
HIGH ACCIDENT LOCATIONS-INTERSECTIONS  
1983-1985

<u>SECTION</u>	<u>YEARS LISTED</u>
U.S. Route 29 at Johns Hopkins/Gorman Road	1983, 1985 <sup>1</sup>
U.S. Route 29 at Maryland 32	1984, 1985 <sup>2</sup>
U.S. Route 29 at Owen Brown Road	1983, 1984, 1985 <sup>1</sup>
U.S. Route 29 at Maryland 108	1983, 1984, 1985 <sup>3</sup>
U.S. Route 29 at Spur to Maryland Route 103	1983, 1984, 1985 <sup>1</sup>

- 1 - Interchange Proposed
- 2 - Interchange Constructed
- 3 - Interchange Under Construction

SECTION III

At the Alternates Public Workshop held February 8, 1986, at the Hammond High School, three alternates were presented for each segment within this project (Figure 2). The alternates were:

Alternate A -- No Build Alternate consisting of the maintenance of the existing highway design.

Alternate B -- Roadway widening within the median and no access control.

Alternate C -- Roadway widening within the median with access control.

Alternates A and B were presented for each segment. In addition, numerous concepts were developed under Alternate C in each segment. A total of 22 Alternate C concepts were presented at the workshop.

A. ALTERNATES NO LONGER BEING CONSIDERED

Six of the Alternate C concepts were dropped from further consideration. The concepts and the reasons they were deleted from further study are presented below:

At Rivers Edge Road (Segment VII)  
VII-C-1: Right-on; Right-off Only)

Rivers Edge Road would have remained intact with the exception of the median crossover. This would have allowed only the right-on, right-off movements from U.S. Route 29. Crossover movements would have been achieved at adjacent interchanges.

This concept was dropped after the Alternates Public Workshop because the concept included a right-on, right-off movement at Old Columbia Road on the east side of U.S. Route 29. The acceleration lane for the right-on movement would have extended onto the bridge over the Middle Patuxent River. The required widening of the bridge was not considered to be cost effective.

VII-C-2: Underpass

Rivers Edge Road would have been reconstructed as an underpass to U.S. Route 29, connecting with Old Columbia Road on the east side of U.S. Route 29. Access ramps to and from the southbound U.S. Route 29 would have served Rivers Edge Road. Northbound U.S. Route 29 would have had access to ramps along Old Columbia Road. The ramp configuration was a weaving lane connecting a tight on ramp with a tight off ramp. All existing access points and median crossovers to U.S. Route 29 would have been severed along this segment.

This concept was dropped after the Alternates Public Workshop because the weaving lane was carried on the bridge over the Middle Patuxent River. As with Concept VII-C-1, the required bridge widening was not considered to be cost effective.

101

At Seneca Drive (Segment VIII)

VIII-C-1: Right-on, Right-off Only

Seneca Drive would have remained intact with access to and from northbound U.S. Route 29. The median crossover would have been eliminated and all crossover movements would have been achieved at adjacent interchanges.

This concept was dropped after the Alternates Public Workshop because no access was provided for the developing properties on the west side of U.S. Route 29.

VIII-C-2: Overpass

This concept would close Seneca Drive to U.S. Route 29 as it exists today and constructing a structure over U.S. Route 29 utilizing the Seneca Drive alignment and grade. This would have allowed access for traffic westbound. Seneca Drive to southbound U.S. Route 29 traffic heading north on U.S. Route 29 could have made the eastbound movement onto Seneca Drive via a proposed ramp.

All crossover movements would have been made at adjacent interchanges. A service road would have been built to provide access to the parcels in the northeast quadrant of the Seneca Drive/U.S. Route 29 intersection.

This concept was dropped after the Alternates Public Workshop because no access was provided for the developing properties on the west side of U.S. Route 29, and the Seneca Drive to northbound U.S. Route 29 movement was not provided.

At Pepple Drive and Diamondback Drive (Segment IX)

IX-C-2: No Access at Pepple or Diamondback

This concept proposed closing all access points to U.S. Route 29 at Pepple Road and Diamondback Drive. All crossover movements would have been made at adjacent interchanges.

This concept was dropped after the Alternates Public Workshop because it was felt that the ramp at Maryland Route 175 should be improved (see Concept IX-C-3).

At Spring Valley Road (Segment X)

X-C-1: Right-on Only

This concept would close the median crossover to U.S. Route 29 allowing only a right-on movement. Crossover traffic would use the proposed Maryland Route 103 interchange.

This concept was dropped after the Alternates Public Workshop because the movement is considered part of the proposed Maryland Route 103 interchange.

**B. ALTERNATES CONSIDERED**

Alternate A

Alternate A is the No Build option consisting of the maintenance of the existing highway design. All existing at-grade intersections would remain

except those planned for future development. Key points of the No Build Alternate are:

1. The capacity of U.S. Route 29 would not be increased.
2. Existing traffic conditions and congestion would worsen as demand and traffic volumes increase.
3. No additional right-of-way would be required.
4. Motorist safety would remain a problem.
5. Costs associated with this Alternate are limited to those incurred for the normal activities for roadway maintenance.
6. Inconsistent with Howard County General Plan.

In addition to the No Build Alternate, the Build Alternates, Alternates B and C were considered in each segment. Two Alternate C concepts in Segment VI and one in Segment IX were modified since the Alternates Public Workshop; one new Alternate C concept was developed in Segments VI, VII and VIII following the workshop. Two modifications to the new Alternate Concept in Segment VII were also developed. Alternates B and C are described below:

#### Alternate B

Alternate B is roadway-widening within the median with no control of access, consisting of widening the corridor from 4 to 6 lanes and leaving all existing at-grade intersections and other access points intact except those planned for future development. Mapping for this alternate is represented as widening only on the Detailed Alternates Mapping. Key points of Alternate B include:

1. The mainline capacity of U.S. Route 29 would be increased by widening from 4 to 6 lanes within the median.
2. No additional right-of-way would be required.
3. Lack of controlled access does little to improve motorist safety.
4. Estimated cost by Segment is:
 

VI-B	2.490 million
VII-B	2.103 million
VIII-B	2.137 million
IX-B	2.430 million
X-B	0.384 million
XI-B	No Cost
5. Inconsistent with Howard County General Plan.

#### Alternate C

Alternate C is roadway-widening within the median, with control of access consisting of acquiring access control by constructing grade separations and/or service roads. All median crossovers and traffic signals would be removed. Several interchange concepts have been developed as a part of this alternate, as described below for each Segment. Detailed Alternates Mapping is presented at the end of this section. All references to right-of-way required and to costs are additional over that required for the roadway widening (Alternate B).

Segment VI -- Alternate C concepts are being considered at three interchange areas -- Old Columbia Road and Hammond and Hillcrest Drive, and Hopkins/Gorman Road.

At Old Columbia Road:  
(See Detailed Alternates Mapping, Sheet 1 of 8)

VI-C-1: Right-on, Right-off

Old Columbia Road would remain intact, with the exception that the median crossover to U.S. Route 29 would be removed allowing only right-on, right-off movements both northbound and southbound. Key points are:

- 1. Required right-of-way would be 0.09 acres
- 2. Existing access would remain and crossover traffic would use adjacent interchanges.
- 3. Estimated cost is \$492,000

VI-C-2: Overpass

Old Columbia Road would be relocated approximately 100' to the south, thus allowing the proper grades for the proposed overpass. All access points to U.S. Route 29 from existing Old Columbia Road would be removed and access to U.S. Route 29 would be achieved at the Md. Route 216 interchange. Service Road 'A' would be constructed. Key points are:

- 1. Required right-of-way would be 6.88 acres.
- 2. Capacity and safety along U.S. Route 29 would be increased by removing the Old Columbia Road intersection.
- 3. All turning movements onto U.S. Route 29 would be via Maryland Route 216 interchange.
- 4. Estimated cost is \$1.731 million.

VI-C-3: Extending Service Road 'A'

All access to U.S. Route 29 at Old Columbia Road would be removed. Service Road 'A' would be extended to Harding Road and all access to U.S. Route 29 would be via Maryland Route 216 interchange. This alignment of the extension of Service Road "A" was changed from the alignment shown at the Alternates Public Workshop to avoid impacting one residence. Key points are:

- 1. Required right-of-way would be 7.63 acres.
- 2. Capacity and safety along U.S. Route 29 would be increased by removing the Old Columbia Road intersection.
- 3. Local circulation would be enhanced.
- 4. Estimated cost is \$1.087 million.

VI-C-4: Extending Cherry Lane to Harding Road

Alternate VI-C-4 was developed after the Alternates Public Workshop to take into consideration access for the new Cherry Tree Farms development. Approximately 200 feet of roadway would be constructed to extend Cherry Tree Lane to Harding Road. This concept could be implemented in association with Alternates VI-C-1 or VI-C-2, or could be implemented separately.

1. Required right-of-way would be 0.275 acres.
2. Local traffic circulation would be enhanced.
3. Estimated cost is \$28,000.

At Hammond Drive and Hillcrest Drive:  
 (See Detailed Alternates Mapping, Sheet 2 of 8)  
VI-C-1: Right-on, Right-off

The intersection at Hillcrest Drive would be closed. Hammond Drive would remain intact allowing right-on and right-off movements to U.S. Route 29. In Concept VI-C-1 presented at the Alternates Public Workshop, the median crossover and intersection at Hammond Drive were proposed to be closed and the right-on, right-off movements were proposed to take place at Hillcrest Drive. The revision provides a greater distance between the entrance ramp from Maryland Route 216 onto northbound U.S. Route 29 and the right-on, right-off movement. Key points are:

1. Required right-of-way would be 0.40 acres.
2. Crossover traffic would use adjacent interchange.
3. Estimated cost is \$288,000

VI-C-2: Extending Hammond Parkway

All access to U.S. Route 29 would be severed at Hillcrest Drive and Hammond Drive. Hammond Parkway would be extended to connect with Hammond Drive to accommodate all traffic to U.S. Route 29 via the proposed Hopkins/Gorman Road interchange. Key points are:

1. Required right-of-way would be 1.08 acres.
2. Capacity and safety along U.S. Route 29 would be increased.
3. Local circulation would be enhanced.
4. Estimated cost is \$425,000

VI-C-3: Extending Crest Road to Hammond Hills

All access to U.S. Route 29 at Hillcrest Drive and Hammond Drive would be severed. A proposed extension of Crest Road to the Hammond Hills development would divert all U.S. Route 29 bound traffic to Maryland Route 216. Key points are:

1. Required right-of-way would be 1.62 acres.
2. Capacity and safety along U.S. Route 29 would be increased.
3. Local circulation would be enhanced.
4. Possible traffic impact on Hammond Hills development.
5. Estimated cost is \$95,000



At Hopkins/Gorman Road:  
(See Detailed Alternates Mapping, Sheet 2 of 8)  
VI-C-1: Overpass

Alternate VI-C-1 was developed since the Alternates Public Workshop and after detailed environmental analysis. The existing signalized intersection at Johns Hopkins/Gorman Road and U.S. Route 29 would be closed. An overpass would be constructed approximately 200 feet north of the existing intersection. Diamond type ramps would be provided for the southbound movements. A loop ramp and an outer ramp would be provided for the northbound movements. The relocated Hopkins/Gorman Road would tie into the existing roadway approximately 1400 feet west of U.S. Route 29. The new roadway would form a T-intersection with the existing roadway approximately 300 feet east of the existing intersection of Hammond Parkway at Gorman Road. An access road would be provided from Gorman Road to Old Columbia Road near the Middle Patuxent River. Key points are:

1. Required right-of-way would be 5.484 acres.
2. Full access is provided to all properties on both sides of U.S. Route 29.
3. Capacity and safety on U.S. Route 29 is increased.
4. Estimated cost is \$6.512 million.

Segment VII -- Alternate C concepts are being considered at one location in Segment VII--at Rivers Edge Road. (See Detailed Alternates Mapping, Sheet 3 of 8.)

VII-C-3: Underpass

This alternate is similar to Concept VII-C-2 which was dropped after the Alternates Public Workshop (See Section III.A.) in all aspects except that the location of the northbound ramps between U.S. Route 29 and Old Columbia Road would be changed. The ramps would not be located on the bridge over the Middle Patuxent River and a higher design speed on the ramps would be provided. Key points of this alternate are:

1. Required right-of-way would be 2.94 acres.
2. Full access would be provided to Rivers Edge Road and Old Columbia Road.
3. Extensive earthwork would be required for the proposed ramps to Old Columbia Road.
4. Estimated cost is \$2.179 million.

VII-C-4: Underpass

Concept VII-C-4 is a concept developed since the Alternates Public Workshop. This alternate is similar to Concept VII-C-3 in all aspects except that the location of the southbound ramps between U.S. Route 29 and Rivers Edge Road would be changed. Instead of tying in at the existing Rivers Edge Road/Longview Road intersections as in Concept VII-C-3, a new intersection would be formed on Rivers Edge Road between U.S. Route 29 and Longview Road. Key points are:

1. Required right-of-way would be 3.51 acres.
2. Full access would be provided to Rivers Edge Road and more direct access would be provided to Old Columbia Road traffic headed southbound on U.S. Route 29.
3. Extensive earthwork would be required for the proposed ramps to Old Columbia Road.
4. Estimated cost is \$2.373 million.

Segment VIII -- Alternate C concepts are being considered at two locations in Segment VIII--at Seneca Drive and at Gales Lane.

At Seneca Drive:

(See Detailed Alternates Mapping, Sheet 4 of 8.)

VIII-C-3: Overpass, Partial Diamond

This concept would close Seneca Drive as it exists today and construct a structure over U.S. Route 29 utilizing the Seneca Drive alignment and grades. A diamond ramp for access to and from southbound U.S. Route 29 from the overpass would be provided. Ramps to and from northbound U.S. Route 29 are also provided.

Extended Seneca Drive would extend west to Martin Road at Windsor Court. This would provide more direct access to U.S. Route 29 for Clemens Crossing. A service road would be provided to connect Allview Drive with Seneca Drive to provide access to the parcels in the northeast quadrant of the Seneca Drive/U.S. Route 29 intersection.

The alignment of Seneca Drive Extended was revised slightly from the alignment shown at the Alternates Public Workshop. The revision was made to minimize the impacts.

The southbound entrance ramp was relocated to provide access to traffic from the east side of U.S. Route 29. Key points of this alternate are:

1. Capacity and safety along U.S. Route 29 would be increased.
2. Required right-of-way would be 4.08 acres.
3. Full access would be provided to developments and properties on both sides of U.S. Route 29.
4. Local circulation would be improved with the connection to Martin Road.
5. Estimated cost is \$4.960 million.

VIII-C-4: Relocation of Seneca Drive-Overpass

This concept would relocate Seneca Drive approximately 500 feet to the south of its present location. This relocation would allow the proper grades and alignment for the proposed overpass. This Seneca Drive overpass would allow the southbound U.S. Route 29 movements to occur via diamond ramps. Along with this partial diamond, the proposed Seneca Drive overpass would make a direct connection to Martin Road at Windsor Court.

This concept would leave the existing Seneca Drive open for right-on, right-off movements only, and would provide a service road for the parcels located in the northeast quadrant of Seneca Drive and U.S. Route 29.

As with Concept VIII-C-3, the alignment of Seneca Drive Extended was revised slightly from the alignment shown at the Alternates Public Workshop in order to minimize the impacts to Dike Property. Key points for this alternate are:

- 1. Required right-of-way would be 3.26 acres.
- 2. Capacity and safety along U.S. Route 29 would be increased.
- 3. Full access would be provided to developments and properties on both sides of U.S. Route 29.
- 4. Local circulation would be improved with the connection to Martin Road.
- 5. Disruption of the existing traffic movement during construction would be minimized by the relocation of Seneca Drive.
- 6. Estimated cost is \$5.182 million.

VIII-C-5: Relocation of Seneca Drive-Overpass

Concept VIII-C-5 is a concept developed since the Alternates Public Workshop. This alternate would relocate Seneca Drive approximately 350 feet to the south of its present location. This location would allow the proper grades and alignment for the proposed overpass. This Seneca Drive overpass would allow the southbound U.S. Route 29 movements to occur via diamond ramps. Along with this partial diamond, the proposed Seneca Drive Extension would make a direct connection to Martin Road at Windsor Court. As described, this alternate would be similar to Concept VIII-C-4 on the west side of U.S. Route 29. The differences are on the east side of the mainline.

The northbound right-on, right-off movements would take place approximately 50 feet north of the existing Seneca Drive. Old Columbia Road on the west side of Seneca Drive would form an at-grade intersection with Relocated Seneca Drive and the extension of the Service Road from Allview Drive. Key points are:

- 1. Required right-of-way would be 6.06 acres.
- 2. Capacity and safety along U.S. Route 29 would be increased.
- 3. Full access would be provided to developments and properties on both sides of U.S. Route 29.
- 4. Local circulation would be improved with the connection to Martin Road.
- 5. Estimated cost is \$3.687 million.

VIII-C-5A: Relocation of Seneca Drive Overpass-Modification A

Concept VIII-C-5A was developed as a modification to Alternate VIII-C-5 to improve the radius of the curve on Relocated

Seneca Drive from the overpass to the connection to existing Seneca Drive. The 575 foot radius curve has a design speed of 40 miles per hour (mph) which is an improvement to the 20 mph design speed of the 100 foot radius curve in Alternate VIII-C-5. An additional residence would be displaced as part of this alternate.

All other aspects of this alternate are the same as Alternate VIII-C-5. Key points of this alternate are:

1. Required right-of-way would be 6.34 acres.
2. Capacity and safety along U.S. Route 29 would be increased.
3. Safety on Seneca Drive would be improved.
4. Full access would be provided to developments and properties on both sides of U.S. Route 29.
5. Local circulation would be improved with the connection to Martin Road.
6. Estimated cost is \$3.884 million.

VIII-C-5B: Relocation of Seneca Drive Overpass-Modification B

Concept VIII-C-5B was developed as a modification to Alternate VIII-C-5 to improve the radius of the curve on Relocated Seneca Drive from the overpass to the connection to existing Seneca Drive without requiring an additional residence displacement. A 30 mph curve in Alternate VIII-C-5B is an improvement to the 20 mph radius curve included in Alternate VIII-C-5 while requiring only slightly more right of way.

All other aspects of this alternate are the same as Alternate VIII-C-5. Key points are:

1. Required right-of-way would be 6.07 acres.
2. Capacity and safety along U.S. Route 29 would be increased.
3. Safety on Seneca Drive would be improved.
4. Full access would be provided to developments and properties on both sides of U.S. Route 29.
5. Local circulation would be improved with the connection to Martin Road.
6. Estimated cost is \$3.708 million.

At Gales Lane:  
(See Detailed Alternates Mapping, Sheet 5 of 8.)  
VIII-C-1: Right-on, Right-off

Gales Lane would remain open as it is today, with the right-on, right-off traffic movements only. Key points are:

1. No additional right-of-way required.
2. Crossover traffic would use adjacent interchanges.
3. Estimated cost is \$246,000

VIII-C-2: Service Road Connection

Gales Lane access to U.S. Route 29 would be severed. Access would be provided by extending Gales Lane south to Gales Lane in the River Meadows Subdivision. Key points are:

- 1. Required right-of-way would be 0.89 acres.
- 2. Local circulation would be improved.
- 3. Estimated cost is \$286,000.

Segment IX -- Alternate C concepts are being considered at two locations--at Old Columbia Road and at Pepple Road and Diamondback Drive.

At Old Columbia Road:

(See Detailed Alternates Mapping, Sheet 6 of 8.)

IX-C-1: Right-on, Right-off

Right-on, right-off traffic movement between northbound U.S. Route 29 and Old Columbia Road would be maintained. The median crossover would be closed. Key points are:

- 1. No additional right-of-way would be required.
- 2. Crossover traffic would use adjacent interchanges.
- 3. Estimated cost is \$125,000.

IX-C-2: Driveway to Twin Knolls Road

All access from Old Columbia Road onto U.S. Route 29 would be severed. To maintain access, a driveway that extends from Old Columbia Road to Twin Knolls Road would be constructed. This proposed driveway would allow the properties affected by the access control to gain access to U.S. Route 29 via Maryland Route 175. Key points are:

- 1. Required right-of-way would be 0.50 acres.
- 2. Local circulation would be improved.
- 3. Estimated cost is \$327,000.

At Pepple Road and Diamondback Drive:

(See Detailed Alternates Mapping, Sheet 7 of 8.)

IX-C-1: Right-on, Right-off

Access to U.S. Route 29 at Pepple Road would be severed. Diamondback Drive would remain open for the right-on, right-off traffic movement only. The curve on the entrance ramp from westbound Maryland Route 175 to northbound U.S. Route 29 would be flattened and lengthened to improve the design speed. These ramp improvements have been added to Alternate IX-C-1 since the Alternates Public Workshop. Key points are:

- 1. No additional right-of-way would be required.
- 2. Crossover traffic would use adjacent interchanges.
- 3. Improvements would be provided to the Maryland Route 175 on-ramp in the form of a continuous weaving lane and the

- flattening of the radius.
- 4. Estimated cost is \$403,000.

IX-C-3: Improvements to Maryland Route 175 Ramp

All access points to U.S. Route 29 at Pepple Road and Diamondback Drive would be severed. The curve on the entrance ramp from westbound Maryland Route 175 to northbound U.S. Route 29 would be flattened and lengthened to improve the design speed. Key points are:

- 1. No additional right-of-way is required.
- 2. Capacity and safety of U.S. Route 29 would be improved.
- 3. Crossover traffic movements would be made at adjacent interchanges.
- 4. Improvements would be provided to the U.S. Route 175 ramp by flattening the radius.
- 5. Estimated cost is \$167,000.

Segment X -- Alternate C concepts are being considered at Spring Valley Road. (See Detailed Alternates Mapping, Sheet 7 of 8.)

X-C-2: No Access

This concept would sever all access to U.S. Route 29 at Spring Valley Road. Key points are;

- 1. No additional right-of-way would be required.
- 2. Capacity and safety of U.S. Route 29 would be increased.
- 3. Possible adverse impacts to local circulation would occur.
- 4. No additional cost over that for lane widening.

Segment XI -- This segment of the U.S. Route 29 corridor exists today as a controlled access highway. No additional improvements are proposed.

# U.S. ROUTE 29 SEGMENT VI HOWARD COUNTY LINE TO NORTH OF HOPKINS / GORMAN ROAD

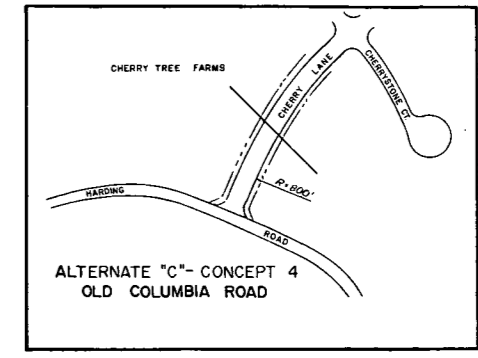
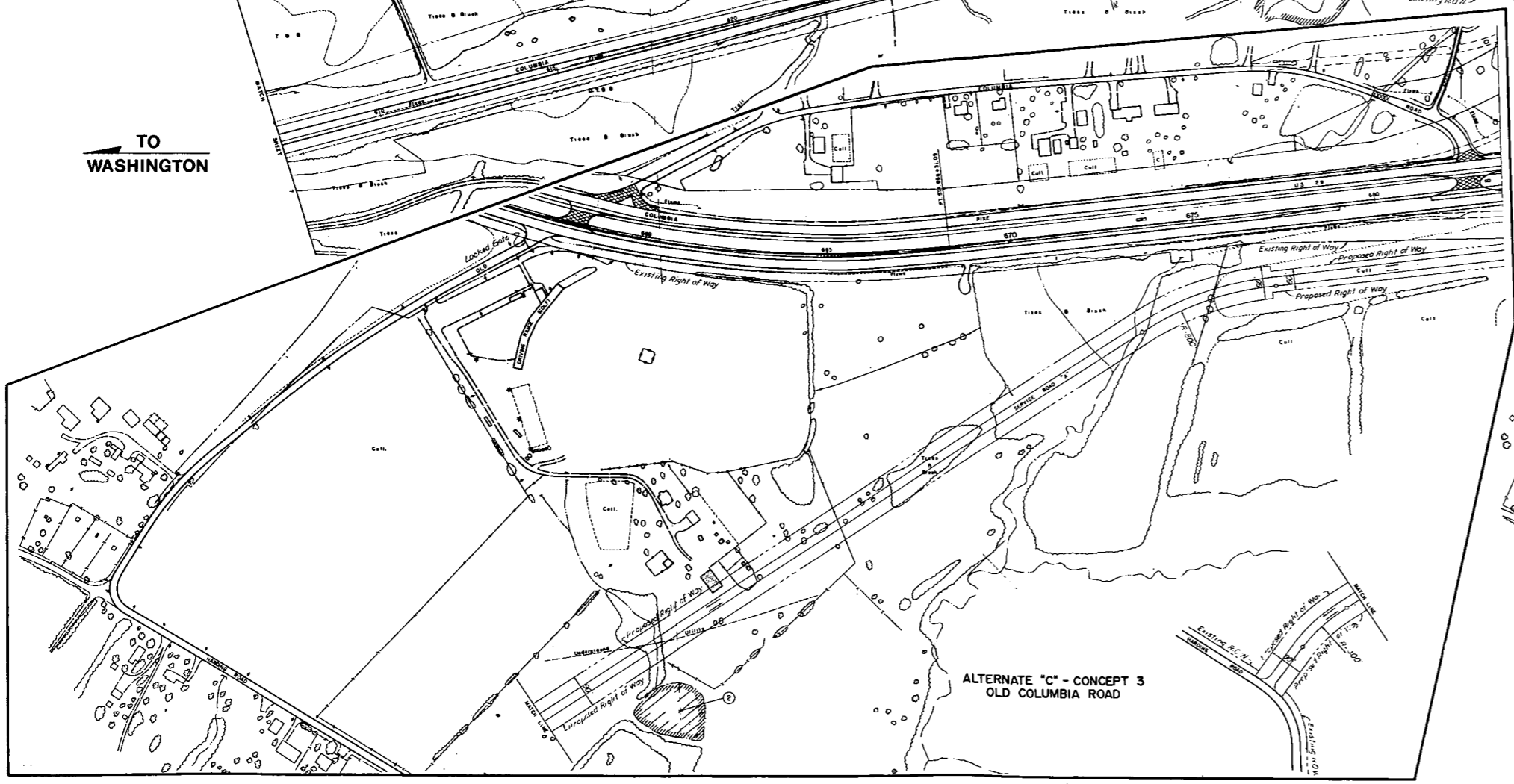
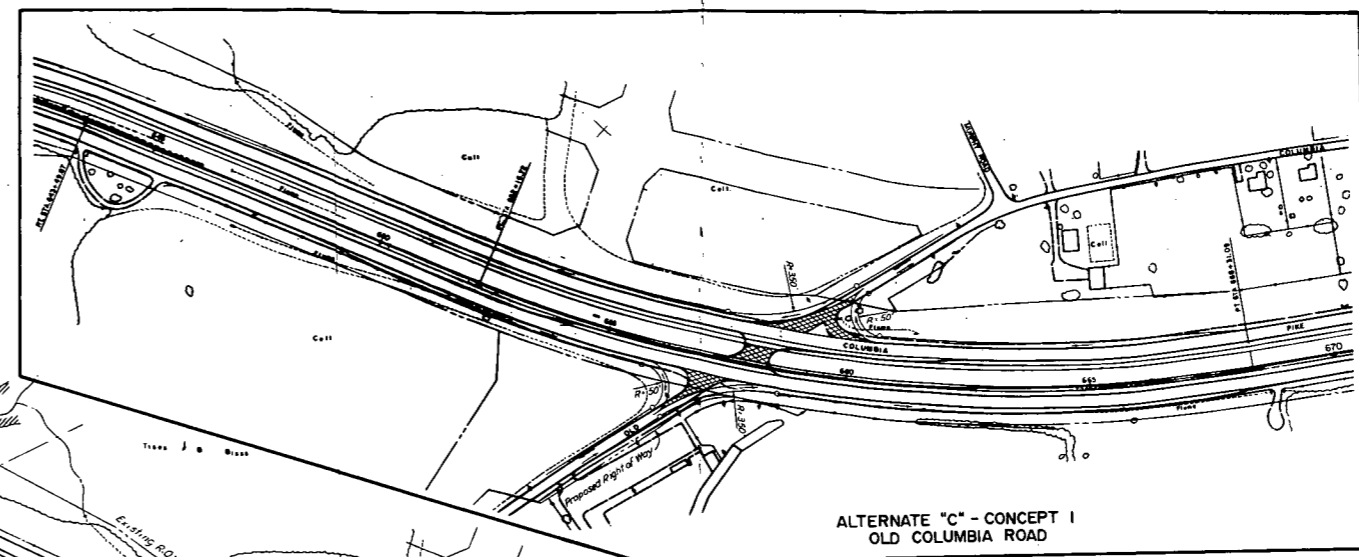
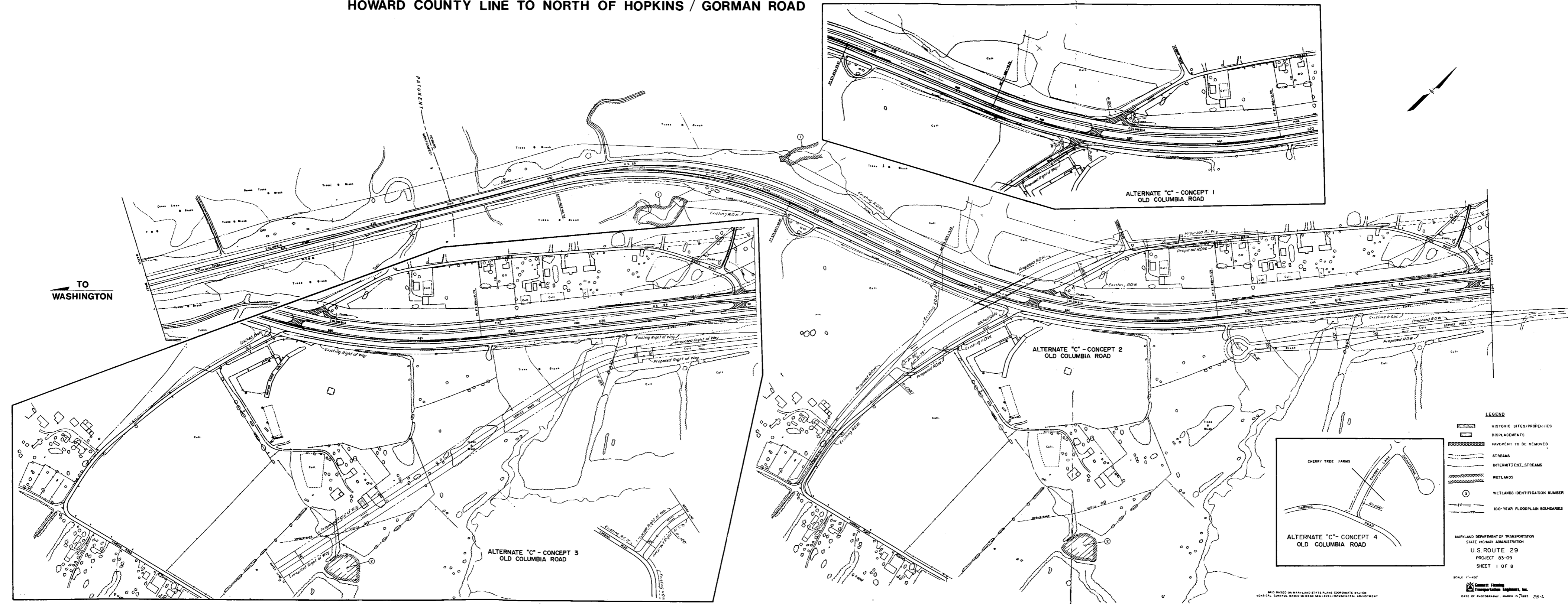

- LEGEND**
- HISTORIC SITES/PROPERTIES
  - DISPLACEMENTS
  - PAVEMENT TO BE REMOVED
  - STREAMS
  - INTERMITTENT STREAMS
  - WETLANDS
  - WETLANDS IDENTIFICATION NUMBER
  - 100-YEAR FLOODPLAIN BOUNDARIES

MARYLAND DEPARTMENT OF TRANSPORTATION  
STATE HIGHWAY ADMINISTRATION  
U.S. ROUTE 29  
PROJECT 83-09  
SHEET 1 OF 8

SCALE 1"=100'  
BASED ON MARYLAND STATE PLANE COORDINATE SYSTEM  
VERTICAL CONTROL BASED ON MEAN SEA LEVEL 1928 GENERAL ADJUSTMENT

DATE OF PHOTOGRAPHY - MARCH 15, 1983 28-L

U.S. ROUTE 29 SEGMENT VI  
HOWARD COUNTY LINE TO NORTH OF HOPKINS / GORMAN ROAD

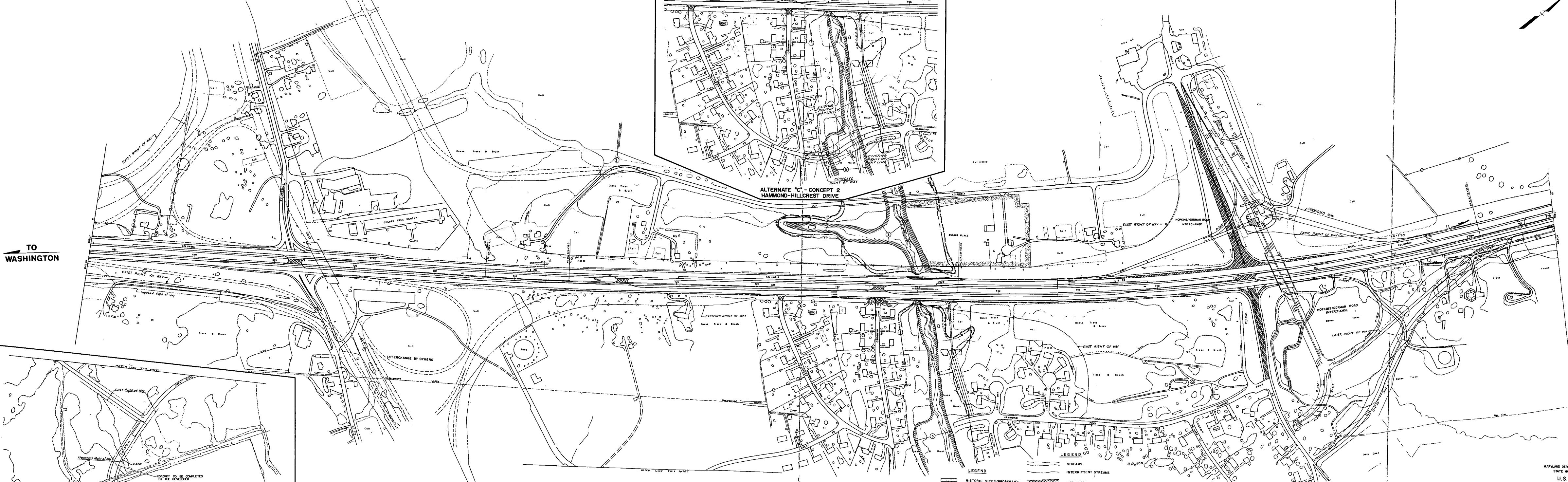

TO  
WASHINGTON

TO  
1-70

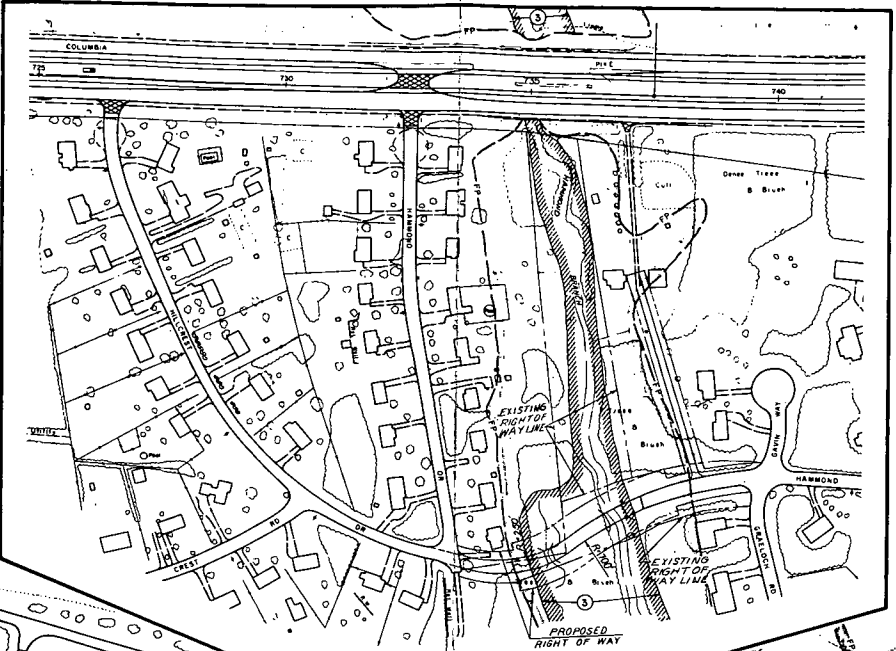
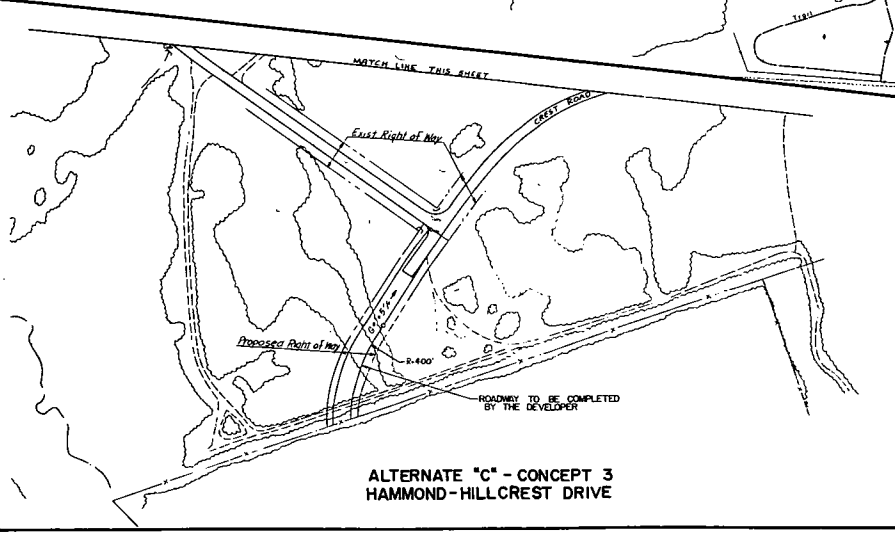

**LEGEND**

	HISTORIC SITES/PROPERTIES		STREAMS
	DISPLACEMENTS		INTERMITTENT STREAMS
	PAVEMENT TO BE REMOVED		WETLANDS
	100-YEAR FLOODPLAIN BOUNDARIES		WETLANDS IDENTIFICATION NUMBER
	100-YEAR FLOODPLAIN BOUNDARIES		100-YEAR FLOODPLAIN BOUNDARIES

ALTERNATE "C" - CONCEPT I  
HOPKINS-GORMAN ROAD  
INTERCHANGE

MARYLAND DEPARTMENT OF TRANSPORTATION  
STATE HIGHWAY ADMINISTRATION  
U.S. ROUTE 29  
PROJECT 83-09  
SHEET 2 OF 8  
SCALE: 1"=400'  
Consent Engineering, Inc.  
DATE OF PHOTOGRAPHY: MARCH 15, 1983



# U.S. ROUTE 29 SEGMENT VII NORTH OF HOPKINS / GORMAN ROAD TO NORTH OF MARYLAND ROUTE 32

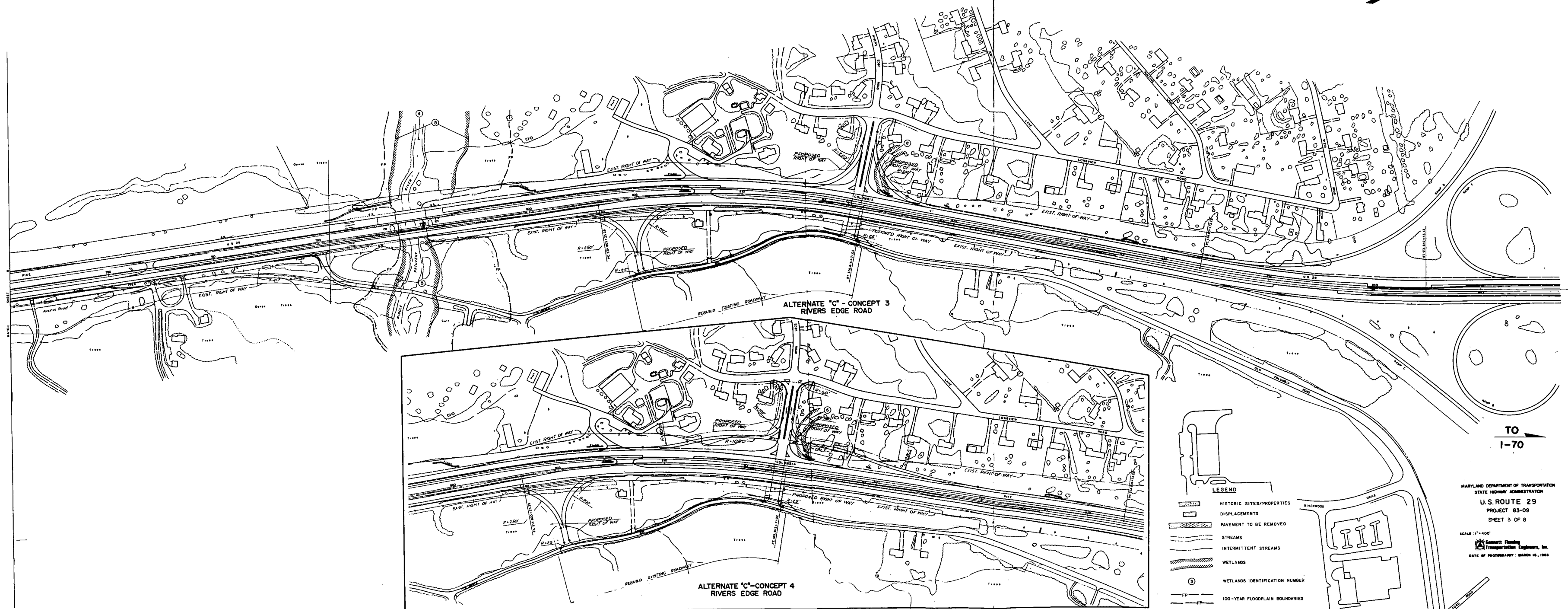

**LEGEND**

	HISTORIC SITES/PROPERTIES
	DISPLACEMENTS
	PAVEMENT TO BE REMOVED
	STREAMS
	INTERMITTENT STREAMS
	WETLANDS
	WETLANDS IDENTIFICATION NUMBER
	100-YEAR FLOODPLAIN BOUNDARIES

TO  
1-70

MARYLAND DEPARTMENT OF TRANSPORTATION  
STATE HIGHWAY ADMINISTRATION  
U.S. ROUTE 29  
PROJECT 85-09  
SHEET 3 OF 8  
SCALE: 1" = 400'  
Sennett Fleming  
Transportation Engineers, Inc.  
DATE OF PHOTOGRAPHY: MARCH 18, 1988

# U.S. ROUTE 29 SEGMENT VIII NORTH OF MD. ROUTE 32 TO SOUTH ENTRANCE TO COLUMBIA

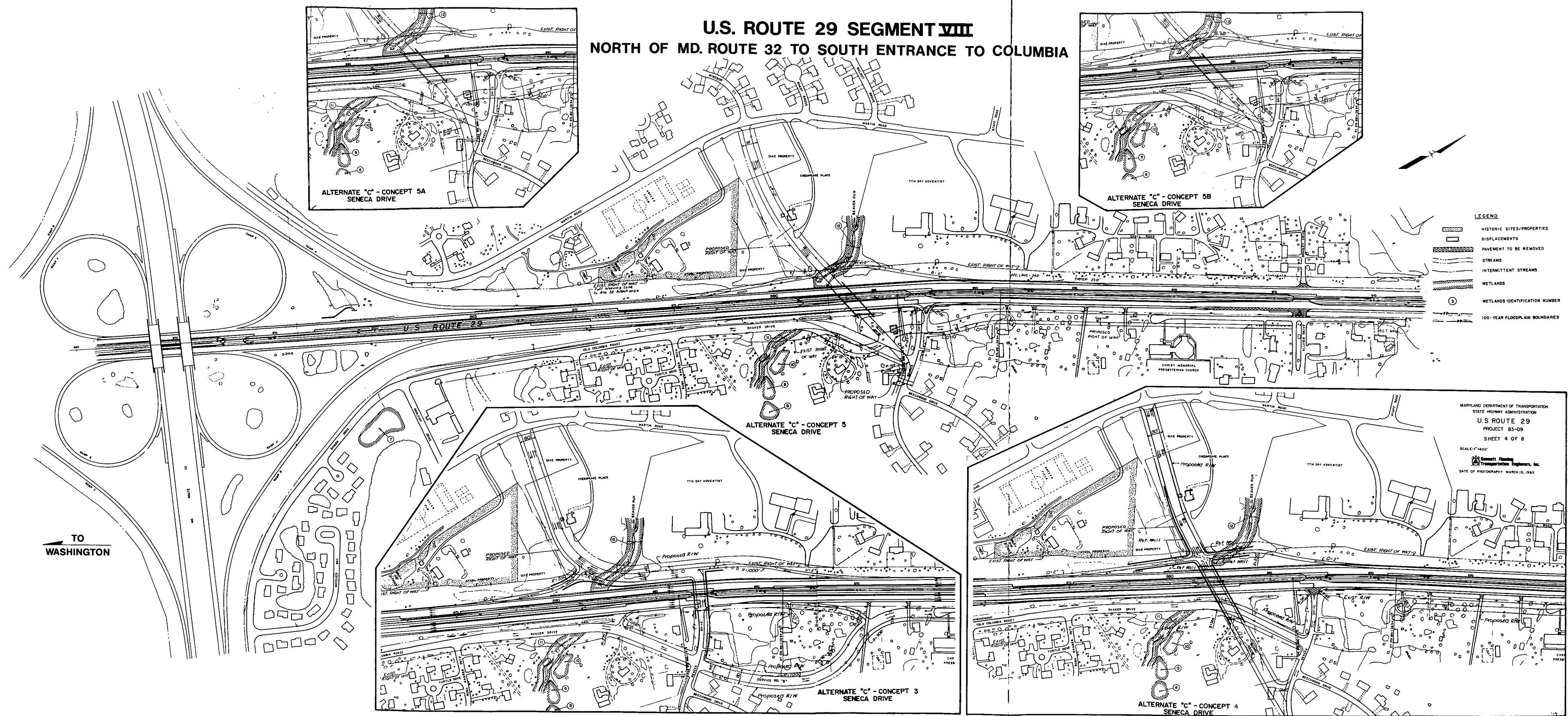

**LEGEND**

- HISTORIC SITES/PROPERTIES
- DISPLACEMENTS
- PAVEMENT TO BE REMOVED
- STREAMS
- INTERMITTENT STREAMS
- WETLANDS
- WETLANDS IDENTIFICATION NUMBER
- 100-YEAR FLOODPLAIN BOUNDARIES

MARYLAND DEPARTMENT OF TRANSPORTATION  
STATE HIGHWAY ADMINISTRATION  
**U.S. ROUTE 29**  
PROJECT 83-09  
SHEET 4 OF 8  
SCALE: 1"=400'  
Connect Planning  
Transportation Engineers, Inc.  
DATE OF PHOTOGRAPHY: MARCH 15, 1983

**U.S. ROUTE 29 SEGMENT VIII**  
**NORTH OF MD. ROUTE 32 TO SOUTH ENTRANCE TO COLUMBIA**

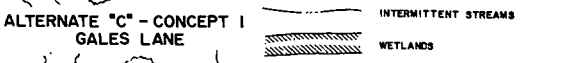
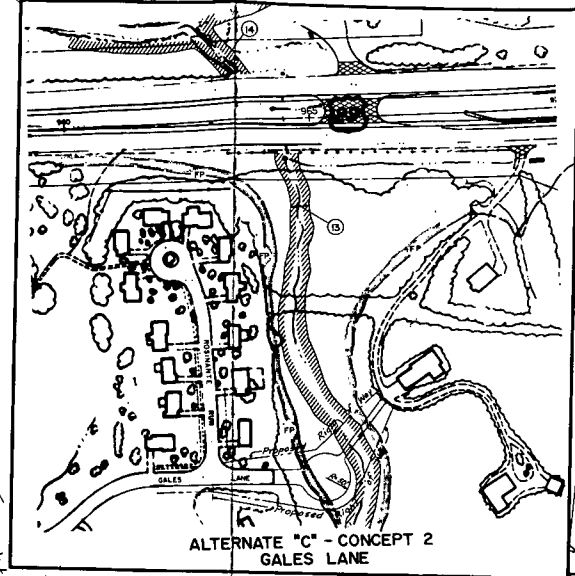
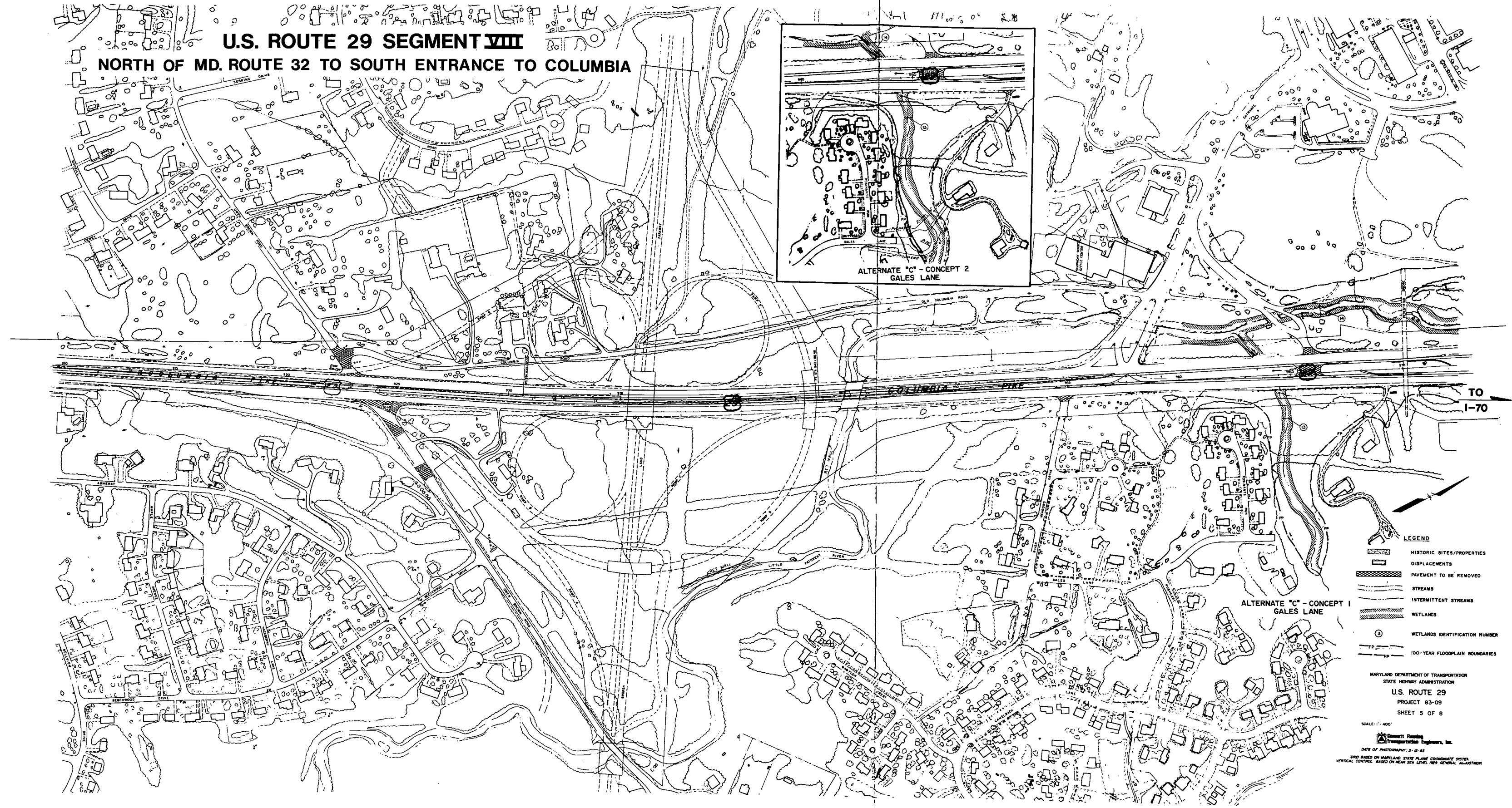

- LEGEND**
- HISTORIC SITES/PROPERTIES
  - DISPLACEMENTS
  - PAVEMENT TO BE REMOVED
  - STREAMS
  - INTERMITTENT STREAMS
  - WETLANDS
  - WETLANDS IDENTIFICATION NUMBER
  - 100-YEAR FLOODPLAIN BOUNDARIES

MARYLAND DEPARTMENT OF TRANSPORTATION  
STATE HIGHWAY ADMINISTRATION  
**U.S. ROUTE 29**  
PROJECT 83-09  
SHEET 5 OF 8

SCALE: 1" = 400'

Emmett Planning and Transportation Engineers, Inc.  
DATE OF PHOTOGRAPHY: 3-15-83  
SPR. BASED ON MARYLAND STATE PLANE COORDINATE SYSTEM  
VERTICAL CONTROL BASED ON MEAN SEA LEVEL, 1989 GENERAL ALIGNMENT

TO  
I-70

# U.S. ROUTE 29 SEGMENT IX SOUTH ENTRANCE TO COLUMBIA TO MARYLAND ROUTE 108

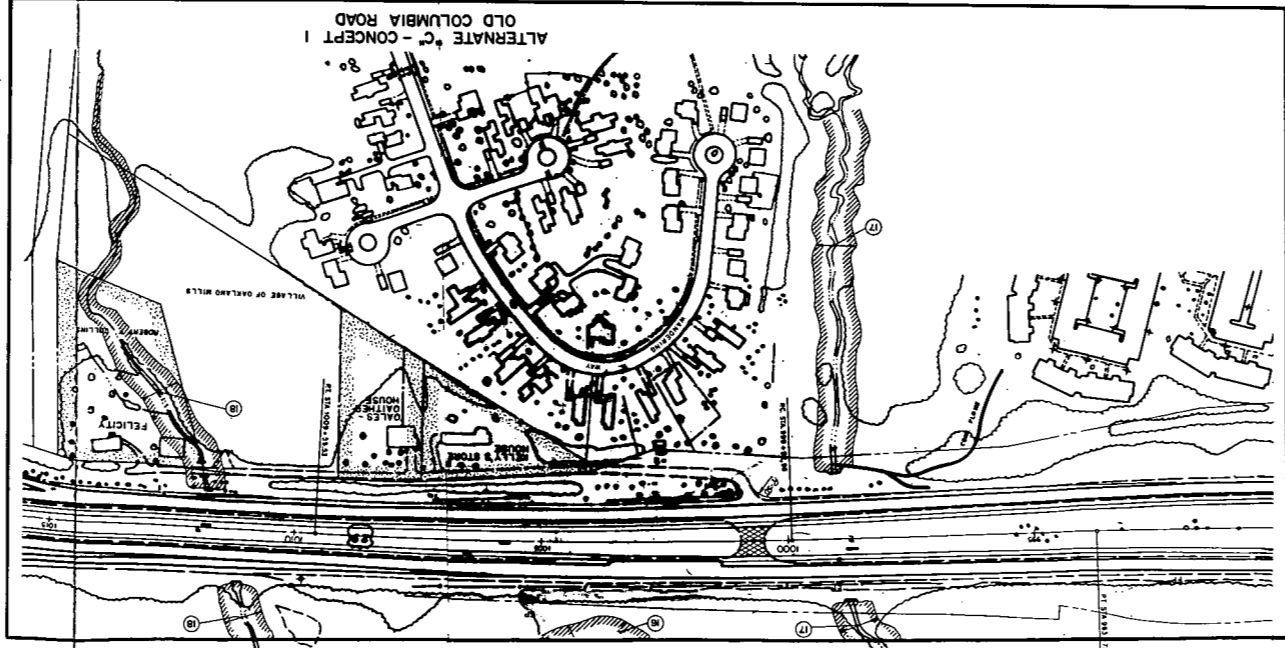

TO WASHINGTON

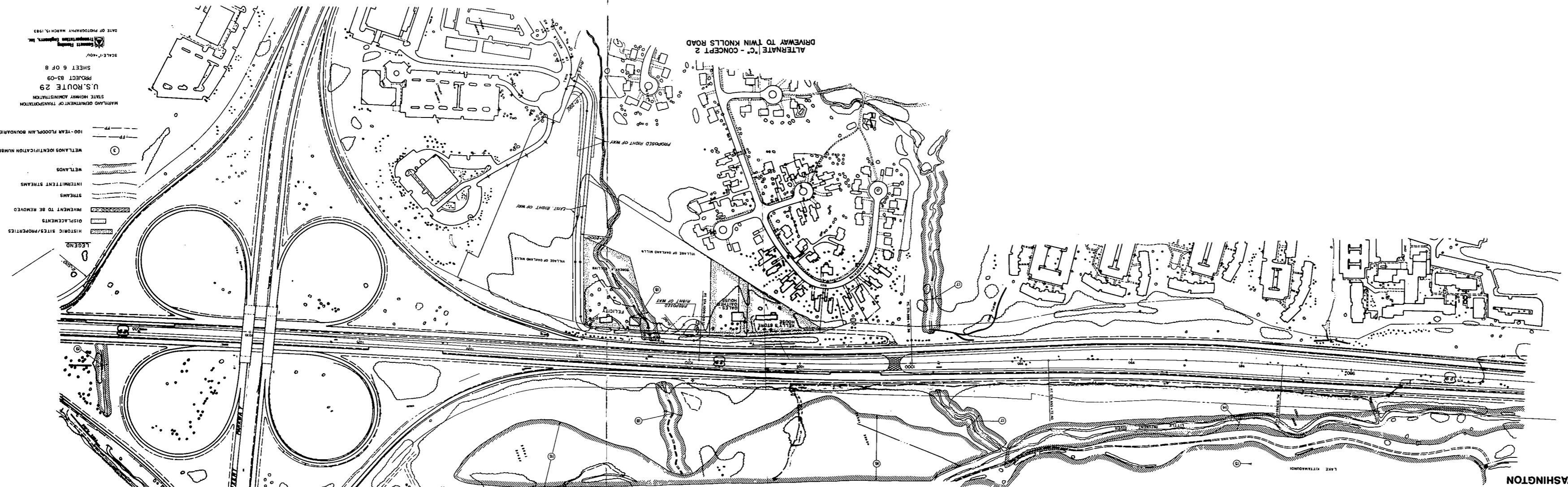

# U.S. ROUTE 29 SEGMENT X MARYLAND ROUTE 108 TO NORTH OF MARYLAND ROUTE 103

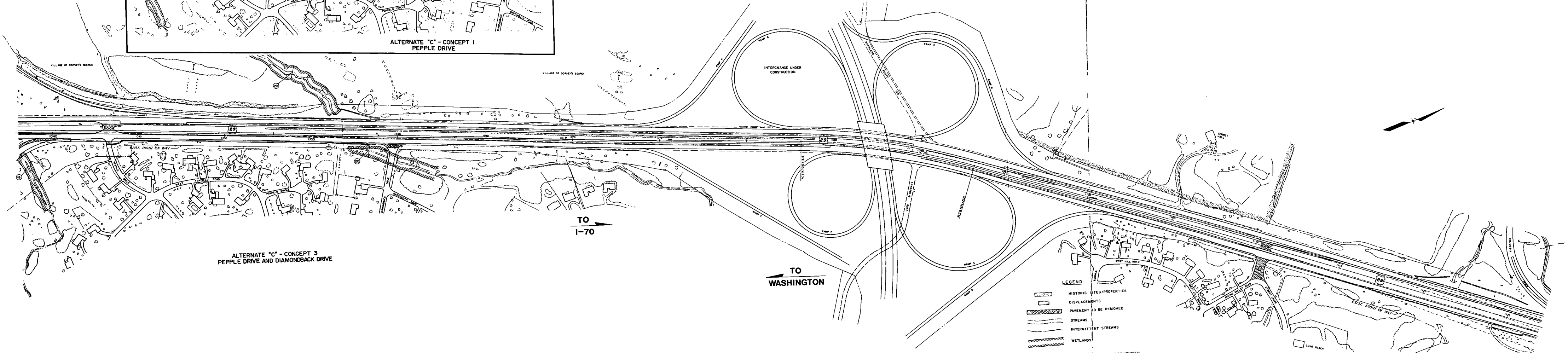
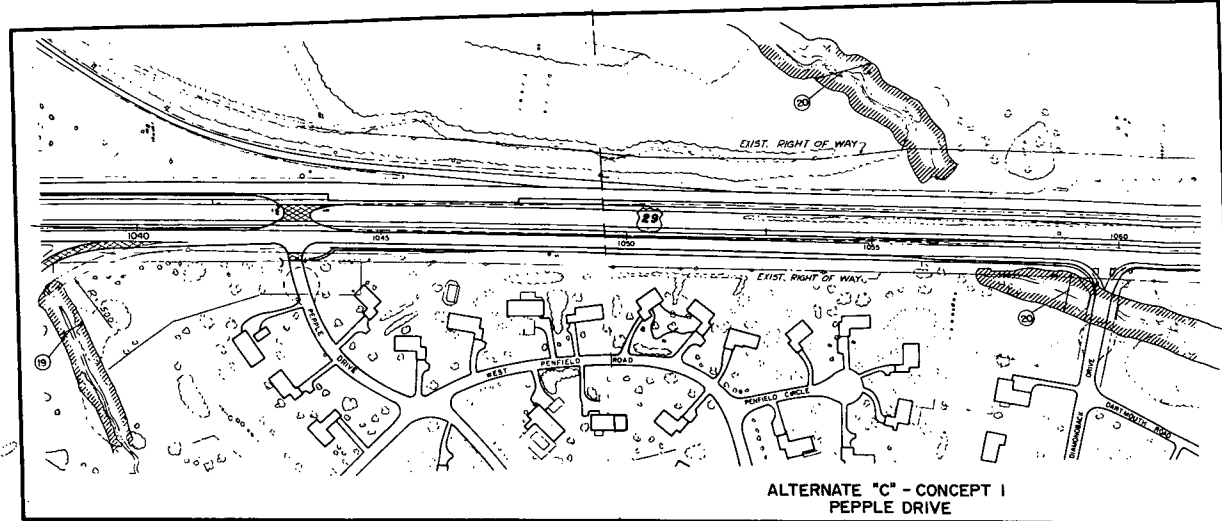

ALTERNATE "C" - CONCEPT 3  
PEPPE DRIVE AND DIAMONDBACK DRIVE

ALTERNATE "C" - CONCEPT 2  
SPRING VALLEY ROAD

- LEGEND**
- HISTORIC SITES/PROPERTIES
  - DISPLACEMENTS
  - PAVEMENT TO BE REMOVED
  - STREAMS
  - INTERMITTENT STREAMS
  - WETLANDS
  - WETLANDS IDENTIFICATION NUMBER
  - 100-YEAR FLOODPLAIN BOUNDARIES

MARYLAND DEPARTMENT OF TRANSPORTATION  
STATE HIGHWAY ADMINISTRATION  
U.S. ROUTE 29  
PROJECT 83-09  
SHEET 7 OF 8

SCALE: 1"=400'  
Commert Planning  
Transportation Engineers, Inc.  
DATE OF PHOTOGRAPHY: MARCH 15, 1983

# U.S. ROUTE 29 SEGMENT X MARYLAND ROUTE 108 TO NORTH OF MARYLAND ROUTE 103

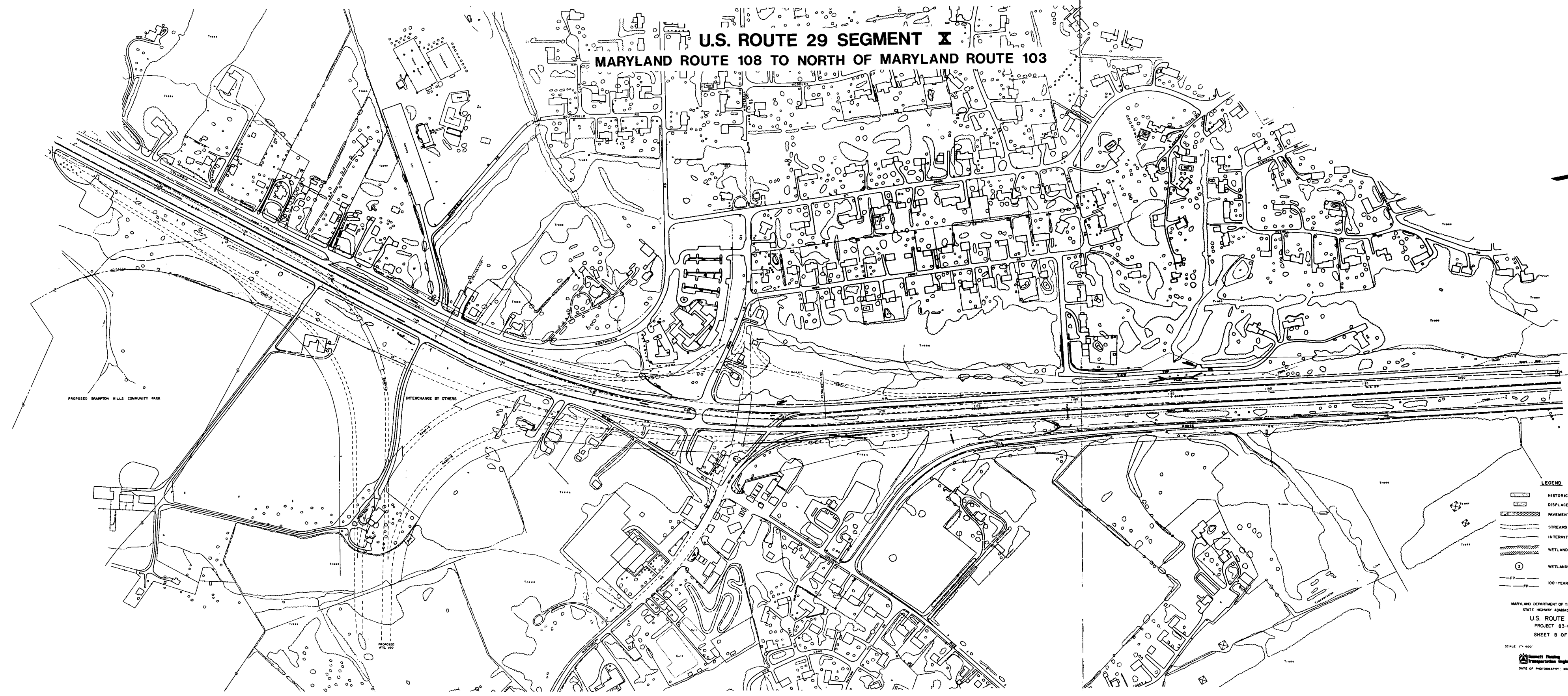

TO  
I-70

- LEGEND**
- HISTORIC SITES/PROPERTIES
  - DISPLACEMENTS
  - PAVEMENT TO BE REMOVED
  - STREAMS
  - INTERMITTENT STREAMS
  - WETLANDS
  - WETLANDS IDENTIFICATION NUMBER
  - 100-YEAR FLOODPLAIN BOUNDARIES

MARYLAND DEPARTMENT OF TRANSPORTATION  
STATE HIGHWAY ADMINISTRATION  
U.S. ROUTE 29  
PROJECT 83-09  
SHEET 8 OF 8

SCALE 1" = 400'  
  
 DATE OF PHOTOGRAPHY: MARCH 18, 1983

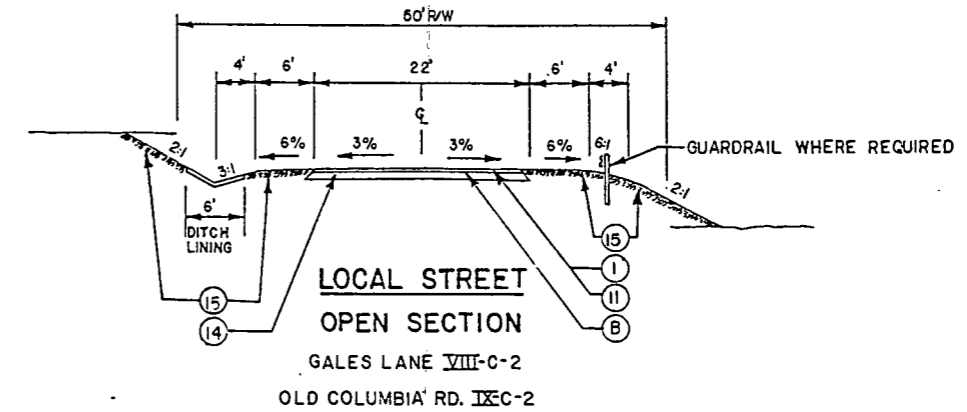
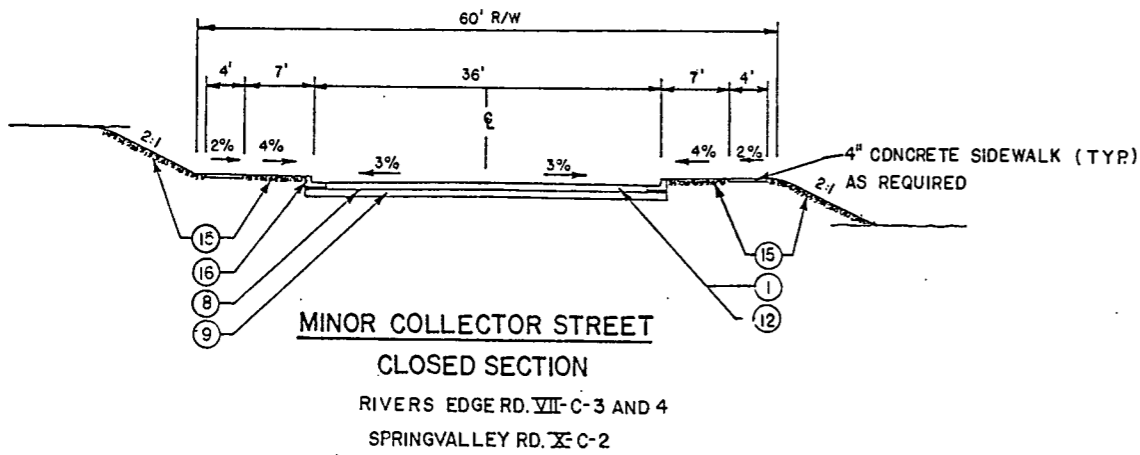
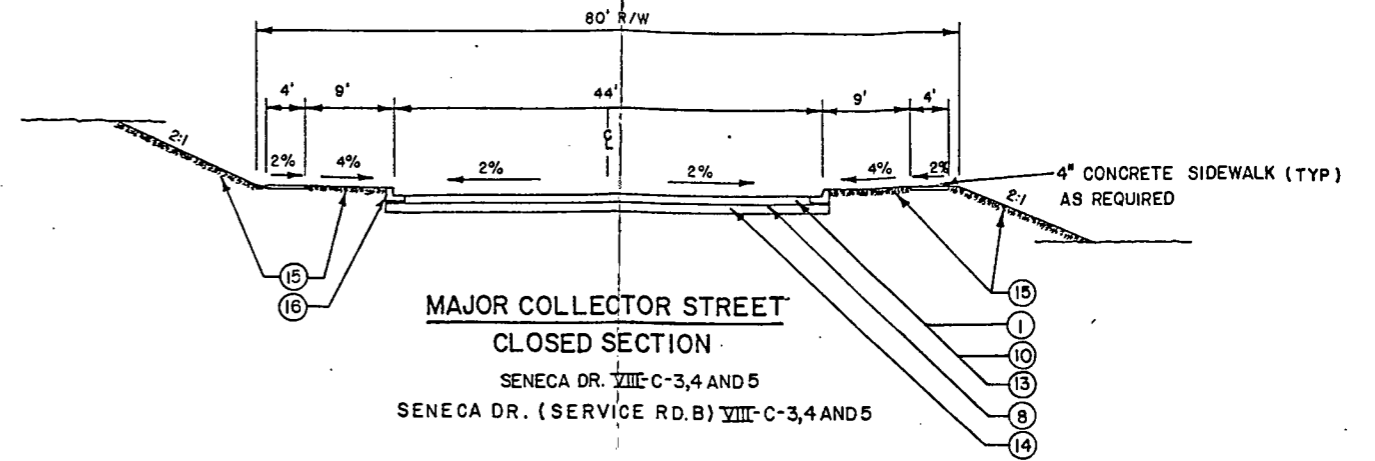
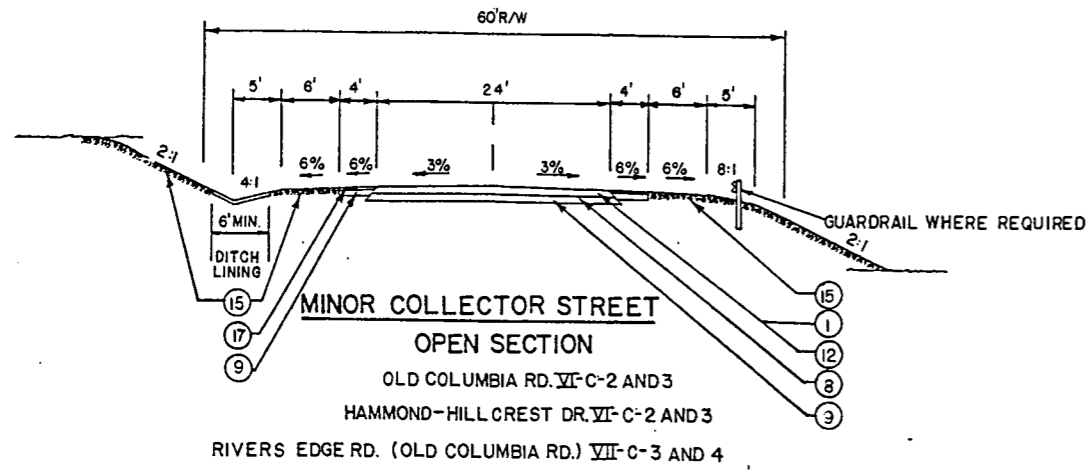

- ① 1 1/2" BITUMINOUS CONCRETE SURFACE
- ⑧ PRIME
- ⑨ 6" CRUSHER RUN BASE COURSE
- ⑩ 1 1/2" BITUMINOUS CONCRETE BASE
- ⑪ 2 1/2" BITUMINOUS CONCRETE BASE
- ⑫ 4 1/2" BITUMINOUS CONCRETE BASE

- ⑬ 5" BITUMINOUS CONCRETE BASE
- ⑭ 8" CRUSHER RUN BASE COURSE
- ⑮ SOD OR SEED AND MULCH
- ⑯ COMBINATION CONCRETE CURB AND GUTTER
- ⑰ DOUBLE BITUMINOUS SURFACE TREATMENT

**TYPICAL SECTIONS  
U.S. ROUTE 29  
HOWARD COUNTY**

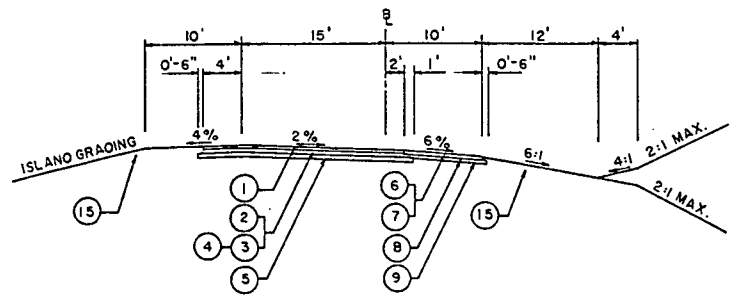

RAMPS - TANGENT SECTION

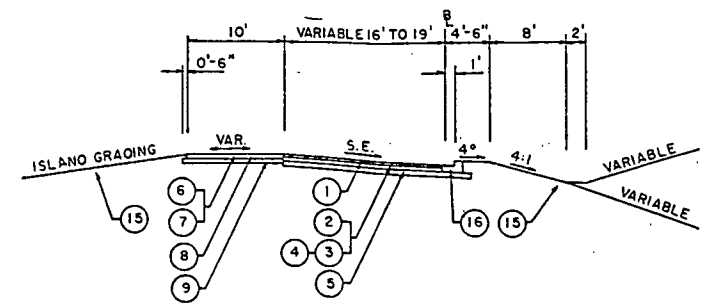

RAMPS - CURVE SECTION  
RADIUS LESS THAN 400 FT.

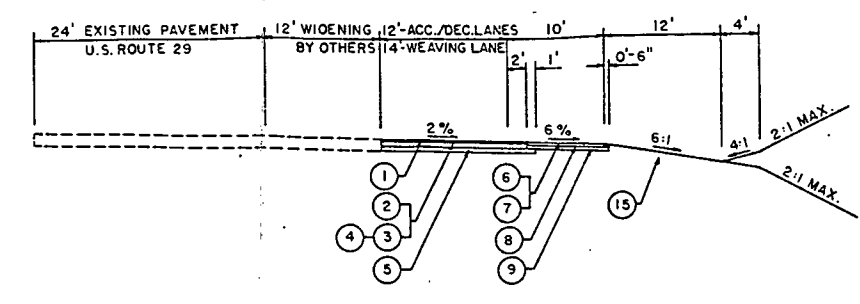

RAMP ACCELERATION & DECELERATION LANES

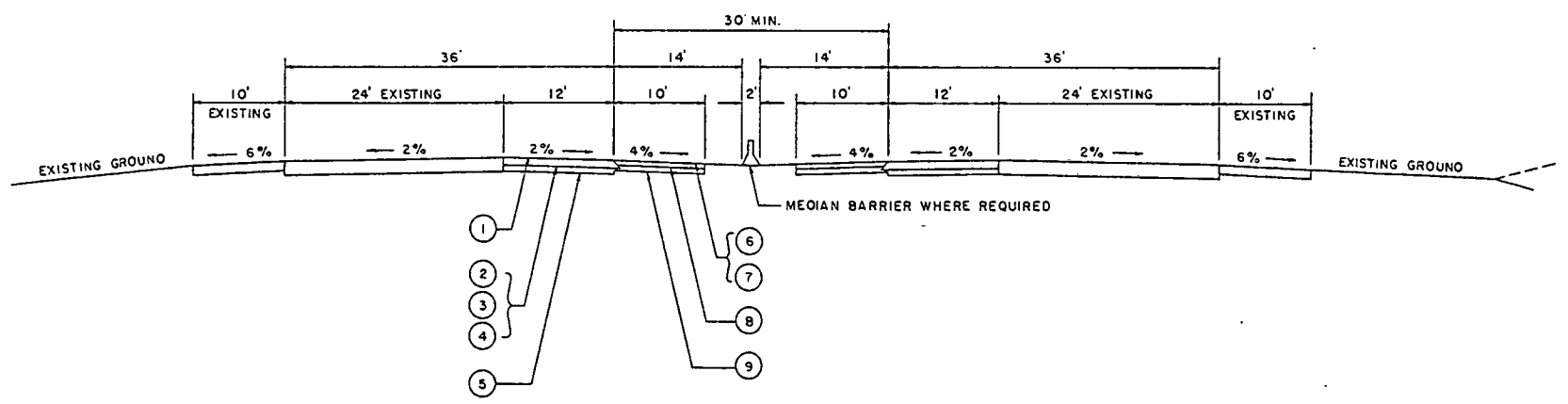

NORMAL SECTION  
6 LANE DIVIDED HIGHWAY  
INSIDE WIDENING

- ① 1 1/2" BITUMINOUS CONCRETE SURFACE - BAND SN
- ② 2" BITUMINOUS CONCRETE BASE - BAND B1
- ③ 2" BITUMINOUS CONCRETE BASE - BAND B1
- ④ 3 1/2" BITUMINOUS CONCRETE BASE - BAND BC
- ⑤ 6" SUB-BASE USING GRADE AGGREGATE SUB-BASE COURSE
- ⑥ 1 1/2" BITUMINOUS CONCRETE SURFACE - SHOULDER
- ⑦ 4 1/2" BITUMINOUS CONCRETE BASE - SHOULDER
- ⑧ PRIME
- ⑨ 6" CRUSHER RUN BASE COURSE
- ⑮ SOD OR SEED AND MULCH
- ⑯ COMBINATION CONCRETE CURB AND GUTTER

**TYPICAL SECTIONS  
U.S. ROUTE 29  
HOWARD COUNTY**



SECTION IV

A. LAND USE AND PLANNING IMPACTS

The discussion of the socioeconomic impacts of the proposed project is summarized in this assessment. The statements made in this discussion are supported by a detailed discussion provided in the U.S. Route 29 Improvement Study, Howard County, Maryland, Socioeconomic Analysis Report.

Typically, transportation systems will favorably or unfavorably impact major adjacent planned land uses depending on features such as serviceability, accessibility, and safety of the highway. Similarly, as development continues, pressure on land use will place concurrent pressure on the transportation system. A portion of the U.S. Route 29 project does not represent the typical case. Unique to the U.S. Route 29 Corridor is the location of Columbia. Columbia is a highly attractive and desirable place to live. Because of the overwhelming amenities and prestigious status of living in Columbia, the condition of the transportation system would have limited impact on the development potential within the City limits. Neighborhoods would continue to grow with the implementation of any alternate. The area outside of Columbia, on the other hand, does not have this prestigious status and would be affected substantially by the future condition of U.S. Route 29. Segment VI, Segment VII to Maryland Route 32, Segment X north of Maryland Route 108, and Segment XI are outside of the Columbia influence. Major planned land uses in these areas would be affected by the alternates.

Section I, Figure 4, depicts the future land use of currently undeveloped lands in Segments VI, VII, X, and XI. Development sites are located in:

- o Segment VI - Southeast of Maryland Route 216, a basic employment center (description in Chapter I) adjacent to
  - Hillcrest Heights, medium-density planned residential area.
  - The proposed Hopkins/Gorman Interchange, an employment center currently being developed.
- o Segment VII - Residential development expansion.
- o Segment X - Northwest of Maryland Route 108, a high-density residential and basic employment center currently under construction.
  - Adjacent to Ellicott City Armory, a basic employment center and residential development.
  - North of Maryland Route 103, land use change to environmental development.
- o Segment XI - No changes in land use.

With Alternate A, the No Build, the capacity of U.S. Route 29 would not meet projected future travel demand, resulting in increased traffic congestion and unacceptable delays. Sites adjacent to U.S. Route 29 would lose their attractiveness to developers. Therefore, the No Build Alternate would not meet land use planning objectives for the development areas.

Alternate B would somewhat increase the capacity of U.S. Route 29 through widening, but the continued presence of signalized intersections would hinder severely the overall ability of the highway to meet future travel demand. Allowing the traffic to have free access to the highway with both left and right

turns at numerous points would continue the hazardous conditions that currently exist. Alternate B would be unable to efficiently move projected traffic through the Howard County Corridor and would constrain the growth of planned residential, commercial, and industrial lands, similar to the effect of Alternate A.

Alternate C is the most consistent with land use and development planning for the corridor, because it provides the safest and most efficient response to future travel demand. By widening the highway and limiting access with all Alternate C concepts, the improved serviceability of U.S. Route 29 would increase further the desirability of the sites and would enhance development potential.

**B. DISPLACEMENTS**

Alternates A and B require no displacements or relocations of residential or business properties. Displacements for Alternate C are shown on Table 20. A maximum of seven families, totaling approximately 33 individuals, could be displaced by the worst case scenario of alternate concept selection.

Given any Alternate C concept, no minorities, elderly, or handicapped persons would be affected. The economic status of four families is middle income, and the remaining two are low income. No nonprofit organizations would be affected. The Multi-List-Service revealed that comparable, affordable replacement housing is available for persons displaced by the alternates.

The two commercial structures which would be replaced by the Hopkins/Gorman Road, Concept 1, and Seneca Drive, Concept 4, are a roofing and kennel business, respectively. The businesses employ approximately ten employees. The businesses should be able to relocate in the area. A lead time of 12 to 15 months is required to complete all relocations.

In the event, although unlikely, that comparable replacement housing is not available to rehouse persons displaced by public projects or that available replacement housing is beyond their financial means, replacement "housing as a last resort" would be utilized to accomplish the rehousing. Detailed studies must be completed by the State Highway Administration before "housing as a last resort" can be utilized.

The "Uniform Relocation Assistance and Real Property Acquisition Policies Act of 1970" requires that the State Highway Administration shall not proceed with any phase of any project which will cause the relocation of any persons, nor proceed with any construction project until it has furnished satisfactory assurances that the above payment will be provided and that all displaced persons will be relocated satisfactorily to comparable decent, safe, and sanitary housing within their financial means or that such housing is in place and has been made available to the displaced person.

TITLE VI STATEMENT -- It is the policy of the Maryland State Highway Administration to ensure compliance with the provisions of Title VI of the Civil Rights Act of 1964, and related civil rights laws and regulations which prohibit discrimination on the grounds of race, color, sex, national origin, age, religion, physical or mental handicap in all State Highway Administration programs projects funded in whole or in part by the Federal Highway Administration. The State Highway Administration will not discriminate in

TABLE 20

DISPLACEMENTS

<u>SEGMENT</u>	<u>LOCATION</u>	<u>CONCEPT</u>	<u>STRUCTURE TYPE</u>	<u>NUMBER OF STRUCTURES</u>
VI	Old Columbia Road	3	Auxiliary Use	1
VI	Hopkins/Gorman Road	1	Commercial/Residential (owner occupied)	1
VII	Rivers Edge Road	4	Residential	1
VIII	Seneca Drive	3	Residential (tenant occupied)	1
		4	Residential (owner occupied)	2
			Residential (tenant occupied)	1
			Commercial	1
		5	Residential (owner occupied)	1
			Residential (tenant occupied)	1
		5a	Residential (owner occupied)	2
			Residential (tenant occupied)	1
5b	Residential (owner occupied)	1		
	Residential (tenant occupied)	1		

highway planning, highway design, highway construction, the acquisition of right-of-way, or the provision of relocation advisory assistance. This policy has been incorporated into all levels of the highway planning process in order that proper consideration may be given to the social, economic, and environmental effects of all highway projects. Alleged discriminatory actions should be addressed to the Equal Opportunity Section of the Maryland State Highway Administration for investigation.

C. NEIGHBORHOODS

Neighborhood characteristics have been described in Section I of this document. Most residential areas have developed as subdivision units with access roads to U.S. Route 29. Very few residences abut or directly access U.S. Route 29 with individual driveways. Impacts to neighborhoods are limited to accessibility issues and changes in travel patterns.

As major highways such as U.S. Route 29 become congested, motorists often seek alternate routes through adjacent neighborhoods to avoid delays and increased travel time. As opposed to local traffic, this diverted through traffic often cause adverse neighborhood impacts from increased volumes and speeds. The No Build Alternate and Build Alternate B would retain signalized intersections on U.S. Route 29. The interchange projects to be constructed by other studies would eliminate several existing signalized intersections at Maryland Route 216, Owen Brown Road, and Columbia's south entrance. Two remaining signalized intersections that would cause increased volumes of traffic to cut through neighborhoods at peak periods are at Hopkins-Gorman Road and Seneca Drive. The affected neighborhoods include Hammond, MacGills Commons, and Clemens Crossing.

Alternate C would change the accessibility to and from some adjacent neighborhoods, as summarized in Table 21.

Significant neighborhood development is predicted at Hillcrest Heights, northwest of Maryland Route 108 in the Village of Dorsey Search, and south of Ellicott City. Congested traffic conditions would slow the development of these areas. Alternate C would encourage use of Maryland Routes 216, 108, and 103, and U.S. Route 40. The Build Alternate would enhance the growth potential of neighborhoods adjacent to these routes.

Overall project effects on area neighborhoods would be minimal, primarily because of the spatial distribution of communities within the corridor. All subdivisions occur totally on either the west or east side of U.S. Route 29, and neighborhood boundaries do not extend across the roadway. Proposed improvements to U.S. Route 29 would not bisect any existing or proposed residential communities nor present any barriers to neighborhood interaction. The project would have no significant effect on neighborhood travel patterns or community cohesion.

Because the commuter bus services access neighborhoods, there would not be an impact on social groups such as the elderly and physically handicapped who may be dependent upon public transportation.

TABLE 21  
"ALTERNATE C" CONCEPTS--EFFECTS ON NEIGHBORHOODS

<u>CONCEPT</u>	<u>AFFECTED NEIGHBORHOOD</u>	<u>DESCRIPTION OF POTENTIAL EFFECT</u>
Segment VI-Concept 2: Extending Hammond Parkway	Hillcrest Heights Hammond Parks Hammond Village	Adds traffic to neighborhood streets
Segment VI-Concept 3: Extending Crest Road from Hammond Hills	Hillcrest Heights	Encourages development
Segment VIII-Concepts 3, 4, 5, 5a, and 5b Seneca Drive to Martins Road	Clemens Crossing	Adds traffic to neighborhood streets  Increases east/west access
Segment VIII-Concepts 1, 2: Gales Lane	Talbott Springs Stevens Forest	Adds traffic to neighborhood streets
Segment IX-Concept 3: Pepple Drive/Diamondback Drive	Guilford Downs	Reduces traffic to neighborhood streets
Segment X-Concept 2: Spring Valley Road	Columbia Hills	Increases travel time to neighborhood

**D. COMMUNITY FACILITIES AND SERVICES**

The existing community facilities and services are depicted in Figure 7. They include emergency services, educational facilities, recreational facilities, health care facilities, and churches.

**1. Transportation**

Each alternate's ability to meet the transportation goals of the County is a significant measure of the alternate's impact on transportation. The No Build Alternate would not be compatible with the transportation goals and does little to respond to identified transportation deficiencies within the corridor. The Build Alternate B would upgrade U.S. Route 29 to six lanes, but would leave signalized intersections and access points intact. Transportation recommendations by the Howard County Office of Planning and Zoning not addressed by Alternate B are: (1) full control of access and (2) primary focus on the service function of the highway. Alternate C would meet all identified transportation goals and would have the greatest ability to meet projected transportation demand and improve safety by allowing access only at major interchanges.

The alternates would have limited effect on bicycle and pedestrian paths and public transportation. Because neighborhood boundaries generally do not extend across U.S. Route 29, pedestrian and bicycle travel across the roadway is minimal. Pedestrian and bicycle movement would not be affected. Safety hazards associated with crossing U.S. Route 29 would continue with the No Build Alternate. Alternate B would be even more of a hazard to bicycle and pedestrian movement with the addition of two lanes and no grade separation. Alternate C would limit pedestrian and bicycle crossing of U.S. Route 29 to major interchanges. Sidewalks would be provided on all bridge crossings, making access safer than current conditions.

In all Alternates, the commuter transit would operate as it currently exists on U.S. Route 29, with bus stops located in neighborhoods and at park-and-ride lots. Alternate C would provide faster transit trips. The existing park-and-ride lots would be moved within the same general area with interchange projects at Maryland Route 103, 216, and Broken Land Parkway. Alternate C would provide quicker access to the park-and-ride lots.

Impacts on traffic flow during construction would be minimal. Some slowing would occur as traffic patterns are changed; however, two lanes north and south would be opened at all times. No detouring of traffic is foreseen at this time.

**2. Emergency Services**

The interchange improvements to U.S. Route 29 would help to shorten the response times throughout the corridor of police, fire, and emergency services. However, the four-lane highway in the No-Build Alternate would continue to impede travel time during peak periods and cause longer trip time for emergency services. Alternate B would reduce travel time because traffic flow would improve with the additional lanes. Neither Alternates A nor B would affect emergency vehicle access to neighborhoods.

Alternate C would offer the fastest response time on the highway system overall. Because of reduced access points along U.S. Route 29, however,

response times might increase to certain neighborhoods. An example would occur in Segment IX at Pepple Drive in the Village of Long Reach, the Guilford Downs neighborhood. Concept 1 and 3 in this area would close Pepple Drive, causing a longer response time for emergency vehicles from Columbia Co. 7 (see Figure 7) via Diamondback Drive or Maryland Route 175 to an emergency on Pepple Drive. Similar impacts would occur in Segment VI at Old Columbia Road, Concept 1; Segment VIII at Gales Lane, Concept 2; Segment IX at Old Columbia Road, Concept 2; and Segment X at Spring Valley Road, Concept 2. Service to Martins Road would be improved with all concepts provided for Seneca Road in Segment VIII. None of the alternates would impact the WSSC emergency boat ramp at Harding Road in Segment VI. Old Columbia Road would be closed by a gate in Concepts 2 and 3, allowing access only to emergency vehicles.

### 3. Health Care Facilities

The U.S. Route 29 highway project would have no significant impact on health care facilities other than previously mentioned effects on travel time. Access improvements to Howard County General Hospital would be realized with the completion of the Broken Land Parkway. All other facilities are located outside the study area.

### 4. Educational Facilities

Potential impacts on school bus service is a major concern of the Howard County Public School System (Letter in Section V). Potential impacts of the project alternates on the transport of school children focus in two areas: safety and bus route adjustments. Section I describes schools that potentially would be affected because they: have buses currently accessing U.S. Route 29 through left turn movement at an at-grade intersection; have attendance areas on both sides of U.S. Route 29; and have students residing immediately adjacent to U.S. Route 29.

Alternates A and B would retain signalized intersections on U.S. Route 29, with cross traffic and left-turn movements. School buses would need to continue to negotiate these intersections, and increasing traffic volumes and congestion would reduce safety and increase the risk of accidents significantly. Travel time also would be increased as traffic volumes and congestion on U.S. Route 29 increase.

Alternate C provides limited access and grade-separated interchanges. Several streets and roads would be dead-ended at U.S. Route 29 and direct access no longer would be permitted. All access to U.S. Route 29 would be at interchanges. Some bus routes would be removed from U.S. Route 29. Although this change in access would require an adjustment of school bus routes, safety would be increased significantly. The crossing of U.S. Route 29 by school buses to service both sides of the highway also would be significantly safer because grade-separated interchanges and overpass ramps would eliminate the at-grade vehicle conflicts associated with existing signalized and nonsignalized intersections.

Concepts that would improve safety for travel to educational facilities, and the facilities affected are:

- Segment VI, Concept 2 at Old Columbia Road (Atholton High School)

- . Segment VI, Concepts 2 and 3 at Hammond Drive and Hillcrest Drive (Hammond Elementary and Middle School and Atholton High School)
- . Segment VI, Concept 1 at Hopkins/Gorman Road (Hammond Elementary and Middle School, and Atholton High School)
- . Segment VII, at Rivers Edge Road (Clemens Crossing Elementary School, Clarksville Middle School, and Atholton High School)
- . Segment VIII, all proposed concepts at Seneca Drive and Gales Lane (Clarksville Middle School and Oakland Mills High School)

Although it would provide much safer operating scenarios for school buses, the selection of Alternate C would result in adjustments to routes and, at times, would produce longer trips as a result of median closures and the use of service roads and alternate routes. Concepts affecting school bus travel times, and the schools affected, include:

- . Segment VI, Concepts 1 and 3 at Old Columbia Road (Hammond Elementary School, Clarksville Elementary School, Hammond Middle School, and Clarksville Middle School)
- . Segment VI, Concept 1 at Hammond Drive and Hillcrest Drive (Hammond Elementary School and Oakland Mills Middle and High Schools)
- . Segment IX, Concept 1 at Old Columbia Road (Talbot Elementary School and Oakland Mills Middle and High Schools)
- . Segment IX, both concepts at Pepple Drive and Diamondback Drive (Oakland Mills Middle School and Howard High School)
- . Segment X, Concept 2 at Spring Valley Road (Northfield Elementary School, Dunloggin Middle School and Centennial High School)

**5. Religious Facilities**

Four existing churches that the project would affect are: Locust United Methodist, Christ Memorial Presbyterian, Epiphany Lutheran, and the Atholton Seventh Day Adventist. Alternates A and B, by allowing cross traffic and left turn movements at Epiphany Lutheran, would create a hazardous condition. Alternate C at Seneca Drive to Martins Road would improve access to Locust United Methodist and Christ Memorial Presbyterian, and the Atholton Seventh Day Adventist. Concept 2 at Spring Valley Road in Segment X would sever all access to U.S. Route 29, making access to Epiphany Lutheran more circuitous.

**6. Parks**

No impacts on area parks would occur with the implementation of any of the project alternates.



E. HISTORIC AND ARCHEOLOGICAL RESOURCES

No property will be required from the historic sites identified as possibly eligible for the National Register of Historic Places by any alternate.

Scaggs Place is located in the southwest quadrant of the U.S. Route 29 and Hopkins-Gorman Road intersection where an overpass may be constructed, and two additional lanes would be constructed within the median. A ramp would be constructed within the southwest quadrant of the intersection; however, it would be located over 450 feet from the dwelling at Scaggs Place.

Athol is located near the U.S. Route 29/Seneca Drive intersection. The five interchange options being considered as part of Alternate C would include construction of a ramp north of Athol. Extensive vegetation would shield the buildings from the proposed ramps.

Kelly's Store House, the Gales-Gaither House and Felicity are located on Old Columbia Pike south of Maryland Route 175. Alternate C, Concept 2 at Old Columbia Road in Segment IX proposes the extension of Old Columbia Pike around Felicity. It would turn to the east and connect with Twin Knolls Road on new right-of-way in an area reserved as easement by Howard County. Access to U.S. Route 29 would be severed with Concept 2, and a turnaround would be constructed between Felicity and the Gales-Gaither House. Alternate C, Concept 1 at Old Columbia Road in Segment IX would maintain Old Columbia Pike as an access road to U.S. Route 29.

Alternate C, Concept 2 at Old Columbia Road in Segment IX, would effect Kelly's Store House and the Gales-Gaither House, but the effect would not be adverse. A no adverse effect determination for Felicity, on the other hand, would be dependent upon the development of a landscaping plan for the right-of-way associated with the connection to Twin Knolls Road. This plan, to shield the view of the road from the house, would be submitted to the State Historic Preservation Officer for his review in the design phase of the project.

Dorsey Hall and Long Reach, located north of Maryland Route 108 in Segment X, are located far enough from U.S. Route 29 that they would not be impacted by proposed improvements.

The Maryland Geological Survey, Division of Archeology, stated that an archeological survey was not required as the proposed improvements occur in existing medians or along road berms (See letter in Section V). Concurrence with these findings has been requested from the State Historic Preservation Officer.

F. ECONOMIC IMPACTS

1. Economic Activity

Major highway improvements often are seen as one catalyst to economic activity. Benefits to industries locating along major highways are derived from the industries' dependence on the transport industry. Transport-sensitive industries require adequate, efficient highways. As mentioned in Section I, the vitality of the area is dependent on how well the basic industries can survive in the area. Planned development areas that are sensitive to transportation improvements are the basic employment and planned employment center categories of the land use plan.

Without an efficient transportation system on U.S. Route 29, transport-sensitive industry would not be enticed to develop within the highway corridor. The No Build Alternate would have the potential to effectively halt industrial growth in the corridor. Both Build Alternates would increase highway capacity to meet future travel demand, thus eliminating a major potential constraint to development. Prime industrial locations occur presently at major interchanges and intersections. The development of major interchanges would encourage further industrial development. Specifically, with construction of the Hopkins/Gorman interchange and the developing high-tech society, it can be expected that positive inducements for development would occur at the planned employment center southwest of the new interchange. A secondary response to this development would be concurrent, adjacent low-density residential development. Limited access might hinder development of the basic employment area located between Maryland Route 108 and Maryland Route 103. The degree to which other development in basic employment areas occurs is dependent upon the interchange concepts for Maryland Route 216 and Maryland Route 108.

The retail and service segments of the area economy are dependent on the short-term trips and easy access from U.S. Route 29. The No Build Alternate would increase peak-hour congestion on U.S. Route 29 and negatively affect short-term shopping trips during peak hours. Retail and service establishments dependent on local patronage would be impacted adversely by this alternate. New growth of retail and service industries would not occur as rapidly under the No Build Alternate as with the Build Alternates.

The Build Alternates, by eliminating left on and off movement, would not affect most retail and service markets since the markets occur at existing or improved intersections. Because of reduced traffic congestion, retail and service patrons would enjoy improved access. Growth would be encouraged by the improved access. However, south of Maryland Route 175, access to several retail establishments located adjacent to Old Columbia Road in Segment IX would be circuitous.

Inadequate and inefficient transportation systems affect the desirability of adjacent land. Highway improvements can have positive incremental effects on land values, particularly the land adjacent to major interchanges. Traffic congestion would reach the worst-case scenario by the Year 2000 with the No Build Alternate, thus reducing the attractiveness for development in the U.S. Route 29 Corridor and correspondingly decreasing land values. Alternate B would result in less severe congestion on U.S. Route 29 than Alternate A, but would retain hazardous at-grade intersections. Resultant unsafe access and limited capacity would affect land values more in the housing market than in other market segments. By reducing hazardous conditions and alleviating traffic congestion, Alternate C would stabilize, and possibly increase, residential land values.

## 2. Taxes and Revenue

A very important economic consideration in the analysis of the effects of a highway project is the impact on area taxes and revenues. Given a worst-case scenario, that is, assuming the most expensive right-of-way requirement in each segment, that is, assuming the most expensive right-of-way requirement in each segment is chosen plus displacements, the cost would be \$2,519,075. Assuming an estimated assessment rate of 50% of market value, property tax revenue lost would be less than .01 percent of total property tax revenues. Negative effects on tax revenues are relatively negligible. Positive effects

will occur if the inducement of better transport conditions encourages businesses to locate in the corridor. Business, in general, supports a proportionately higher share of the tax base than residences.

## G. NATURAL ENVIRONMENT

The information contained in this Section of the Environmental Assessment is a summary of the environmental impacts contained in the Natural Resources Analysis Report prepared for this project. More detailed information is provided in the Natural Resources Analysis Report.

The No Build Alternate would produce no impacts on the study area's natural resources.

### 1. Surface Water

The majority of the streams crossed by U.S. Route 29 would not be impacted by roadway widening, since widening would be within the existing median over culverts or pipes already in place and would not involve the extension of culverts or pipes. The main U.S. Route 29 crossing of the Middle Patuxent at Station 795 (See Detailed Alternates Mapping, Sheet 3 of 8) would involve new construction over the waterway. Bridge widening at the Little Patuxent River was included in the Broken Land Parkway study, and thus is not included in this analysis.

Construction at the Middle Patuxent River for Alternates B and C would include widening the bridge within the center of existing U.S. Route 29 to provide for an additional northbound lane. The existing northbound piers on the banks of the River would be extended. Construction at the piers would disturb 240 square feet of vegetated area. Erosion and sediment control procedures developed during final design would be used to mitigate the impact of stream sedimentation. Rock rip-rap would be placed behind the piers. No construction equipment would be located within the stream or cross the stream. All construction activities would occur within, or behind, the confines of sheet piling around the piers.

Many of the Alternate C concepts would also have an impact on area tributaries. In all cases, construction activities would be limited to the extension of existing culverts or placement of new culverts to convey tributaries beneath ramps or service road.

- . At Old Columbia Road in Segment VI, the proposed new service road of Concept 2 would cross two intermittent tributaries of the Patuxent River. The Concept 3 service road would cross three intermittent tributaries (See Detailed Alternates Mapping, Sheet 1 of 8).
- . The extension of Hammond Parkway included in Concept 2 at Hammond and Hillcrest Drives would cross Hammond Branch and an intermittent tributary (See Detailed Alternates Mapping, Sheet 2 of 8).
- . At Hopkins-Gorman Road, Concept 1 would involve three additional crossings of an intermittent tributary of the Middle Patuxent River. The new service road of this Concept

would require two new crossings; and the ramp that parallels the service road would require one new crossing (See Detailed Alternates Mapping, Sheet 2 of 8).

- . Concepts 3 and 4 at Rivers Edge Road in Segment VII include ramps crossing a small tributary north of the Middle Patuxent River at three locations (See Detailed Alternates Mapping, Sheet 3 of 8).
- . The existing culvert at Beaver Run would be extended on the west side of U.S. Route 29 by Concept 3 at Seneca Drive. This culvert would be extended on both the east and west side of the highway by Concepts 4, 5, 5a, and 5b. An intermittent tributary west of U.S. Route 29 would be crossed by Concepts 3, 4, 5, 5a, and 5b (See Detailed Alternates Mapping, Sheet 4 of 8).
- . Construction of the service road at Gales Lane, Concept 2, would require a new crossing of a Little Patuxent tributary (See Detailed Alternates Mapping, Sheet 5 of 8).
- . Concept 2 at Twin Knolls Road would require extension of the existing culvert at a tributary to the Little Patuxent River just east of U.S. Route 29 (See Detailed Alternates Mapping, Sheet 6 of 8).
- . Concepts 1 and 3 at Pepple and Diamondback Drives would necessitate extension of the existing culvert for a tributary of Little Patuxent River at Maryland Route 175 to accommodate a proposed ramp (See Detailed Alternates Mapping, Sheet 7 of 8).

For all of the concepts discussed above, extending existing culverts or placing new culverts would disturb stream bottoms of the affected tributaries. The existing aquatic community generally would be destroyed in a disturbed area. Highly mobile species, such as fish, would leave the immediate area during construction, and reinhabit nearby areas following completion of construction activities. Mitigation measures to reduce the impact on the aquatic community would include erosion control measures, and avoidance of habitat disturbances where possible.

The glassy darter (Etheostoma vitreum), a fish species designated as rare by the Maryland Natural Heritage Program, is found in the Middle Patuxent River. The Natural Heritage Program is concerned that any siltation or substrate alteration at this site would impact this population (letter in Section V). Construction activities to widen the bridge over the Middle Patuxent River would be limited to extending existing piers on the banks of the stream, disturbing approximately a 240-square-foot area. Siltation would be mitigated through erosion and sediment control procedures, and the use of sheet piling around the construction area. No substrate alteration would occur. No significant impact on population characteristics of the glassy darter would be expected.

The Natural Heritage Program also notes that Stygobromus t. potomacus and Stygobromus pizzinni, two rare amphipods, are found in a few small streams

adjacent to U.S. Route 29, just south of Maryland Route 40. However, the nearest construction activities would be two miles south of Maryland Route 40, and thus no impact is expected.

During construction activities and placement of new culverts at the area tributaries, any erodible materials that may be exposed along the waters would result in an increase in sedimentation and turbidity. The removal of any vegetation from the banks would not only expose additional soils to run-off, but would remove the protective strip that aids in intercepting runoff. Most of the tributaries affected by construction have rather flat, vegetated banks, and the majority of stream bottoms are silt. Thus, the removal of vegetation and disturbance of silt bottoms would create some increase in sedimentation. Construction at the new crossing of Hammond Branch would have a greater potential for producing sedimentation because of the steep terrain on the southern side of the stream.

The actual amount of sedimentation occurring at the tributaries is dependent on many variables, including time of year of construction, amount of time ground is exposed, rainfall intensity during the time ground is uncovered, and distance of construction from streams. Although a potential exists for temporary sediment loading of surface waters, proper erosion control measures can mitigate this impact successfully.

Final design for the proposed improvements would include "Standard Erosion and Sediment Control Procedures" as specified by the Maryland State Highway Administration, as well as the Maryland Department of Natural Resources - Water Resources Administration's (WRA) standards and specifications.

The "1983 Maryland Standards and Specifications for Soil Erosion and Sediment Control<sup>10</sup>" require that an erosion and sediment control plan be followed. The purpose of the plan is to control accelerated erosion and sedimentation resulting from land-disturbing activities of highway construction and maintenance operations.

The basic control objective of the plan are to:

- (1) Minimize disturbance of existing topography and avoid sensitive areas, where possible.
- (2) Pay special attention to critical areas that must be disturbed, and stage clearing and grading to limit the area and time of exposure.
- (3) Control erosion and sedimentation in small drainage areas by controlling erosion at its source.
- (4) Utilize vegetative controls (such as mulching, seeding, and sod), and structural controls (such as silt fences, straw bales, dikes, diversions, waterways, and sediment basins) when erosion cannot be controlled by vegetative means.

Additionally, in January 1986, the Waterway Permits Division of the Water Resources Administration published "Maryland's Guidelines to Waterway Construction<sup>11</sup>" to complement the the "Standard and Specifications for Soil Erosion and Sediment Control Manual." This book details frequently encountered

techniques used in the waterway construction process and provides a practical application of many of the standard sediment-control practices. These guidelines will be followed in developing the sequence of construction for this project. Outlined in the guidelines are sediment-control devices, temporary stream-diversion techniques, slope protection techniques, channel rehabilitation, and general guidelines for culverts and bridge installation.

Full and rigorous implementation and enforcement of erosion and sediment-control measures will be conducted. Plans for grading also must be included in the final design. All plans must be developed in accordance with state and federal laws and regulations, and require review and approval by the WRA and the Department of Health and Mental Hygiene - Office of Environmental Programs (OEP).

A Waterway Construction Permit may be required during the final design phase for each of the crossings affected. In addition, no in-stream work will be permitted from March through May, inclusive, for Class IV waters (Patuxent River tributaries) and from March through June 15, inclusive, for Class I waters (all other area streams).

One stream relocation would be required by Concept 1 at Hopkins-Gorman Road. Construction of the service road between Hopkins/Gorman Road (Segment VI) and Old Columbia Road (Segment VII) would necessitate rechannelization of approximately 610 feet of an intermittent tributary of the Middle Patuxent River. A new stream channel would be constructed east of the existing location. The stream length of the relocated section would be maintained at 610 feet. To the extent possible, existing slope and grades would be maintained. Rocks and gravel would be placed randomly within the new channel to encourage rapid naturalization of the stream bed and development of a pool/riffle sequence. The banks of the new channel would be stabilized before diverting the flow of the stream from the old to the new channel.

Bottom-dwelling organisms and the aquatic habitat of the existing section of stream (to be relocated) would be destroyed. However, the new section of stream soon would be naturally reestablished with flora and fauna from the upstream reaches of the stream, replacing that which was lost. The reestablishment with flora and fauna is predicted to occur rapidly because of the limited stretch of stream that would be affected (610 feet) and the low gradient of the stream.

Because there would be no loss in stream length and because a natural stream channel would be used, no significant scouring is expected from the relocated section. Erosion and sedimentation occurring during construction would be mitigated through erosion and sediment-control procedures developed during final design. After stabilization of the new channel, no long-term erosion impacts would occur.

The predominant continuing impact on the area tributaries would be the discharge of runoff from the roadway. The increase in impervious strata resulting from roadway widening and from the construction of Alternate C concepts would produce a proportionate increase in the amount of runoff carrying vehicle-generated pollutants. Stormwater runoff would be managed under DNR's Stormwater Management Regulations and would be in compliance with COMAR 05.08.05.05. Stormwater management practices under these regulations may include:

- . on-site infiltration
- . flow attenuation by open vegetated swales and natural depressions
- . stormwater retention structures
- . stormwater detention structures

These measures can significantly reduce pollutant loads and control runoff. The Fisheries Division of Water Resources Administration insists that the proposed work produce zero additional degradation from stormwater management operations. (See letter in Section V).

The rapid movement of water over bridges and roadway surfaces carries quantities of grease, oil drippings, deicers, and exhaust emissions into the surface waters, and possibly the groundwater as well. Although the increase in impervious surface would cause an increase in runoff pollutants, these impurities would be dispersed and diluted upon entrance into the waters. Stormwater management ponds provided during construction activities will aid in this dilution through the settling of pollutants and the increased detention time of pollutants. Therefore, the impact from run off pollutants would not be expected to be of such a magnitude to affect the biological or chemical character of the water. Dispersion and dilution do not eliminate pollution; however, many petroleum pollutants, such as grease and oil drippings, are broken down eventually into less harmful products through bacterial action.<sup>12</sup>

The proposed project would not involve the use of hazardous materials, with the exception of fuel oils and lubricants. Accidental spills of these products could cause a significant impact on area streams. However, the probability of spills is low, and the contractor would be required to maintain cleanup equipment on site in case of a spill.

### 2. Groundwater

The increase in impervious strata resulting from roadway widening or construction of any of the Alternate C concepts is not expected to impact the area groundwater recharge potential significantly because of the relatively small area impacted compared to the total impervious area of U.S. Route 29. Also, the increase in overall paved surface would not increase the concentration of runoff impurities into the groundwater, when compared with the total contribution of pollutants to the aquifer.

The appropriate stormwater management procedures, described in the previous section, would be applied to adequately control runoff and reduce pollutants.

Accidental spills of fuel oil and lubricants constitute a possible source of groundwater contamination. However, the probability of spills is low; and the contractor would be required to maintain cleanup equipment on site in case of a spill.

### 3. Wetlands

The maximum acreage of wetlands impacted by Alternates B and C is given on Table 22. Assuming the selection of the worst-case concept in each Segment, the maximum amount of wetlands affected would be approximately 1.23 acres.

TABLE 22  
WETLAND IMPACTS

	WETLAND NUMBER IMPACTED*	MAXIMUM ACREAGE REQUIRED				TOTAL (acres)
		PALUSTRINE, FORESTED (PF01A) (acres)	PALUSTRINE, SCRUB/SHRUB (PSS1A) (acres)	PALUSTRINE, EMERGENT (PEM5A) (acres)	PALUSTRINE, SCRUB/ SHRUB EMERGENT (P[SS1/EM5]A) (acres)	
Roadway Widening (All B & C Alternates)	#5		0.006			0.006
<u>Concepts</u>						
2 @ Hammond Drive	#3	0.4		0.1		0.5
3 @ Rivers Edge Road	#6		0.2			0.2
4 @ Rivers Edge Road	#6		0.1			0.1
3 @ Seneca Drive	#12	0.2				0.2
4 @ Seneca Drive	#11&#12	0.2	0.02			0.22
5 @ Seneca Drive	#11&#12	0.2	0.02			0.22
5a @ Seneca Drive	#11&#12	0.2	0.02			0.22
5b @ Seneca Drive	#11&#12	0.2	0.02			0.22
2 @ Gales Lane	#13	0.1				0.1
2 @ Old Columbia Road (Twin Knolls)	#18				0.1	0.1
1 @ Pepple Drive/ Diamondback Drive	#19				0.1	0.1
3 @ Pepple Drive/ Diamondback Drive	#19				0.1	0.1

PF01A = Palustrine, Forested, Broad-leaved Deciduous, Temporarily Flooded  
PSS1A = Palustrine, Scrub/Shrub, Broad-leaved Deciduous, Temporarily Flooded  
PEM5A = Palustrine, Emergent, Narrow-leaved Persistent, Temporarily Flooded

\* The location of each numbered wetland is described in Section I, and shown on the Detailed Alternates Mapping in Section III.



Widening U.S. Route 29 would impact one wetland associated with the Middle Patuxent River crossing (Wetland #5, on Detailed Alternates Mapping, Sheet 3 of 8). As discussed under surface water impacts (Section IV.G.1), approximately 240 square feet (.006 acres) of wetlands along the banks of the river would be destroyed to extend the two existing piers for the additional lane. The affected wetlands function mainly to anchor the shoreline. All other roadway widening would be within the existing highway median over existing culverts, or was included under previous studies (i.e., Little Patuxent River crossing).

- . At Hammond Drive, the Concept 2 impact would occur adjacent to Hammond Branch for the extension of Hammond Parkway to Hammond Drive (See Detailed Alternates Mapping, Sheet 2 of 8). The functions Wetland #3 serve include sediment trapping, food chain support, and fish and wildlife habitat.
- . At the Rivers Edge location, impact to Wetland #6 would be a result of the placement of a new culvert for a ramp crossing of a tributary of the Middle Patuxent River (See Detailed Alternates Mapping, Sheet 3 of 8). This wetland functions mainly for sediment trapping.
- . Concepts 4, 5, 5a, and 5b at Seneca Drive impact Wetland #11 by extending the culvert on the east side of U.S. Route 29. The functions of the impacted wetland are sediment trapping and fish habitat. Wetland #12 would be affected under Concepts 3, 4, 5, 5a, and 5b at Seneca Drive by the extension of the culvert on the west side of U.S. Route 29 (See Detailed Alternates Mapping, Sheet 4 of 8). This wetland functions as a wildlife habitat and for nutrient cycling and sediment trapping.
- . Wetland #13, affected by the extension of the roadway of Concept 2 at Gales Lane, functions primarily for nutrient cycling (See Detailed Alternates Mapping, Sheet 5 of 8). Other functions include wildlife habitat and sediment trapping, and food chain support.
- . Concept 2, the roadway to Twin Knolls Road, would impact Wetland #18 by extending the culvert on the east side of U.S. Route 29 (See Detailed Alternates Mapping, Sheet 6 of 8). This wetland functions as wildlife habitat and for sediment trapping.
- . Concepts 1 and 3 at Pepple/Diamondback Drive would require the extension of the existing culvert near the Maryland Route 175 ramp to straighten and lengthen this ramp (See Detailed Alternates Mapping, Sheet 7 of 8). The affected wetland (Wetland #19) functions as a fishery and wildlife habitat and for sediment trapping.

In accordance with E.O. 11990, coordination with the U.S. Fish and Wildlife Service (FWS) and other concerned agencies has been conducted to assist in the evaluation of impact significance and possible mitigation strategies. Additionally, a wetlands field view was conducted in October, 1986 with the FWS and Maryland Department of Natural Resources. A consensus was reached among the agencies attending the field view regarding the presence and classification

of the impacted wetlands. The agencies commented on the significance of impact and offered mitigation suggestions. Minutes from the wetlands field view are contained in Section V.B.

The State Highway Administration will replace impacted wetlands on a 1:1 basis. An exception to the 1:1 replacement occurs at Wetland #5, which the FWS determined would not be necessary to replace because the amount disturbed (240 ft<sup>2</sup>) would soon revegetate if proper mitigation measures were employed (See minutes of field view in Section V.B.). Replacement options on site and off site are being considered to mitigate the project's impact on wetlands. Other mitigation measures include: limiting the amount of vegetation taken, using silt fences or temporary berms during construction, enforcing erosion (and sediment control measures, and minimizing the slopes of replacement wetlands to 1½:1. These recommendations would be considered during final design.

The ponds in the project area function for stormwater management and sediment trapping. None of the ponds would be impacted directly by any of the project alternates. The potential impact on the ponds would be limited to the possible indirect impacts of sediment transport occurring during construction activities. This impact could be mitigated successfully through proper implementation of erosion- and sediment-control procedures. Some of the erosion- and sediment-control measures that could be used include silt fences and temporary berms.

Wetlands #1, #2, #4, #7, #8, #9, #10, #14, #15, #16, #17, and #19 would not be impacted directly by any of the project alternates.

The wetlands analysis was conducted in accordance with Executive Order 11990, Protection of Wetlands, because the project might involve transportation use of wetlands, depending on the Alternate and/or concepts selected. All possible mitigation measures would be incorporated into project design to minimize wetlands impacts, including erosion- and sediment-control procedures, and replacement of wetlands.

Alternates B and C require the acquisition of 240 square feet of wetlands for widening of the U.S. Route 29 bridge over the Middle Patuxent River. Traffic characteristics render it infeasible to widen U.S. Route 29 without widening the bridge.

The wetlands acquisitions required by Alternate C concepts are mainly for construction of service roads or for required roadway connections. Where possible, concepts avoiding wetland also are included among the project alternates. These avoidance concepts include closing cross-overs and intersections, but allowing right-on/right-off access. However, the C Concepts that eliminate all access maximize the safety and capacity along U.S. Route 29.

4. Floodplains

The maximum acreage of floodplains impacted by Alternates B and C is given in Table 23. Based on the worst-case concept in each segment, the maximum amount of floodplain encroachment would be approximately 2.0 acres.

Widening U.S. Route 29 (Alternates B and C) would encroach on the 100-year floodplain of the Middle Patuxent River by extending the existing bridge piers approximately 240 square feet (See Detailed Alternates Mapping,

TABLE 23  
FLOODPLAIN IMPACTS

<u>Alternates</u>	<u>Acreage Within 100-Year Floodplain</u>		
	<u>Hammond Branch (acres)</u>	<u>Middle Patuxent River (acres)</u>	<u>Little Patuxent River (acres)</u>
Roadway Widening for All B & C Alternates:		.006	0.8
Alternate C Concepts:			
Concept 2 @ Hammond Drive	0.8		
Concept 2 @ Gales Lane			0.4

Sheet 3 of 8). The bridge widening should not have a significant impact on floodplain capacity or function.

U.S. Route 29 lies within the floodplain of the Little Patuxent River in Segment IX. Widening in the median of U.S. Route 29 would place one additional 12 foot lane in each direction, for a length of approximately 1500 feet, within the floodplain (See Detailed Alternates Mapping, Sheets 5 and 6 of 8). Therefore, new roadway would be placed within 0.8 acres of floodplain.

Two of the project Alternate C concepts would require construction within the 100-year floodplain. Extending Hammond Parkway to Hammond Drive in Concept 2 would involve filling approximately 0.8 acres within the 100-year floodplain of Hammond Branch for placement of a culvert (See Detailed Alternates Mapping, Sheet 2 of 8). In Concept 2 at Gales Lane, approximately 0.4 acres of floodplain would be filled for placement of a culvert (See Detailed Alternates Mapping, Sheet 5 of 8).

In accordance with the requirements of Executive Order 11988, Floodplain Management, and FHPM 6-7-3-2, each floodplain encroachment was evaluated to determine its significance. Where practicable, longitudinal and significant encroachments in the 100-year floodplain should be avoided. Roadway widening within the median of U.S. Route 29 is considered a longitudinal encroachment since the roadway is within the 100-year floodplain.

Because the existing roadway is within the floodplain, roadway widening cannot avoid impact within the floodplain. If Alternate B or C is selected, detailed surface hydrology studies would be conducted during the final design stages of the project. These studies would identify the quantity of fill to be placed within the floodplain and the resultant impact on the passage of flood waters. The studies cannot be completed until the engineering design develops to a point when this detail of information is available. These studies are normally part of the Section 404 permitting process during final design prior to construction.

All other encroachments would be transverse crossings of the floodplains. Transverse crossings are considered insignificant if they do not: 1) interrupt or terminate a community's only evacuation routes, 2) significantly affect the natural and beneficial floodplain values in the area, or 3) produce an increased risk associated with flooding, such as property loss or hazard to life. The Concept 2 Gales Lane floodplain involvement would meet these criteria, and thus would not be considered significant.

The amount of fill required at the Hammond Branch crossing would cause a loss of floodplain capacity and would create a potential problem for passage of floodwaters. All possible design measures would be incorporated to reduce this impact. The use of standard hydraulic design techniques for this, and all, waterway openings would incorporate structures to limit upstream flood-level increases and approximate existing downstream flow rates. Under the National Flood Insurance Program, actions involving placement of facilities are subject to the requirements that the cumulative effect of the proposed action, when combined with all existing and proposed development, will not increase the water surface elevation of the base flood more than one foot within the community. The U.S. Route 29 project will be required to meet these requirements, negating significant adverse impact.

Construction of structures within the floodplain and possible siltation would be minimized by providing mitigative measures such as rip-rap along vulnerable portions of embankments in the floodplain. Use of state-of-the-art sediment- and erosion-control techniques and stormwater management controls would minimize risks and impacts to the beneficial floodplain values. None of the proposed floodplain encroachments would support further development within the floodplain either directly or indirectly. A Section 404 Permit from the Army Corps of Engineers would be required for Alternates B and C.

5. Vegetation

The approximate amounts of land cover types converted to roadway or other nonvegetative uses by each concept is given in Table 24. The addition of lanes for widening (Alternates B and C) would occur within the existing grass median, and would have no impact on natural vegetation.

Depending on the concept chosen in each segment, varying amounts of open land would be destroyed. The selection of the worst-case concept at each location would impact a maximum of approximately 28.8 acres of land, 16.4 acres of which would be natural vegetative communities (field, shrub, or woodlands). The maximum amount of a particular land type that would be affected by any one concept is approximately 5 acres of hardwood forest which would be required by Concept 1 at Hopkins-gorman Road. This concept also would require the greatest total amount of acreage; approximately 12.2 acres. The overall amount of land required by any option is not considered significant when compared to the total amount of open land along the corridor.

Most of the Alternate C concepts that involve the acquisition of land would require man-dominated land, ranging from approximately 0.40 acres to about 3.3 acres. About half of the concepts would involve a loss of abandoned field shrub vegetation between approximately 0.3 and 3.1 acres. Most of the concepts would require destruction of hardwood forests. Between approximately 0.1 and 5.0 acres of hardwood forest would be lost in any one Alternate C concept. Agricultural land would be affected at Concepts 2 and 3 at Old Columbia Road and Concept 1 at Hopkins-Gorman Road, in Segment VI. Concept 2 at Old Columbia Road would result in a loss of approximately 4.5 acres, and Concept 3 at Old Columbia Road would result in a loss of approximately 2.0 acres. Concept 1 at Hopkins-Gorman Road would result in a loss of approximately 0.9 acres. Impacts on agricultural land are discussed in more detail in Section IV.G.7, Farmland.

6. Wildlife

Minor impacts are expected to occur on the area's wildlife from alteration of habitat. The wildlife inhabiting the vegetated area to be affected by the project would be displaced to adjacent areas of similar habitat. Because there is adequate similar habitat available in nearby areas, the proposed highway improvements would cause no significant effects on the size or characteristics of wildlife populations in the area.

7. Farmland

This project has been coordinated with the Soil Conservation Service to determine the potential impact on prime farmland (letter and Farmland Conversion Impact Rating Form in Section V). Concepts 2 and 3 at Old Columbia Road in Segment VI would require acquisition of land designated as prime farmland.

142

TABLE 24  
LAND COVER IMPACTS

	<u>Man-Dominated</u> (Acres)	<u>Abandoned Field Shrub</u> (Acres)	<u>Hardwood Forest</u> (Acres)	<u>Agricultural</u> (Acres)	<u>TOTAL</u>
<u>SEGMENT VI</u>					
Concept 2 @ Old Columbia Road	0.4		1.0	4.5	5.9
Concept 3 @ Old Columbia Road			3.0	2.0	5.0
Concept 4 @ Old Columbia Road			0.3		0.3
Concept 2 @ Hammond&Hillcrest Dr.	0.4		0.5		0.9
Concept 3 @ Hammond&Hillcrest Dr.			0.4		0.4
Concept 1 @ Hopkins/Gorman Road	3.2	3.1	5.0	0.9	12.2
<u>SEGMENT VII</u>					
Concept 3 @ Rivers Edge Road	0.8		1.2		2.0
Concept 4 @ Rivers Edge Road	0.7		1.5		2.2
<u>SEGMENT VIII</u>					
Concept 3 @ Seneca Drive	3.3	1.3	0.2		4.8
Concept 4 @ Seneca Drive	3.2	0.7	0.1		4.0
Concept 5 @ Seneca Drive	4.0	0.6	0.2		4.8
Concept 5a @ Seneca Drive	4.0	0.6	0.2		4.8
Concept 5b @ Seneca Drive	4.0	0.6	0.2		4.8
Concept 2 @ Gales Lane			0.4		0.4
<u>SEGMENT IX</u>					
Concept 2 @ Old Columbia Road Driveway Connection	1.0		0.8		1.8
Concept 1 @ Pepple Road		0.3			0.3
Concept 3 @ Pepple Road		0.3			0.3

Two productive agricultural tracts, located in Segment VI, are designated as prime farmland and would be impacted by two of the project options. Concept 2 would require acquisition of approximately 4.5 acres of this productive prime farmland. Relocating Old Columbia Road would place approximately 2.5 acres of new roadway through productive prime farmland. Also under this concept, Service Road A would require acquisition of approximately 2 acres of productive prime farmland. Concept 3 would also affect the approximately 2 acres of productive prime farmland for construction of Service Road A.

In accordance with the Farmland Protection Policy Act of 1981, a Farmland Conversion Impact Rating Form (Form AD-1006) was completed and processed in coordination with the Soil Conservation Service. Since Howard County has developed its own Land Evaluation and Site Assessment (LESA) System, this information was used in completing the form. The relative value of the farmland to be converted was determined to be 72 for Concept 2 and 57 for Concept 3, out of a possible 100 points. The actual site assessment for the two concepts, however, was only 56 and 48, respectively, out of a possible 160 points. Therefore, the total score for Concept 2 is 128, and that for Concept 3 is 105. Sites receiving a total score of less than 160 points are to be given a minimal level of consideration for protection. Thus, the results of this process indicates that the impact on prime farmland is not significant.

Subsequent to coordination with the Soil Conservation Service, an additional concept that would impact prime farmland was included in this study. Concept C-1 at Hopkins-Gorman Road would require acquisition of approximately 0.9 acres of productive prime farmland west of U.S. Route 29 for construction of the ramp south of Hopkins-Gorman Road. Using the Howard County LESA system, the actual site assessment for this concept is 56 out of 160 points. Assuming the maximum 100 points for the relative value of the farmland (would most likely be less), the total score would be 156 points. Because the total score is less than 160 points, the impact on prime farmland is not considered significant according to the SCS process.

The agricultural area north of Hopkins-Gorman Road contains prime farmland, and would be impacted by Concept 1 at Hopkins-Gorman Road. However, because it is already committed to urban use (i.e., Montpelier Research Park), it is not considered to be prime farmlands.

Several areas of prime farmland soils that are nonproductive agriculturally also would be affected by the Alternate C concepts. Since the nonproductive areas are either residential or planned for such use, acquisition of this land is not considered an impact on prime farmland.

8. Visual Environment

The proposed project would produce minor visual changes within the project area and would not cause a significant visual intrusion or affect any sensitive or unique visual amenities. Widening existing U.S. Route 29 would have only a minimal, if any, visual impact because the two- or three-lane highway is already present. The overall regional impact would not be substantial in comparison to the total amount of natural or undeveloped areas within the project area.

During construction of the proposed project, a temporary visual intrusion would be created by the presence of construction equipment and

144

activities. Construction activities would require the removal of vegetation adjacent to the roadway during highway widening and for Alternate C concepts. The view of the highway during construction would change as traffic queues for construction activities.

#### H. NOISE

The FHWA Noise Prediction Model, Stamina 2.0/Optima was used to predict future noise levels for the design year 2015. All noise levels determined were the hourly equivalent sound levels ( $L_{eq}(h)$ ) in dBA. Methodology and the required input, including traffic volumes and 'speeds' associated with each alternate for each design section, are provided in the Noise Analysis Report supporting this EA.

Existing LOS "C" noise levels and future predicted LOS "C" noise levels are presented in Table 25. Existing values presented in the table are the worst-case levels at the measurement sites in each sensitive area. Noise levels for Alternates B and C represent the projected future worst-case noise levels at the analysis sites (Figures 10 through 17) in each sensitive area. It is assumed since LOS "C" volumes and speeds would be constant on the U.S. Route 29 mainline for a given Noise Sensitive Area, that impacts associated with the various concepts of Alternate C would be equivalent. The various concepts would have negligible effects as the U.S. Route 29 mainline is the main source contributor.

If existing roadways are operating at LOS "C" conditions and improvements are not implemented to increase capacity, then future predicted noise levels for the No Build Alternate (Alternate A) would remain the same as existing noise levels during LOS "C" operation. It is assumed that differences observed between measured existing and future predicted noise levels for Alternate A in Table 25 are a result of extraneous noise sources not associated with Route 29 operations.

Alternate B, involving roadway widening, would increase capacity on U.S. Route 29, which would result in a corresponding increase in noise for critical sensitive receptors. A critical sensitive receptor is defined as a first-row, ground-level site where the worst-case noise impact is found.

Alternate C improvements would result in the greatest increase in noise levels over the future Alternate A for LOS "C" operation. As with Alternate B, this increase in noise levels would be a result of an increase in capacity. With Alternate C, design improvements would result in a substantial increase in capacity; therefore, noise levels associated with Alternate C would represent the greatest increase over existing conditions.

Feasibility of noise abatement is considered when either of the following conditions occur:

1. Predicted  $L_{eq}(h)$  noise levels exceed the Noise Abatement Criteria for Activity Category B. Since all receptors are categorized as Activity Category B, the applicable noise level defining an impact is 67 dBA.
2. A significant increase in predicted noise levels over the existing noise levels may be experienced, even though the NAC level is not exceeded. A significant increase generally is considered to be 10



TABLE 25  
WORST-CASE PROJECTED NOISE LEVELS  
L<sub>eq</sub> (dBA)

AREA	DESCRIPTION	EXISTING	PROJECTED FUTURE NOISE LEVELS		
			ALT. A	ALT. B	ALT. C
A	Scaggs House	64	66	68	71
B	Hillcrest Heights/ Hammond Village	71(1)	70	72	75
C	Riverside Estates	66	68	69	72
D	Arrowhead	68(2)	66	67	70
E	River Meadows	70(3)	69	70	73
F	TOR Apartments/ Autumn Crest Apts./ Kelly's Store House	68	68	70	73
G	Guilford Downs	66	69	70	73
H	Columbia Hills	65	67	69	72

- (1) Heavy truck % were higher during measurement period than values used for predictive modeling.
- (2) Existing measurement influenced by traffic on Old Columbia Road. Heavy truck (HT) count was higher than modeled.
- (3) Medium trucks higher during measurement period. Background noise high due to construction activity.

146

dBa or greater, which represents a doubling of the perceived noise level or more. This criteria is not absolute. Noise level increases approaching 10 dBA may be considered for abatement as circumstances dictate.

None of the future noise levels for Alternates B or C would exceed existing noise levels by 10 or more dBA. However, 31 receptors would exceed or meet the NAC under Alternate B, and 66 receptors would exceed or meet the NAC under Alternate C. (Table 26).

Several of the Alternate C concepts modeled in the Noise Analysis Report were refined after the analysis was completed. Most notable were the modifications to Old Columbia Road under Concept VI-C-3, Hammond-Hillcrest under Concept VI-C-1, the new Concept VII-C-4 at Rivers Edge Road, and the new concepts developed at Seneca Drive in Segment VIII. These revised concepts were evaluated and found to produce no significant change to the results of the noise impact studies.

Where this impact analysis indicated that future noise levels would not comply with the FHWA NAC noise levels as a result of U.S. Route 29 improvements, methods of minimizing the noise impacts were evaluated. Naturally occurring earthen embankments, roadway cut sections, and ground alteration effects were utilized to evaluate future predicted noise levels. Where feasible, barriers were evaluated to reduce impacts associated with U.S. Route 29 improvements. Barrier heights from 11 to 26 feet were evaluated. A reduction of 7-10 dBA was used as the preliminary design goal to define the feasibility of the barrier system. Barrier cost was estimated using \$27.00/square foot. Generally, noise barriers are considered reasonable if the cost per residence is \$35,000 to \$40,000. All receptors receiving at least a 5 dBA benefit from the barrier system were included in the cost/residence analysis. If a 7 to 10 dBA reduction was not attainable at first-row locations, or is attainable at an unreasonably high cost, the barrier system was not considered feasible.

The effectiveness of Alternate B barrier schemes would be compromised by openings required to maintain access to local roadways in Noise Sensitive Areas B, C, F, G, and H. Many of the barrier designs for Alternate C would be more effective than Alternate B, where access openings are deleted as part of access control.

Mitigation of impacts associated with Alternates B and C were evaluated equally with respect to a reduction of 7 to 10 dBA to define feasibility of abatement even though unabated impacts for Alternate C are on the order of 3 dBA greater than corresponding Alternate B unabated noise levels for the same Noise Sensitive Area. Therefore, barriers to mitigate noise impacts for the two alternates will have approximately equivalent length, height, and cost requirements associated with achieving the minimum insertion loss design goal of 7 to 10 dBA at first-row receptors.

Table 27 presents the number of receptors and the level of reduction in noise levels at receptors in each Noise Sensitive Area for Alternates B and C with mitigation measures. As can be seen, 72 receptors would benefit from mitigation under Alternate B. A total of 112 receptors would benefit from mitigation under Alternate C.

Table 28 presents the barrier dimensions and associated costs for mitigation of noise impacts for Alternates B and C in each Noise Sensitive Area. The Noise

TABLE 26  
NUMBER OF RECEPTORS IMPACTED  
(NOISE LEVELS EXCEEDING NAC)

<u>NSA</u>	<u>ALTERNATE B</u>	<u>ALTERNATE C</u>
A	1	1
B	5	11
C	2	6
D	3	4
E	3	8
F	7	13
G	9	15
<u>H</u>	<u>1</u>	<u>8</u>
TOTAL	31	66

NOTE: The Noise Abatement Criteria is 67 dBA.

144

TABLE 27  
NUMBER OF RECEPTORS BENEFITING FROM NOISE BARRIERS

NSA	ALTERNATE B			ALTERNATE C(1)		
	7-10 dBA REDUCTION	>5 dBA REDUCTION	TOTAL	7-10 dBA REDUCTION	>5 dBA REDUCTION	TOTAL
A	1	-	1	1	-	1
B	1	2	3	5	6	11
C	2	7	9	6	9	15
D	5	4	9	7	6	13
E	2	2	4	2	5	7
F	16	3	19	19	6	25
G	11	6	17	16	10	26
<u>H</u>	<u>6</u>	<u>4</u>	<u>10</u>	<u>8</u>	<u>6</u>	<u>14</u>
TOTAL	44	28	72	64	48	112

(1) Alternate C quantities are presented for the most effective concept for noise control presented under Alternate C for the specific Noise Sensitive Area. In most cases, this would be a total control of access concept, devoid of any access for local roadways through the barrier.

TABLE 28  
NOISE BARRIER DIMENSIONS AND COSTS TO MITIGATE NOISE IMPACTS

NSA	ALTERNATE B				ALTERNATE C			
	LENGTH (FT)	HEIGHT (FT)	TOTAL COST (X\$1,000)	COST/RESIDENCE (X \$1,000)	LENGTH (FT)	HEIGHT (FT)	TOTAL COST (X\$1,000)	COST/RESIDENCE (X \$1,000)
A	1,000	16	214	214	1,000	16	214	214
B	2,600	21-16	1,966	655	2,600	16-21	1,430	130
C	3,900	16	1,666	185	3,900	16	1,991	133
D	850	16	401	45	1,500	16	648	50
E	2,000	21	1,196	299	2,000	21	1,372	196
F	4,800	16-26	2,714	143	4,800	16-26	2,830	113
G	3,700	21	2,155	127	3,700	16-21	2,329	90
H	1,820	21	629	63	1,870	16	802	57

IV-29

149

Analysis Report prepared to support this document provides further details regarding the location, sizing, and effectiveness of barriers in reducing noise impacts.

Construction noise differs from traffic noise in length, type, and duration of noise events. Construction noise is of a fixed duration, usually during daylight hours, and generally does not continue throughout the night. In addition, construction noise emanates from discontinuous noise sources, such as heavy machinery that produce varying levels of sound. Impacts resulting from construction are dependent upon the length of construction, equipment types, and the equipment usage cycle.

Typical construction would involve activities such as demolition, clearing and grubbing, earthwork, foundations, superstructures, paving operations, and finishing. Equipment used for these activities will be subject to Construction Noise Specifications to minimize impacts through control of the noise source, control along the sound path, and control at the receptor.

I. AIR QUALITY

The purpose of the air quality analysis was to determine the air quality impacts of the proposed alternatives in relationship to ambient air quality standards. Future air quality impacts for the project area were determined for the years 1995 and 2015 for each Alternate in Segments VI through X. Air quality modeling sites (Table 29) were established within Air Quality Sensitive Areas to represent residences and residential communities, offices, and historic sites (Figures 10 through 17). The U.S. Environmental Protection Agency's Mobile 3 model was utilized to predict emission factors. The range of speeds used in the model was 5 to 55 miles per hour. The California Department of Transportation's CALINE 3 dispersion model was employed to determine future carbon monoxide (CO) concentrations at the modeling sites. A wind speed of 1.0 meters/second, Stability Class 6 (F Stability), and temperature of 30° F was used for the analysis. The modeled CO values were added to projected background levels [3.6 parts per million (ppm) and 2.0 ppm for the 1 hour and 8 hour concentration, respectively, for 1995, and 3.5 ppm and 1.9 ppm for the 1 hour and 8 hour concentrations, respectively, for 2015] to calculate future impacts. Further details of the CALINE 3 model and its use in the Howard County study are contained in the Air Quality Technical Analysis Report.

The analysis indicates that in all cases Alternate A would result in the greatest air quality impacts and Alternate C would result in the least air quality impacts. Alternate B air quality impacts rank between Alternate A and C impacts. Differences in the impacts would result from improvements to traffic flow conditions under Alternates B and C. A lane addition in Alternate B would increase traffic speeds on U.S. Route 29, which would decrease CO emission rates. The access control improvements of Alternate C would further increase average speeds over Alternate B, and subsequently reduce emission rates and air quality impacts. There would be no substantial difference in air quality impacts among the various Alternate C concepts within each segment.

The National Ambient Air Quality Standards (NAAQS) for 1-hour average CO and 8-hour average CO are 35 and 9.0 parts per million, respectively. Table 30 presents the worst-case impacts among the various modeling sites for Alternates A, B, and C concepts for 1995 and 2015 in each Air Quality Sensitive Area. The Air Quality Technical Analysis Report, prepared to support this document,

TABLE 29  
AIR QUALITY MODELING SITES

<u>AIR QUALITY SENSITIVE AREA</u>	<u>MODELING SITE</u>	<u>DESCRIPTION OF MODELING SITE</u>
A	A-1	Scaggs House, residence
B	B-1	Hillcrest, residence
	B-2	Hammond Village, residence
C	C-1	Holiday Hills, residence
	C-2	Rivers Edge Road, residence
	C-3	Church of God State Headquarters, office
	C-4	Northbound U.S. Route 29, residence
D	D-1	Arrowhead, residence
	D-2	Seneca Drive, residence
E	E-1	River Meadows, residence
	E-2	Rosinate Run, residence
F	F-1	Talbott Springs Apartments
	F-2	Wandering Way, residence
	F-3	Kelly's Store House, historic/residence
	F-4	Gales-Gaither House, historic
	F-5	Felicity, historic/residence
G	G-1	Pepple Road, residence
	G-2	Pepple Road, residence
	G-3	West Pennfield Road, residence
	G-4	Diamondback Road, residence
	G-5	Dalton Drive, residence
H	H-1	West Hill Road, residence
	H-2	Spring Valley, residence

152

TABLE 30  
PROJECTED WORST-CASE CARBON MONOXIDE CONCENTRATIONS (PPM)

AIR QUALITY SENSITIVE AREA	YEAR	1-HOUR CO IMPACT (ppm)			8-HOUR CO IMPACT (ppm)		
		ALT A	ALT B	ALT C	ALT A	ALT B	ALT C
A	1995	3.8	3.7	3.7	2.1	2.1	2.1
	2015	10.2	5.6	3.6	4.0	2.6	2.0
B	1995	3.9	3.7	3.8	2.1	2.1	2.1
	2015	14.2	7.4	3.6	5.2	3.1	2.0
C	1995	10.2	8.9	3.7	6.1	5.6	2.1
	2015	13.6	13.4	4.2	7.9	8.0	2.4
D	1995	4.2	3.9	4.9*	2.3	2.2	3.2*
	2015	14.2	12.2	5.3*	6.5	5.6	3.3*
E	1995	7.8	7.1	3.7	4.1	3.7	2.1
	2015	10.1	10.2	3.6	5.1	5.1	2.0
F	1995	8.5	5.8	3.7	4.0	2.9	2.1
	2015	12.7	11.0	3.6	5.6	5.0	2.0
G	1995	10.1	6.6	3.7	4.6	3.2	2.1
	2015	16.0	14.2	3.7	6.2	5.4	2.0
H	1995	12.2	3.7	3.7	6.5	2.1	2.1
	2015	18.3	3.6	3.6	10.1	2.0	2.0

NOTE: The one-hour NAAQS is 30 ppm; the eight-hour NAAQS is 9 ppm.

\*The Alternate C concept which yielded the value was not modeled, but based on a similarly modeled concept, the impacts were estimated.



contains the projected CO impacts at each modeled site under Alternates A, B, and each C concept. A comparison of these worst case impacts against the NAAQS reveals that only one Air Quality Sensitive Area, Area H, would exceed the national standards. With no roadway improvements, Alternate A CO concentrations would exceed the 8-hour average level in the year 2015. This impact would be the result of high traffic volumes and low average operating speeds (15 and 20 mph) predicted for Segment X. Alternates B and C impacts modeled for this same area revealed reduced impacts as a result of improved traffic flow provided by additional lanes and the controlled access design features.

Several of the Alternate C concepts modeled in the Air Quality Technical Analysis Report were refined after the analysis was completed. Most notable were the modifications to Old Columbia Road under Concept VI-C-3 and 4, Hammond-Hillcrest Road under Concept VI-C-1, the new Concept VIII-C-4 at Rivers Edge Road, and the new concepts developed at Seneca Drive in Segment VIII. These revised concepts were evaluated and found to produce no significant change in results of the air quality studies.

This project is in an air quality maintenance area which has transportation control measures in the State Implementation Plan (SIP). This project conforms with the SIP since it is included in a conforming transportation improvement program.

The construction alternates, Alternate B and C, have the potential to impact ambient air quality through such means as fugitive dust from grading operations and materials handling. The State Highway Administration has addressed this possibility by establishing Specifications for Materials, Highways, Bridges, and Incidental Structures, which specifies procedures to be followed by contractors involved in state work.

The Maryland Bureau of Air Quality Control was consulted to determine the adequacy of the Specifications in terms of satisfying the requirement of the Regulations Governing the Control of Air Pollution in the State of Maryland. The Maryland Bureau of Air Quality Control found that the specifications are consistent with the requirements of these regulations. Therefore, during the construction period, all appropriate measures (Code of Maryland Regulations 10.18.06.02 D) will be taken to minimize the impact on the air quality of the area.

The Air Quality Technical Report will be sent to the Environmental Protection Agency and the Maryland Air Management Administration for review.

**A. PUBLIC INVOLVEMENT**

Public participation was an important part of the study, and thus was initiated early in the study process to allow incorporation of public concerns into the development of project alternates. An introductory review meeting was held on January 16, 1986, with representatives of the Howard County Office of Planning and Zoning. The purpose of the meeting was to review and comment on the various design options for Howard County. Issues of concern raised at this meeting include: a historical site near Johns Hopkins Road, flooding, and preference for certain design options.

The Alternates Public Workshop was held on February 8, 1986. This served as the first formal contact with the public. The purpose of the public workshop was to: acquaint interested persons with the project planning process, present findings of the engineering, environmental, and socioeconomic studies, and provide an opportunity for public involvement in the project planning process. The workshop offered a large number of individuals and groups the opportunity to express their opinions and concerns. Photogrammetric mapping depicting the various alternates were on display, with representatives available to answer questions and record comments. A brochure which highlighted key information and provided brief descriptions, maps, and typical sections of the alternates was distributed at the workshop. The public was encouraged to participate in the workshop to ensure their input in the decision-making process.

A debriefing meeting was then held on April 3, 1986, to determine which of the study alternates should be carried forward to further study based on the results of the workshop.

**B. AGENCY INVOLVEMENT**

In accordance with implementation procedures of the National Environmental Policy Act (NEPA), the following agencies were contacted to provide information or input in their particular discipline areas:

Howard County Office of Planning and Zoning, Department of Recreation and Parks

Howard County Public School System

Baltimore Regional Planning Council

U.S. Department of Agriculture, Soil Conservation Service

U.S. Department of Interior, Fish and Wildlife Service

Maryland State Health Department, Office of Environmental Programs

Maryland Department of Natural Resources

Washington Suburban Sanitary Commission

Howard County Department of Public Works, Bureau of Environmental Services

Maryland Historical Trust

A summary of all responses received through the coordination process is provided on the following pages. Copies of correspondence are included at the end of this section.

155

<u>AGENCY</u>	<u>RESPONSE</u>	<u>DATE OF RESPONSE</u>
Howard County Office of Planning and Zoning, Department of Recreation and Parks	Provided information on area parks.	May 26, 1986
Howard County Public School System	Provided information on schools with bus routes, attendance areas, and residence areas within the project corridor. Concern that limited access may impact bus routes of students along affected streets.	June 2, 1986
Baltimore Regional Planning Commission	Provided zonal mapping; and information on population, households, employment, auto ownership, age, race, and income.	April 29, 1986
Howard County Fire Department		
Ellicott City Fire Company 2		
Savage Volunteer Fire Company 9	Coordination letter was sent to local fire companies describing the project and requesting assistance in identifying potential project impacts and concerns. No responses have been received as of January, 1987.	
Johns Hopkins Applied Physics Laboratory Fire Department		
Maryland Assoc. of Bicycle Organizations	Expressed concern that improvements may limit bicycle access.	July 21, 1986
U.S. Department of Agriculture, Soil Conservation Service	Assisted in preparation of Farmland Conservation Impact Rating Form Results: total scores less than 160; minimal consideration for protection.	May 19, 1986
U.S. Department of Interior, Fish and Wildlife Service	No federally listed threatened or endangered species.	Jan. 25, 1985
	Wetlands field view. Provided input on significance of impact and mitigation suggestions. (Minutes located at end of this section.)	Oct. 1 & 20, 1986
Department of Natural Resources		
- Maryland Forest, Park and Wildlife Service	No threatened or endangered species.	Jan. 24, 1985

AGENCY

RESPONSE

DATE OF  
RESPONSE

Department of Natural Resources (Cont'd)

- Capital Programs Administration	No State or Federal endangered species. State-rare Walking Spleenwort found in Montgomery County.	Jan. 18, 1986
-----------------------------------	---	---------------

- Water Resources Administration	Waterway Construction Permit may be required for stream crossings. No in-stream work from: Oct-Apr for Class III streams, Mar-May for Class IV streams, Mar-June 15 for Class I streams.	May 27, 1986
----------------------------------	--	--------------

letter also contained concerns of:

Maryland Forest, Park and Wildlife Service	Concerned with potential impact on riverine wetlands.
--	---

Tidewater Administration, Coastal Resources Division	Provided classification of wetlands in project area. Recommend subjects to be covered in the EA.
--	--

- Water Resources Administration		May 28, 1986
----------------------------------	--	--------------

letter contained concerns of:

Natural Heritage Program of Capital Programs	Rare fish species found in Middle Patuxent. Two rare amphipods found in small streams adjacent to U.S. Route 29, south of U.S. Route 40. Recommends erosion control measures be strictly monitored to minimize impacts on wetlands.
--	---

- Water Resources Administration		June 20, 1986
----------------------------------	--	---------------

letter contained concerns of:

Tidewater Administration, Fisheries Division	<ol style="list-style-type: none"> <li>1) Expansion of existing highway preferred over new alignments.</li> <li>2) Full and rigorous enforcement of erosion control measures.</li> <li>3) Proposed work produce zero degradation of stormwater management.</li> <li>4) Concerned with runoff pollutants.</li> <li>5) Specific concerns on streams in Montgomery County.</li> </ol>
--	--

<u>AGENCY</u>	<u>RESPONSE</u>	<u>DATE OF RESPONSE</u>
Department of Natural Resources (Cont'd)		
- Tidewater Administration	Conducted site inspection of Hammond Branch and provided data sheets on water quality and fish and macroinvertebrate composition. Found Hammond Branch insufficient to support self-sustaining trout population; therefore, they wish to prevent further degradation.	August 7, 1986
- Tidewater Administration	Provided composition of macro-invertebrates and distribution of fish species by station for the Patuxent River watershed for 1980-1981.	August 11, 1986 (no letter provided.)
- Tidewater Administration	Provided fish distribution material for Patuxent River for 1966, 1967, and 1977. Comment that the cumulative effects of urbanization are severe, and additional effects can be expected with increased regional transportation capacity.	Sept. 9, 1986
- Maryland Geological Survey	Provided areas of archeological potential in the new right-of-way.	Nov. 13, 1985
- Maryland Geological Survey	Provided locations of two unconfirmed and one recorded archeological site for U.S. Route 29.	Oct. 21, 1985
- Maryland Geological Survey	No archeological sites were identified in the Phase I survey.	Dec. 23, 1986
- Water Resources Administration, Coastal Resources, Forest Parks and Wildlife Service, Fisheries Dept.	Wetlands field view. Provided input on significance of impact and mitigation suggestions. (Minutes located at the end of this section.)	Oct 1 & 20, 1986
Washington Suburban Sanitary Commission	Interested in project impacts on water quality and siltation in Rocky Gorge. Wish to review site plans and sediment control plans.	May 1, 1986
	(Asked for more specific information on park boundaries and uses. No response received as of January, 1987.)	

158

<u>AGENCY</u>	<u>RESPONSE</u>	<u>DATE OF RESPONSE</u>
Howard County Department of Public Works, Bureau of Environmental Services	Provided information from 208 Plan.	July 21, 1986 (no letter provided.)
Maryland Historical Trust	Concurrence in possible National Register eligibility and boundaries of twelve properties.	Aug. 20, 1986

**HOWARD COUNTY  
DEPARTMENT of RECREATION & PARKS**

GEORGE HOWARD BUILDING  
3430 COURT HOUSE DRIVE  
ELICOTT CITY, MARYLAND 21043  
(301) 992-2480  
TDD (301) 992-2323

159

William M. Mitchell  
Director

MAY 26 1986

**MEMORANDUM:**

DIVISION OF COMPREHENSIVE  
TRANSPORTATION PLANNING  
OF HOWARD COUNTY

**TO:** Ed Stollof  
**FROM:** Ed Stollof  
**SUBJECT:** U.S. Route 29 Improvements  
**DATE:** May 26, 1986

Attached are the Department's responses to Gannett-Fleming's request for information about the parks within the Route 29 corridor.

Other sources of information for parkland within the corridor would include the WSSC and the Columbia Association.

Please feel free to call if you need further information.

cc: William M. Mitchell

MES/db



**THE HOWARD COUNTY PUBLIC SCHOOL SYSTEM**

**10910 Route 108**

**Ellicott City, Maryland 21043-6198**

**(301) 992-0500**

**RECEIVED**

June 2, 1986

JUN 6 1986

Ms. Bettyann C. Bowers  
Environmental Manager  
Gannett Fleming  
Transportation Engineers, Inc.  
P. O. Box 1963  
Harrisburg, PA 17105

**GFC & C, INC.**

Re: U.S. Route 29 Improvements - Montgomery and Howard Counties

Dear Ms. Bowers:

Dr. John C. Murphy of the Board of Education asked me to respond to your recent letter concerning a request for input to the environmental study of the proposed improvements to U.S. Route 29 in Howard County. The answers to your questions and other related items are as follow:

1. Schools whose bus routes currently access school facilities using a left turn movement off or onto U.S. Route 29 at locations other than MD Routes 216, 32, 175, 108, 103, St. John's Lane, and Broken Land Parkway between MD Routes 32 and 175.

The remaining schools and locations other than those you identified are as follow:

<u>School</u>	<u>Location</u>
Hammond Elementary	Gorman Road
Atholton Elementary	Seneca Drive
Clemens Crossing Elementary	Owen Brown Road
Hammond Middle	Gorman Road
Clarksville Middle	Seneca Drive and Owen Brown Road
Atholton High	Gorman Road and Johns Hopkins Rd.
Hammond High	Gorman Road and Johns Hopkins Rd.
Oakland Mills High	Seneca Drive
Oakland Mills Middle	Seneca Drive
Northfield Elementary	Spring Valley Road
Dunloggin Middle	Spring Valley Road
Centennial High	Spring Valley Road

2. Schools whose attendance areas include both sides of U.S. Route 29:

Centennial High	Wilde Lake Middle
Mt. Hebron High	Clarksville Middle
Atholton High	St. John's Lane Elementary
Patapsco Middle	Northfield Elementary
Dunloggin Middle	Thunder Hill Elementary (beginning 1986-87)

**Hearing Impaired Number:  
TDD/TTY 992-4942**



161

Attached you will find a set of school attendance area maps for the current school year. You should keep in mind, however, that the attendance areas are subject to change on an annual basis. The maps should clarify your misinterpretation of "neighborhood schools." You might also be interested in knowing of the schools having pupils whose residences are actually located on U.S. Route 29. These schools are:

- |                           |                    |
|---------------------------|--------------------|
| Talbot Springs Elementary | Hammond Middle     |
| Atholton Elementary       | Centennial High    |
| Hammond Elementary        | Oakland Mills High |
| Dunloggin Middle          | Hammond High       |
| Clarksville Middle        |                    |

You also asked for our reaction to any adverse aspects relative to the proposed alternatives. If, in fact, access is only limited to the intersections noted, then the roads noted below will be without direct access. Students do, in fact, reside on these roads and adjacent streets, and while there may be alternate bus routes available, the alternate routes will be more expensive and time consuming.

<u>Road</u>	<u>Side of U.S. Route 29</u>
Old Columbia Pike	East and West
Hillcrest Drive	East
Hammond Drive	East
Gorman Road	East
Johns Hopkins Road	West
Rivers Edge Road	West
Seneca Drive	East
Allview Drive	East
River Meadow Drive	East
South Entrance Road	West
Columbia Road	East
Pepple Drive	East
Diamondback Road	East
Spring Valley Road	East
Columbia Road	West (exit only)

You will note that some areas may not have school bus route/stop access. We do have data concerning the exact number of students assigned to each school listed by home address. If you are interested in this information or if you need additional information, please feel free to contact Mr. Robert S. Lazarewicz, Director of Operations, at (301) 992-0500, extension 233.

Thank you for providing an opportunity to respond to this proposed project. I would appreciate receiving additional information related to the progress of this project.

Sincerely,

  
 Charles I. Ecker  
 Associate Superintendent  
 Finance and Operations

CIE/RSL/sas  
Attachments

cc: Board Members  
Mr. Hartmann  
Dr. Hickey  
Mr. Lazarewicz

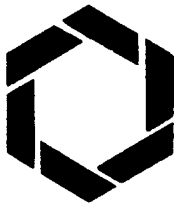

**Regional Planning Council**

2225 North Charles Street Baltimore, Maryland 21218-5767 (301) 554-5600  
George F. Harrison, Jr., *Chairman* Alfred P. Gwynn, *Executive Director*

162

April 29, 1986

**RECEIVED**

Ms. Betty Bowers  
Environmental Manager  
Gannett Fleming Transportation  
Enterprises, Inc.  
P. O. Box 1963  
Harrisburg, PA 17105

MAY 1 1986

**GFC & C, INC.**

Dear Ms. Bowers:

Per your written request for zonal information along the Howard County portion of the U.S. 29 corridor, I have enclosed the following:

- ° transportation zone map,
- ° zonal population, households, employment, and auto ownership for 1980, and for the forecast years of 1990 and 2005, and
- ° age, race, income information from the 1980 Census Urban Transportation Planning Package.

Please note that our agency currently is in the process of preparing revised zonal demographic data forecasts. I hope that these data satisfy your information needs.

If you have any questions, please do not hesitate to call me at (301)383-5845.

Sincerely,

Charles R. Goodman  
Assistant Director  
Transportation Division

CRG:sw  
Enclosures

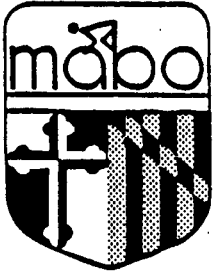

# maryland association of bicycle organizations

reply to: James M. Tordella  
President, MABO  
10353 Maypole Way  
Columbia, MD 21044

21 July 1985

Mr. Neil J. Pedersen, Director  
Office of Planning and Preliminary Engineering  
State Highway Administration  
Post Office Box 717  
Baltimore, MD 21203-0717

163  
**RECEIVED**

JUL 23 1985

#949

DIRECTOR, OFFICE OF  
PLANNING & PRELIMINARY ENGINEERING

Dear Mr. Pedersen:

[REDACTED] is vitally interested in the proposed improvement of U.S. Route 29 from I-495 to U.S. Route 40, as advertised in the paper. Many bicyclists in our member organizations live or work near U.S. 29. We all are concerned that the access we recently gained to U.S. 29 will be lost during some future upgrade of that road.

The Baltimore-Washington corridor contains no other roads which permit safe, efficient bicycle transportation in the corridor. Currently, only U.S. 29 is hospitable and legal for bicycles.

While a signed bike route does exist for part of the route, bicyclists require full access all along U.S. 29. South from MD Route 198, the bike path is usable, though often strewn with glass which must be periodically removed. The bike route crosses U.S. 29; this crossover capability must be maintained. Full bicycle access must be continued from the southern end of the bike route to the study limit, I-495.

North of MD Route 198 all the way through to the study limit, there is no possibility of bicycle transportation without using U.S. 29. We are concerned that at some future time bicyclists may be forbidden access to all or portions of this road, with no other alternative present. Limited river crossings and simple lack of any even remotely parallel roads require that bicycle transportation be provided for in your plan.

Interchanges constructed for U.S. 29 must also allow bicycle traffic to cross over U.S. 29 through wide curb lanes or separate structures conforming to AASHTO guidelines.

Bicycling is a cheap, highly efficient, and healthful way to commute. Bicycle commuting could relieve a noticeable amount of automobile traffic from U.S. 29, if it were provided for.

for better bicycling

Some are concerned for bicyclists' safety on the shoulders of divided highways. MABO notes that there have been no bicyclist fatalities since the recent enabling legislation was passed. I frequently ride on and commute to work on U.S. 29 and the new MD Route 32, and believe that route is vastly safer than old Md 32 and U.S. Route 1. People are being killed on those roads.

MABO believes that the Maryland Department of Transportation and the State Highway Administration have taken a large step forward in bicycle affairs through forming the MDOT Bicycle Advisory Committee. We look forward to working with you in that forum and in public hearings on U.S. 29.

Very truly yours,

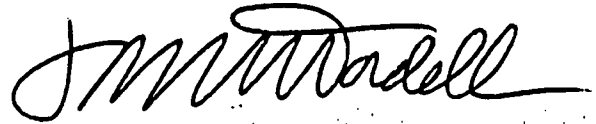

James M. Tordella  
President, MABO

cc: Howard County Council  
Columbia Council  
Michael Jackson, Bicycle Coordinator, D.C. DOT



United States  
Department of  
Agriculture

Soil  
Conservation  
Service

10 W. College Terrace  
Room 230  
Frederick, Maryland 21701

165

May 19, 1986

RECEIVED

MAY 21 1986

GFC & C, INC.

Ms. Betty Bowers  
Environmental Manager  
Gannett Fleming Transportation Engineers, Inc.  
P.O. Box 1963  
Harrisburg, PA 17105

Re: Farmland Conversion Impact Rating Form (AD-1006) for U.S. Rt. 29  
Improvements, Montgomery and Howard Counties, MD.

Dear Ms. Bowers:

Attached are AD-1006 forms covering only those alternative segments of the project which contained lands that qualify as prime or statewide important under the guidelines of the FPPA act. Separate forms were used for each county since our land evaluation systems are prepared on an individual county basis. Acreages of prime and statewide important soils are not precise due to difficulties in transferring soil mapping to the small scale plan maps provided in the package.

For clarification purposes, I will point out that percentages in Part II are based on the total land area in the respective county, and in Part IV.D. percentage is based on total farmland as defined in FPPA.

If I can be of further assistance, please contact me at 301 - 694-6822 in Frederick, Maryland.

Sincerely,

*Carl E. Robinette*

CARL E. ROBINETTE  
Area Soil Scientist

Enclosures

cc:  
Rick Brush, District Conservationist, SCS, Rockville, MD  
Jack Helm, District Conservationist, SCS, Ellicott City, MD



The Soil Conservation Service  
is an agency of the  
Department of Agriculture

U.S. Department of Agriculture

**FARMLAND CONVERSION IMPACT RATING**

**PART I (To be completed by Federal Agency)** Date Of Land Evaluation Request **4-4-86**

Name Of Project **U.S. Route 29 Improvements** Federal Agency Involved **State Highway Administration**

Proposed Land Use **See attached** County And State **Howard County, MD**

**PART II (To be completed by SCS)** Date Request Received By SCS **4-10-86**

Does the site contain prime, unique, statewide or local important farmland? (If no, the FPPA does not apply - do not complete additional parts of this form). Yes  No  Acres Irrigated **None** Average Farm Size **117**

Major Crop(s) <b>Corn, Small Grain, Soybeans, Hay</b>	Farmable Land In Govt. Jurisdiction Acres: <b>86,200</b> % <b>54</b>	Amount Of Farmland As Defined in FPPA Acres: <b>70,600</b> % <b>44</b>
Name Of Land Evaluation System Used <b>Howard Co. LESA</b>	Name Of Local Site Assessment System <b>Howard Co. LESA System</b>	Date Land Evaluation Returned By SCS <b>5/16/86</b>

	Alternative Site Rating *			
	Site A	Site B	Site C	Site D
A. Total Acres To Be Converted Directly	<b>96 maximum</b>			
B. Total Acres To Be Converted Indirectly	<b>0</b>			
C. Total Acres In Site	<b>96 maximum</b>			

**PART IV (To be completed by SCS) Land Evaluation Information**

	Site A	Site B	Site C	Site D
A. Total Acres Prime And Unique Farmland	<b>6</b>	<b>1</b>		
B. Total Acres Statewide And Local Important Farmland	<b>0</b>	<b>1</b>		
C. Percentage Of Farmland In County Or Local Govt. Unit To Be Converted	<b>.008</b>	<b>.003</b>		
D. Percentage Of Farmland In Govt. Jurisdiction With Same Or Higher Relative Value	<b>66.3</b>	<b>86.8</b>		

**PART V (To be completed by SCS) Land Evaluation Criterion**

Relative Value Of Farmland To Be Converted (Scale of 0 to 100 Points)	Site A	Site B	Site C	Site D
	<b>72</b>	<b>57</b>		

**PART VI (To be completed by Federal Agency)**

Site Assessment Criteria (These criteria are explained in 7 CFR 658.5(b))	Maximum Points	Site A	Site B	Site C	Site D
1. Area In Nonurban Use					
2. Perimeter In Nonurban Use					
3. Percent Of Site Being Farmed					
4. Protection Provided By State And Local Government					
5. Distance From Urban Builtup Area					
6. Distance To Urban Support Services					
7. Size Of Present Farm Unit Compared To Average					
8. Creation Of Nonfarmable Farmland					
9. Availability Of Farm Support Services					
10. On-Farm Investments					
11. Effects Of Conversion On Farm Support Services					
12. Compatibility With Existing Agricultural Use					
<b>TOTAL SITE ASSESSMENT POINTS</b>	<b>160</b>	<b>56</b>	<b>48</b>		

**PART VII (To be completed by Federal Agency)**

	Site A	Site B	Site C	Site D
Relative Value Of Farmland (From Part V)	<b>100</b>	<b>72</b>	<b>57</b>	
Total Site Assessment (From Part VI above or a local site assessment)	<b>160</b>	<b>56</b>	<b>48</b>	
<b>TOTAL POINTS (Total of above 2 lines)</b>	<b>260</b>	<b>128</b>	<b>105</b>	

Site Selected: \_\_\_\_\_ Date Of Selection \_\_\_\_\_ Was A Local Site Assessment Used? Yes  No

Reason For Selection:  
\* Site A = VI-C-2; B = VI-C-3

167

HOWARD COUNTY LESA

Site Assessment Criteria

	<u>Maximum Points</u>	<u>Site A VI-C-2</u>	<u>Site B VI-C-3</u>
A. Percent of Area in Agriculture Within One Mile	5	1.25	1.25
B. Land in Agriculture Adjacent to Site	10	0	0
C. Protected Land Contiguous to Site	10	0	0
D. Size of Site	10	3.0	0
E. Percent of Site That Can Be Economically Farmed	5	5	5
F. Ownership and Operation	7	7 assume maximum*	7
G. Land Management	-10	0	0
H. Capital Investment in Permanent Buildings and Land Improvements	5	0	0
I. Actual Land Use	<u>5</u>	<u>3.75</u>	<u>3.75</u>
TOTAL SITE ASSESSMENT POINTS	57	20	17
ADJUSTED CATEGORY POINTS (Based on 200 points for Howard Co. LESA)	200	70	60
ADJUSTED POINTS FOR FORM AD-1006 (Based on 160 points)	160	56	48

\*No basis for answer, therefore, maximum assumed.

166

HOWARD COUNTY LESA  
 SITE ASSESSMENT CRITERIA  
 FOR  
 CONCEPT VI-C-1 AT HOPKINS-GORMAN ROAD  
 (ADDED AFTER COORDINATION WITH SCS)

	<u>Maximum Points</u>	<u>VI-C-1 at Hopkins-Gorman Road</u>
A. Percent of Area in Agriculture Within One Mile	5	1.25
B. Land in Agriculture Adjacent to Site	10	0
C. Protected Land Contiguous to Site	10	0
D. Size of Site	10	3
E. Percent of Site That Can Be Economically Farmed	5	5
F. Ownership and Operation	7	7*
G. Land Management	-10	0
H. Capital Investment in Permanent Buildings and Land Improvements	5	0
I. Actual Land Use	<u>5</u>	<u>3.75</u>
TOTAL SITE ASSESSMENT POINTS	57	20
ADJUSTED CATEGORY POINTS (Based on 200 points for Howard County LESA)	200	60
ADJUSTED POINTS FOR FORM AD-1006 (Based on 160 points)	160	56

\*No basis for answer; therefore maximum assumed.





# United States Department of the Interior

FISH AND WILDLIFE SERVICE  
DIVISION OF ECOLOGICAL SERVICES  
1825B VIRGINIA STREET  
ANNAPOLIS, MARYLAND 21401

January 25, 1985

Ms. Cynthia D. Simpson  
Environmental Management  
State Highway Administration  
P.O. Box 717  
707 N. Calvert St.  
Baltimore, MD 21203

Dear Ms. Simpson:

This responds to your January 8, 1985, request for information on the presence of Federally listed endangered or threatened species within the area of U.S. Route 29, from I-495 in Montgomery County to U.S. Route 40 in Howard County, Maryland (P.D.M.S. No. 132046).

Except for occasional transient individuals, no Federally listed or proposed endangered or threatened species are known to exist in the project impact area. Therefore, no Biological Assessment or further Section 7 Consultation is required with the Fish and Wildlife Service (FWS). Should project plans change, or if additional information on the distribution of listed or proposed species becomes available, this determination may be reconsidered.

This response relates only to endangered species under our jurisdiction. It does not address other FWS concerns under the Fish and Wildlife Coordination Act or other legislation.

Thank you for your interest in endangered species. If you have any questions or need further assistance, please contact Andy Moser of our Endangered Species staff at (301) 269-6324.

Sincerely yours,

*S. A. Kinser*

Glenn Kinser  
Supervisor  
Annapolis Field Office



170

DEPARTMENT OF NATURAL RESOURCES  
Maryland Forest, Park & Wildlife Service

TORREY C. BROWN, M.D.  
SECRETARY

TAWES OFFICE BUILDING  
ANNAPOLIS, MARYLAND 21401

DONALD E. MacLAUCHLAN  
DIRECTOR

January 24, 1985

Cynthia D. Simpson  
Environmental Management  
Maryland Department of Transportation  
P.O. Box 717  
707 North Calvert Street  
Baltimore, MD 21203-0717

RE: Contract No. HO-606-151-770  
U.S. Rt. 29 from I-495 in  
Montgomery Co. to U.S. Rt. 40  
in Howard Co. P.D.M.S.No.132046  
Contract No. AW 787-106-012 N  
Md. Routes 194 and 26 Intersection  
Reconstruction

Dear Ms. Simpson:

Your request for any information we may have concerning threatened or endangered species was reviewed by Gary J. Taylor.

There are no known populations of listed threatened or endangered species within the areas of project influence for the proposed intersection reconstruction of MD routes 194 and 26 (Contract No. AW 787-106-012 N); or the proposed improvements to U.S. route 29 from I-495 to U.S. route 40 (Contract No. HO 606-151-770).

Sincerely,

James Burtis, Jr.  
Assistant Director

JB:emp

cc: G. Taylor  
C. Brunori

JAN 27 1985



171

TORREY C. BROWN, M.D.  
SECRETARY  
JOHN R. GRIFFIN  
DEPUTY SECRETARY

STATE OF MARYLAND  
DEPARTMENT OF NATURAL RESOURCES  
**CAPITAL PROGRAMS ADMINISTRATION**  
TAWES STATE OFFICE BUILDING  
ANNAPOLIS, MARYLAND 21401

FRED L. ESKEW  
ASSISTANT SECRETARY  
FOR CAPITAL PROGRAMS

January 18, 1985

Mr. Louis H. Ege, Jr.  
Bureau of Project Planning  
State Highway Administration  
707 North Calvert Street  
Baltimore, Maryland 21203

Subject: Improvements to U.S. Route 29, from I-495 in  
Montgomery County to U.S. Route 40 in Howard County  
Contract No. HO 606-151-770

Dear Mr. Ege:

The Heritage Program has no record of any species presently included on the State or Federal Endangered Species lists occurring along this portion of U.S. Route 29. There is, however, a historic record for the state-rare Walking Spleenwort (*Asplenosorus ebenoides*), observed in 1937 on the "old highway bridge over Point Branch." I recommend that this bridge be examined to determine if the Walking Spleenwort is still present, before improvements are implemented. If I can be of further assistance, please do not hesitate to contact me.

Sincerely,

Arnold W. Norden  
Maryland Natural Heritage Program

AWN:mle

TORREY C. BROWN, M.D.  
SECRETARY

JOHN R. GRIFFIN  
DEPUTY SECRETARY



172  
JAMES W. PECK  
DIRECTOR

RECEIVED

JUN 2 1986

STATE OF MARYLAND  
DEPARTMENT OF NATURAL RESOURCES  
**WATER RESOURCES ADMINISTRATION**

TAWES STATE OFFICE BUILDING  
ANNAPOLIS, MARYLAND 21401

GFC & C, INC.

May 27, 1986

Ms. Betty Bowers  
Environmental Manager  
Gannett Fleming Transportation  
Engineers, Inc.  
P. O. Box 1963  
Harrisburg, PA 17105

Re: WRA File No. 86-PP-0900  
US Route 29 Improvements  
Montgomery and Howard  
Counties, Maryland

Dear Ms. Bowers:

The Administration has made a preliminary review of the submittal (your letter of April 18, 1986, location map and Water Resources map) for the above referenced project. The aforementioned submittal has also been sent to other Agencies within the Department of Natural Resources for their review and comments. The following is a summary of the comments from this office, the Maryland Forest, Park and Wildlife Service and the Coastal Resources Division of the Tidewater Administration:

As you have indicated in your letter that US 29 crosses over three drainage sub-basins and will include 43 stream crossings, a Waterway Construction Permit must be obtained from this office for each one of the crossings to be affected by the proposed improvements and provided that any changes to the course, current, or cross-section of the channel or its floodplain exceeds 100 acres for the natural and recreational trout waters, or 400 acres for all other waters, except those areas delineated as having a special flood hazard by the Federal Insurance Administration.

In addition, no in-stream work will be allowed from October through April, inclusive, for the streams classified as Class III Natural Trout Waters. The in-stream work will be prohibited from March through May, inclusive, for Class IV Recreational Trout Waters and from March through June 15, inclusive, for all Class I Waters.

The primary concerns of the Maryland Forest, Park and Wildlife Service (MFPWS) are the various river crossings associated with the subject improvements and their potential impact on riverine wetlands. The MFPWS would like to be kept abreast of project planning and different stages as it progresses.

Telephone: (301) 269-2265

V-19

Ms. Betty Bowers  
May 27, 1986  
Page Two

A general outline of the types of non-tidal wetlands that presently exist in the US 29 corridor is listed below. Preliminary analysis of the National Wetland Inventory Maps by the Tidewater Administration's Coastal Resources Division revealed that there are more than 17 small wetlands in the project area:

Kensington Quad

- R30WH - Upper perennial riverine, open water permanently flooded.
- POWZh - Palustrine open water, impounded, intermittently exposed and permanently flooded.

Beltsville Quad

- R30WH - Upper perennial riverine, open water, permanently flooded.
- PF01A - Palustrine forested, temporarily flooded, broad-leaved deciduous vegetation.
- POWZh - Palustrine open water, impounded, intermittently exposed and permanently flooded.

Clarksville Quad

- PF01A - Palustrine forested temporarily flooded, broad-leaved deciduous vegetation.
- R20WH - Riverine, lower perennial, open water, permanently flooded.

Savage Quad

- PF01A - Palustrine forested, temporarily flooded, broad-leaved deciduous vegetation.
- R20WH - Riverine, lower perennial, open water, permanently flooded.
- PEM5A - Palustrine, emergent, temporarily flooded, narrow-leaved persistent vegetation.
- P SS1A - Palustrine scrub/shrub (broad-leaved deciduous) - EM5 emergent (narrow-leaved persistent), temporarily flooded.

Ms. Betty Bowers  
May 27, 1986  
Page Three

174

Ellicott City Quad

PF01A - Palustrine forested, temporarily flooded, broad-leaved deciduous vegetation.

P SS1A - Palustrine scrub/shrub (broad-leaved deciduous) -  
EM5 emergent (narrow-leaved persistent), temporarily flooded.

The Coastal Resources Division recommends the following information to be covered in the environmental assessment:

1. Field - identified data on the vegetative species including dominant, understory, and herbaceous plant types;
2. Soils characteristics of the wetlands, including hydrologic regime (e.g. temporary, saturated, seasonal, permanent, etc.) and drainage class (e.g. poorly drained, very poorly drained);
3. Wetlands acreage impacted, by type;
4. Aquatic and terrestrial wildlife in the project area;
5. Benthic invertebrates inhabiting the streams or rivers;
6. Details of proposed mitigation for wetland impacts; and
7. Wetland boundary delineation performed in the field and flagged with bright plastic ribbon and provided on map of the project.

Please keep in mind that additional comments are forthcoming from the Tidewater Administration's Fisheries Division and Capital Programs' Natural Heritage Section. Their comments will be forwarded to you as they become available.

If you have any questions regarding the above matters, please contact me at (301) 269-2265.

Sincerely,



M. Q. Taherian  
Project Engineer  
Waterway Permits Division

MQT:das

cc: C. Simpson, SHA  
R. Aldrich, SHA

TORREY C. BROWN, M.D.  
SECRETARY  
JOHN R. GRIFFIN  
DEPUTY SECRETARY



STATE OF MARYLAND  
DEPARTMENT OF NATURAL RESOURCES  
**WATER RESOURCES ADMINISTRATION**  
TAWES STATE OFFICE BUILDING  
ANNAPOLIS, MARYLAND 21401

175  
JAMES W. PECK  
DIRECTOR

RECEIVED

JUN 2 1986

GFC & C, INC.

May 28, 1986

Ms. Betty Bowers  
Environmental Manager  
Gannett Fleming Transportation  
Engineers, Inc.  
P. O. Box 1963  
Harrisburg, PA 17105

Re: WRA File No. 86-PP-0900  
US Route 29 Improvements  
Montgomery and Howard  
Counties, Maryland

Dear Ms. Bowers:

As a follow-up to my letter dated May 27, 1986, providing you with a summary of review and recommendations of this office and other Agencies of the Department of Natural Resources, the following are the comments received this date from the Natural Heritage Program of Capital Programs on the project's impact on numerous wetlands and rare species:

Etheostoma vitreum (Glassy Darter)

This rare fish species is found in the middle Patuxent River at the Route 29 crossing. Any siltation or substrate alteration at this site would impact this population. Additionally, the impact of any major bridge alteration at this site could be devastating to this population.

Stygobromus t. potomacus  
Stygobromus pizzinii rare invertebrates (amphipodidae)

These rare amphipods are found in a few small streams adjacent to Route 29 just south of its intersection with Route 40, in the area between Rolling Acres and Greencastle Road (U.S.G.S. Beltsville Quad). Stygobromus sp. are very sensitive to water quality changes, and would be impacted by runoff from highway construction.

(301) 269-2265

Telephone: \_\_\_\_\_

V-22

174

Ms. Betty Bowers  
May 28, 1986  
Page Two

In addition to the above areas, the Heritage Program recommends that erosion control measures be carefully applied and strictly monitored, maintained and enforced to minimize impact on wetlands adjacent to construction. Capital Programs would like to be kept up-to-date especially if there would be any changes on the planning or design.

If you have any questions regarding the above matters, please contact me at (301) 269-2265.

Sincerely,

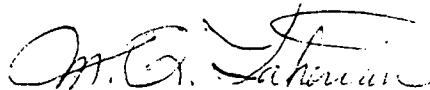

M. Q. Taherian  
Project Engineer  
Waterway Permits Division

MQT:das

cc: C. Simpson, SHA  
R. Aldrich, SHA



TORREY C. BROWN, M.D.  
SECRETARY  
JOHN R. GRIFFIN  
DEPUTY SECRETARY



177  
JAMES W. PECK  
DIRECTOR

RECEIVED

JUN 23 1986

GFC & C, INC.

STATE OF MARYLAND  
DEPARTMENT OF NATURAL RESOURCES  
**WATER RESOURCES ADMINISTRATION**  
TAWES STATE OFFICE BUILDING  
ANNAPOLIS, MARYLAND 21401

June 20, 1986

Ms. Betty Bowers  
Environmental Manager  
Gannett Fleming Transportation  
Engineers, Inc.  
P. O. Box 1963  
Harrisburg, PA 17105

Re: WRA File No. 86-PP-0900  
US Route 29 Improvements  
Montgomery and Howard  
Counties, Maryland

Dear Ms. Bowers:

The following are the comments received on June 18, 1986 from the Tidewater Administration's Fisheries Division on the above referenced project:

1. All the alternates being considered by SHA as part of its proposal involve improvements and expansion of an existing alignment. Generally speaking, Fisheries Division believes that if expansion of transportation facilities must be achieved it is preferable to expand an existing highway rather than penetrating relatively undisturbed areas with new alignments.
2. Full and rigorous implementation and enforcement of erosion and sediment control measures during the construction stage is assumed. Appropriate standards and specifications are SHA's own "Standard Erosion and Sediment Control Procedures" as well as WRA standards and specifications.
3. We are concerned about stormwater management and we expect full application of COMAR 05.08.05.05. There will be increases in imperious surface and traffic-induced polluted runoff. Fisheries Division insists that the proposed work produce zero additional degradation from stormwater management operations.
4. Improving I-29 in the project area will facilitate and accelerate the already rapid rate of development and suburbanization. This in turn will increase imperious surface, accelerate discharges of

Telephone: (301) 269-2265

V-24

178

Ms. Betty Bowers  
June 20, 1986  
Page Two

polluted runoff and increase the already serious problem of stream channel erosion and sedimentation. Past Fisheries Division attempts to raise this problem of "secondary effects" have never drawn much SHA response. Nevertheless, we continue to make the point for the record and for consistency.

5. Aside from the broad aspects touched on in items (1) through (4) above, Fisheries Division's specific concerns center around the three stream crossings in the subject Route I-29 highway segment. These are Northwest Branch, Paint Branch and an unnamed tributary to Little Paint Branch, whose situations are discussed separately below.
6. Northwest Branch Crossing: Route I-29 presently crosses Northwest Branch over a bridge that now accommodates six lanes of traffic - as much as is contemplated under any of the alternatives under consideration. Based on the information made available to us (SHA brochure for March 1, 1986, Alternatives Public Workshop), there appear to be no plans to alter this stream crossing in any major way. If this conclusion is in error we would like to be informed. There could be serious fisheries habitat concerns. Stormwater runoff (with its cargo of highway pollutants) enters directly into the stream at the bridge. Any upgrading of the highway should address this situation. Northwest Branch is Class IV (recreational trout) water. Stocking of trout is conducted in Northwest Branch, mostly just below (and upstream of) the Randolph Road crossing. Some of the stocked trout occasionally make their way down to the I-29 crossing, although this means traversing a concrete dam (with its fully-silted impoundment) located just upstream of I-29.
7. Paint Branch Crossing: Route I-29 crosses Paint Branch over a split, double bridge presently accommodating four lanes of traffic, as does most of I-95 north of New Hampshire Avenue. While not spelled out in the material made available to us, it appears that the wide median strip would be ample to accommodate six lanes without widening the basic highway alignment. However, the median strip does not get carried across the existing bridge. Thus, expansion to six lanes would involve substantial alteration and reconstruction of the bridge with the possibility of significant disruption to the stream habitat below. This problem will have to be addressed at the appropriate stage in the planning process. Stormwater runoff (with its cargo of highway pollutants) enters directly into the stream in the general vicinity of the bridge. Any upgrading of the highway or alteration of the existing bridge should address this problem - preferably by providing infiltration options for stormwater runoff from the highway.

179

Ms. Betty Bowers  
June 20, 1986  
Page Three

Paint Branch is Class III (naturally reproducing) trout water and the overall ecosystem supports a naturally-reproducing brown trout fishery with no stocking. Spawning has not been documented in the vicinity of the I-29 bridge crossing; it tends to be concentrated in the extreme upper Paint Branch ecosystem, especially the Good Hope tributary. However, adult brown trout up to 14 inches in length are regularly found in the stream in the vicinity of the bridge, both by trout fishermen and by DNR electrofishing (per comm. Charles Gougeon, Coldwater Fisheries Program). Acutually adult brown trout have made their way down Paint Branch all the way to the I-495 Beltway. The Paint Branch crossing represents very valuable and very fragile fisheries habitat. It warrants the utmost in protection by maximized BMP's to offset any possible disruption from highway upgrading.

I trust the above comments will provide you with essential input in preparation of your preliminary engineering and environmental studies for the proposed improvements of US 29.

If you should have any questions regarding the above matters, please contact me at (301) 269-2265.

Sincerely,



M. Q. Taherian  
Project Engineer  
Waterway Permits Division

MQT:das

RECEIVED

180 AUG 11 1986

GFC & C, INC.

JOHN R. GRIFFIN  
DEPUTY SECRETARY



TORREY C. BROWN, M.D.  
SECRETARY

STATE OF MARYLAND  
DEPARTMENT OF NATURAL RESOURCES  
**TIDEWATER ADMINISTRATION**  
TAWES STATE OFFICE BUILDING  
ANNAPOLIS 21401

August 7, 1986

Gannett-Fleming Company  
Attention Dave Willis  
P.O. Box 1963  
Harrisburg, PA 17105

re: fish survey data for streams along  
the Route 29 corridor in Howard and  
Montgomery Counties, Maryland.

Dear Mr. Willis:

I have searched my files for fish data on those streams that may be impacted by construction activities generated by the MD Route 29 widening project. In addition, my associate Greg Golden and myself conducted site inspections on four streams where fish data was lacking, in order to assess their trout fishery potential. Our site inspections were conducted on July 25, 1986, on the following streams: 1) Hammond Branch; 2) Red Hill Branch; 3) Tiber Branch; and 4) Hudson Branch. It should be noted that these streams were investigated in the past by Coldwater Fisheries personnel, and all were dismissed as potential candidates for self-sustaining trout populations.

Generally, the same conclusions were made of these streams following our site inspections. Data sheets with data/comments have been included for Hammond Branch and Red Hill Branch. The other streams were judged to be poor for trout survival based on habitat, water temperature, watershed characteristics and degree of sedimentation. In site of our findings that all four streams are insufficient to support self-sustaining trout populations, it is our responsibility to prevent further degradation of the waters of the state whenever possible.

Notes and references to Northwest Branch and Paint Branch are as follows:

Northwest Branch - According to our records, Northwest Branch has received annual stockings of hatchery reared trout since the spring of 1977 as part of the state's programs designed to provide recreational trout fishing to residents of the Washington-Metro area. The State of Maryland, Department of Natural Resources (DNR) currently plans to continue this trout stocking practice each spring between the months of March and the middle of May, downstream of Route 29 at the following locations: 1) Adelphi Mill bike path (Route 212, Riggs Road) and 2) immediately upstream and downstream of Univer-Boulevard (Route 193).

181

Fisheries will recommend that all construction activities be planned around the non-construction dates for Northwest Branch (Class IV streams, Recreational trout waters) as determined by the Water Resources Administration (WRA) of the State of Maryland.

Paint Branch -

Please find enclosed a copy of our most recent Federal Aid report (F-36-R). Paint Branch is our most sensitive stream segment with respect to the proposed Route 29 construction as it holds the only self-sustaining trout population in all of Montgomery County.

Fisheries will recommend that all construction activities be planned around the non-construction dates for Paint Branch (Class III stream, Natural Trout Waters) as determined by WRA.

A self-sustaining brown trout population has been documented in Paint Branch from its headwaters downstream to the capital beltway Route 495. All precautions must be taken to prevent further degradation/impact to the fishery downstream of the Route 29 bridge during the construction phase.

If you should need any additional information, please feel free to contact me at my office at Phone: 301 854-6060 or 301 442-2080.

Sincerely,

*Charles R. Gougeon*

Charles R. Gougeon  
DNR Biologist  
Tidewater Administration

17400 Annapolis Rock Rd.  
Woodbine, MD 21797

ajh.

RECEIVED

SEP 12 1986

142

GFC & C, INC.

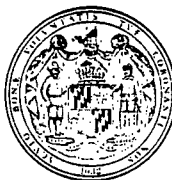

TORREY C. BROWN, M.D.  
SECRETARY

JOHN R. GRIFFIN  
DEPUTY SECRETARY

STATE OF MARYLAND  
DEPARTMENT OF NATURAL RESOURCES  
**TIDEWATER ADMINISTRATION**  
TAWES STATE OFFICE BUILDING  
ANNAPOLIS 21401

September 9, 1986

Gannett Fleming  
PO Box 1963  
Harrisburg, Pennsylvania 17105  
Attention: Nancy Eagle

Dear Ms. Eagle,

Enclosed is fish distribution material which you requested for the Patapsco and Patuxent Rivers in connection with the environmental statements for the upgrading of U.S. Rt. 29. I regret that I have been unable to find the expected material for the upper Anacostia, however, it should be similar, with the caveat that the Paint Branch tributary contains reproducing brown trout. Other portions of the upper Anacostia have been degraded somewhat due to urbanization; otherwise they would exhibit a normal piedmont fish fauna.

I would strongly suggest that your firm commission a survey of the areas in question, as urbanization related cumulative effects are severe throughout the three drainages and should be discussed in the environmental assessments, with evaluations of the additional effects to be expected with increased regional transportation capacity.

Sincerely,

W.R. Carter III

enclosures

WRC/cp



183

TORREY C. BROWN, M.D.  
SECRETARY

JOHN R. GRIFFIN  
DEPUTY SECRETARY

STATE OF MARYLAND  
DEPARTMENT OF NATURAL RESOURCES  
MARYLAND GEOLOGICAL SURVEY

THE ROTUNDA  
711 W. 40TH STREET, SUITE 440  
BALTIMORE, MARYLAND 21211

KENNETH N. WEAVER  
DIRECTOR  
MARYLAND GEOLOGICAL SURVEY

EMERY T. CLEAVES  
DEPUTY DIRECTOR

13 November 1985  
Division of Archeology

Ms. Rita Suffness  
Environmental Management Office  
Bureau of Project Planning  
State Highway Administration  
Room 314  
707 N. Calvert Street  
Baltimore, MD 21202

Re: US 29 (I-495 to Howard Co.)

Dear Rita:

I have indicated in red on the attached maps those portions of the subject project requiring new right-of-way that possess moderate to high archeological potential. They are all centered near the Maryland Route 198/U.S. Route 29 intersection, where a number of flats overlook headwater tributaries. These settings are similar to that of site 18MC47, a large multi-component site spanning the period from circa 6300 BC to AD 1600 (see my 1977 report on MD 198).

The remainder of the new right-of-way areas are considered to have moderate to low (mostly low) archeological potential. This is due primarily to suburbanization, prior disturbance, slope, and the limited extent of new right-of-way required.

If I can be of further assistance, please let me know.

Sincerely yours,

Dennis C. Curry  
Archeologist

29  
358  
184



TORREY C. BROWN, M.D.  
SECRETARY

JOHN R. GRIFFIN  
DEPUTY SECRETARY

STATE OF MARYLAND  
DEPARTMENT OF NATURAL RESOURCES  
MARYLAND GEOLOGICAL SURVEY

THE ROTUNDA  
711 W. 40TH STREET, SUITE 440  
BALTIMORE, MARYLAND 21211

KENNETH N. WEAVER  
DIRECTOR  
MARYLAND GEOLOGICAL SURVEY  
EMERY T. CLEAVES  
DEPUTY DIRECTOR

21 October 1985  
Division of Archeology

Rita Suffness  
Environmental Management Office  
Bureau of Project Planning  
State Highway Administration  
Room 314  
707 N. Calvert Street  
Baltimore, Md 21202

Re: US. Route 29  
MD Route 358 Extended N...

Dear Rita:

I have reviewed our sites files for the two subject projects. There are no sites recorded in or near the Maryland Route 358 (Extended) project in Somerset County.

For the U.S. Route 29 project, I have attached two maps showing the locations of two reported sites (unconfirmed) and one recorded site (18H079). There are no descriptions of the two reported sites, although they are probably prehistoric lithic scatters based on the name of the person who reported them. Site 18H079 is a late 18<sup>th</sup>-20<sup>th</sup> century site and possibly corresponds to MHT inventory #H087.

Let me know if I can be of further assistance.

Sincerely,

Dennis C. Curry  
Archeologist



165



TORREY C. BROWN, M.D.  
SECRETARY

JOHN R. GRIFFIN  
DEPUTY SECRETARY

KENNETH N. WEAVER  
DIRECTOR  
MARYLAND GEOLOGICAL SURVEY  
EMERY T. CLEAVES  
DEPUTY DIRECTOR

STATE OF MARYLAND  
DEPARTMENT OF NATURAL RESOURCES  
**MARYLAND GEOLOGICAL SURVEY**

2300 ST. PAUL STREET  
BALTIMORE, MARYLAND 21218

Division of Archeology  
(301) 554-5530

23 December 1986

Mr. Louis H. Ege, Jr.  
Deputy Director  
Division of Project Development  
State Highway Administration  
P.O. Box 717/707 North Calvert Street  
Baltimore, Maryland 21203-0717

RE: U.S. Route 29  
From I495, Montgomery County to  
U.S. 40, Howard County

Dear Mr. Ege:

I recently conducted a Phase I archeological reconnaissance of those areas currently considered for improvements of the Route 29 corridor in Montgomery and Howard counties. Most of 21.6 miles study involved proposed lane additions within narrow linear portions of already disturbed medians or along road berms. These areas did not require archeological survey. Consequently, the current survey consisted of areas proposed for interchanges, access roads and a relocation of U.S. Route 29 in the vicinity of Maryland Route 198.

The work consisted of background research and field reconnaissance. The background research included examining historic maps, site reports, and site files. Early structures were noted using the historic maps as a reference. Site reports were utilized to indicate portions of the project which had been surveyed previously. Site files provided information regarding known sites which had been recorded in the project area.

A total of 20 test loci were surveyed in the field over a course of several days (see attached map). Loci were selected on the basis of experience with site prediction models, and information gleaned from background research. Areas with good ground visibility were surface collected; otherwise shovel test pits were placed at 20-meter intervals in grass-covered or wooded areas. Given the rapid rate of development along U.S.

36

29 there were a number of areas not chosen for testing because of evident disturbances or lack of topographic integrity from construction-related activities. The following is a summary of what was accomplished:

Test Locus 1: (Lockwood Drive - Partial Interchange)

This locus appeared to be an undisturbed wooded hilltop on recent topographic maps. However, at the time of survey, it was being bulldozed for a proposed office building. Cleared ground was surface collected and trenches exposing stratigraphic layers were examined for cultural material. No archeological sites were located in this area.

Test Loci 2 (18MO271) and 3 (Stewart Lane - Partial Interchange)

Test Locus 2 was located in a level wooded area of the Dow Jones Chemical complex. Surface collection (no shovel test pits permitted) yielded 11 window glass fragments, 3 unidentified bottle glass fragments (1 etched), 1 bottle lip, 1 cut glass fragment, 1 whiteware sherd, 2 large quartzite flakes, and 1 small worked quartz flake. The historic component of this site may represent a dwelling noted on the 1879 atlas of Montgomery County as the Thomas Conley residences located on the opposite side of the present highway. The quartzite flakes may represent a portion of a small prehistoric encampment truncated by the construction of the Dow Jones Chemical parking lot, based on the locations of the representative artifacts.

Recommendations - Neither component of this site (18MO271) is recommended for additional work based on types, and locations of artifacts. The Conley house is either under the present highway or on the opposite side of the road and has been destroyed. The few prehistoric artifacts do not appear to be significant enough to warrant further testing.

No archeological material was found in any of the 4 shovel test pits placed along a level hilltop at Test Locus 3.

Test Locus 4 (Old Columbia Pike/Industrial Parkway turning bay)

Twenty-four shovel test pits placed across an expansive level grass-covered field located no cultural material, either prehistoric or historic.

Test Loci 5 (18MO272) and 6 (18MO273) (Interchanges at Randolph, Musgrove and Fairland Roads)

Shovel tests and surface collection at both loci located small prehistoric sites, representing small temporary camps. Surface collections at Test Locus 5 yielded 1 worked quartz chunk, 2 quartz flakes, 1 rhyolite secondary flake, and 1 oyster shell fragment, all located on a hilltop overlooking Route 29. No artifacts were found in 4 shovel tests placed on a grass-covered portion of the hilltop away from the highway. Test Locus 6 yielded 1 quartzite point fragment and 1 quartz chip on a large level ground exposed (40%) vegetable garden.

187

Recommendations - Neither site is recommended for addition work. Site 18MO272 was probably truncated by U.S. 29 and 18MO273 yielded a sparse amount of material. Thus, further investigation is not warranted.

Test Loci 7, 8 (18MO274), and 9 (Greencastle Road Interchange)

One prehistoric site (18MO274) located in a backyard vegetable garden of the Donna Newton residence at Test Locus 8 yielded 3 quartz biface fragments, 1 quartz biface, 9 quartz chunks, 2 quartz shatter, and 2 quartz secondary flakes as well as 1 rhyolite chunk in surface collection. Nine shovel test pits placed in a level wooded area at Test Locus 9 and surface collection of ground exposed areas of Test Locus 7 yielded no cultural material.

Recommendations - Because of the large amount of material found in a small area, site 18MO274 located at Test Locus 8 is recommended for additional work to determine site use, extent, cultural affiliation, integrity and its potential for inclusion to the National Register of Historic Places.

Test Loci 10 and 11 (Blackburn Road Full Interchange)

Surface collection in ground exposed areas (visibility 50-100%) yielded no cultural material either prehistoric or historic.

Test Loci 12, 13, and 14 (Realignment of U.S. 29 from Maryland Route 198 to Dustin Road)

Surface collection in a previously cultivated expansive level field covered in corn crop waste along with 7 shovel tests located no archeological material at Test Locus 13. Test Locus 12 was surface collected where it had been graded for development. No cultural material was found at this locus. Test Locus 14, a small hilltop located within SHA property boundaries was shovel tested to locate a possible historic site based on the presence of large trees and a driveway located near the hilltop. However, no cultural material was found in 7 shovel test pits.

Test Loci 15, 16, and 17 (Relocation of Old Columbia Road and Service Road A)

Four shovel test pits placed on a hilltop (Test Locus 15) proposed for access road A yielded no cultural material; seven shovel tests in an expansive level field along Route 29 proposed for median crossover (Test Locus 16) yielded no cultural material; as well, 4 shovel test pits along a small hilltop adjacent to the west side of U.S. 29 (Test Locus 17) yielded no cultural material.

Test Locus 18 (Service Road from Maryland 216)

Surface collection in an elongated field of corn crop waste along with 7 shovel test pits did not locate any archeological remains.

188

Test Locus 19 (18HO142) (Rivers Edge Road Underpass)

This test locus was shovel tested for prehistoric sites the entire length of a level wooded hilltop overlooking the Middle Patuxent River. Seven shovel test pits yielded no cultural material, either prehistoric or historic. However, a complex of foundation remains was located along with access roads leading to the complex from Old Columbia Road and U.S. 29. The foundations (3) appear to be of fairly recent construction (early 20<sup>th</sup> century) (cinderblock and stone). One shovel test pit placed near the stone foundation indicates that the area was used for a dump based on recent trash in the pit which consisted of glass bottle fragments oxidized metal fragments and ceramic sherds dating to the early to middle 20<sup>th</sup> century.

Recommendations - No additional work is recommended based on the late time period associated with this site.

Test Locus 20 (Service Road B at Gale Road)

Five shovel test pits placed in a small level wooded floodplain of an unnamed tributary failed to locate any archeological material.

As the result of the current survey, five archeological sites were located: 1 historic site (18HO142), 3 prehistoric (18MO272, 18MO273, and 18MO274) and 1 site (18MO27) with a prehistoric and a historic component.

Site 18MO274 is recommended for additional investigations to determine its eligibility for inclusion to the National Register. A study of the site may provide information regarding settlement patterns in the area and aboriginal subsistence. The remaining areas proposed for corridor improvements will not need additional work in their present design because of previous disturbance as the result of development.

A comprehensive report will follow shortly. In the meantime, if I can be of further assistance, please do not hesitate to contact me.

Sincerely,

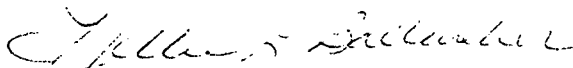

Hettie L. Ballweber  
Archeologist

HLB:lw

cc: Rita Suffness  
Cynthia D. Simpson

COMMISSIONERS

Jesse L. Maury  
Chairman  
Alexander Williams, Jr.  
Vice-Chairman  
Ada Koonce Blumenschein  
Robert M. Potter  
Leonard H. Teitelbaum  
Robert P. Will  
  
Richard G. Hocevar  
General Manager

169  
Washington Suburban  
Sanitary Commission

4017 Hamilton Street • Hyattsville, MD 20781 • 301 699-4000

TTY: 277-2314

206-2000  
RECEIVED

May 1, 1986

MAY 5 1986

GFC & C, INC.

Betty Bowers  
Environmental Manager  
Gannett Fleming  
Transportation Engineers, Inc.  
P.O. Box 1963  
Harrisburg, PA 17105

Dear Ms Bowers;

Thank you for alerting us to the proposed work on Route 29 in the  
Burtonsville area. Our greatest interest in the project will be how it impacts  
water quality and siltation in our Rocky Gorge raw water supply reservoir.  
We would appreciate the opportunity to review the site plans and sediment  
control plans for any area to be disturbed within our watershed in the vicinity  
of Route 29 Bridge over our reservoir.

Please forward the above information to Mr. John Corless, Water  
Operations Division Head, 6101 Sandy Spring Road, Laurel, MD 20707.

Yours truly,

Franklin E. Jamerson  
Acting Water Operations  
Division Head

FEJ/bre

cc: Bill Kennedy  
Mike Grear

190



Maryland Historical Trust

Aug 27 2 26 PM '86

PROJECT  
DEVELOPMENT  
DIVISION

August 20, 1986

Ms. Cynthia Simpson, Chief  
Environmental Management  
Maryland Dept. of Transportation  
State Highway Administration  
P. O. Box 717  
707 N. Calvert Street  
Baltimore, Maryland 21203-0717

RE: Contract HO 606-151-770  
U.S. Rt. 29  
from Sligo Cr. Pkwy. to U.S. 40

Dear Ms. Simpson:

In response to your letter of June 6, 1986, our office concurs in the possible NR eligibility and the proposed boundaries for the following properties:

- M 32/2 - Tax Parcel
- M 34/10 - Tax Parcel
- M 34/9 - Setting Outlined
- M 34/8 - Tax Parcel
- M 15/62 - Tax Parcel
- HO 269 - Setting Outlined
- HO 37 - Tax Parcel
- HO 154 - Tax Parcel
- HO 155 - Tax Parcel
- HO 430 - Tax Parcel
- HO 28 - Setting Outlined
- HO 87 - Tax Parcel.

We thank you for your cooperation.

Sincerely,

J. Rodney Little  
Director State Historic  
Preservation Officer

JRL/AHL/mmc  
CC: Mrs. Mary Louise Gramkow  
Mr. Ed Shull  
Ms. Mary Ann Kephart

Ms. Roberta Hahn  
Mr. Mark Walston, MNCPPC  
Ms. Rita Suffness

191

WETLANDS FIELD VIEW

U.S. ROUTE 29 IMPROVEMENT STUDY

DATE: October 1, 1986

ATTENDEES:

- Diane Eckles -- U.S. Fish and Wildlife Service
- M.Q. (Cas) Taherian -- MD DNR, Water Resources Administration
- Mike Hollins -- MD DNR, Coastal Resources
- Jonathan McKnight -- MD DNR, Forest Parks and Wildlife Service
- Bob Schueler -- MD DNR, Fisheries
- Sharon Preller -- MD SHA
- Wayne Willey -- Gannett Fleming
- Dave Willis -- Gannett Fleming
- Nancy Eagle -- Gannett Fleming

The phone number of those attending are listed on the attachment.

The purpose of the wetlands field view was to gain the USFWS and DNR input on the significance of impact on wetlands, and determine the need for replacement of impacted wetlands. Other mitigation suggestions from these agencies were also solicited.

Gannett Fleming provided a handout to be used as a guide during the field view. The handout included: mapping showing the location of wetlands, a table summarizing the nature of impacts created by each concept; and a sheet for each wetland where mitigation and other comments could be noted.

At each site a description of impacts (of each concept) was given, and USFWS and DNR provided suggestions on mitigation.

It was emphasized that not all of the alternates or concepts (within alternates) being studied would impact wetlands. Only those concepts noted on the impact summary page (for each county) of the handout would impact wetlands.

USFWS feels every impact on wetlands is significant, and all takings of wetlands would require 1:1 replacement. At first, it was stated that the replacement should be on site; but after noting the difficulty in accomplishing this (i.e., limited area), USFWS stated one large wetland could possibly be used to replace all takings of wetlands. The USFWS will make this determination after they have viewed all wetlands.

Six of the twelve wetlands in Howard County were viewed on this date. It was agreed that we would meet again on the earliest available date to finish Howard County. Then we would meet again to cover Montgomery County.

The following summarizes the mitigation suggestions and other comments received at each of the six wetlands:

WETLANDS REFERENCE #1

Little patuxent tributary at MD175 ramp (n.b. to U.S. 29)

NWI Classification: <sup>PSS1</sup> EM5

It was noted that the culvert would be extended a maximum of ten feet for Concept C-2.

192

USFWS suggested slopes of replacement wetlands be 1½:1

Fisheries Department noted it was a fairly good quality stream. Some minnows were seen. No anadremous fish.

Small animal tracks were noted in the culvert.

Replacement site adjacent to impacted wetland was considered, but this may not be possible due to limited available area. The other side of the ramp (south side) was also discussed. It was at this point that the possibility of one large wetland to collectively replace all impacts was suggested. USFWS and DNR would make this determination after looking at all wetlands.

WRA noted that during construction at ramp, silt fences or temporary berm also be used on opposite side of ramp (southside) to protect wetlands at this location.

It was noted by Fisheries Department that the existing box culvert was slightly higher than the water level and thus may act as a barrier to the fish. They suggest channels in culverts for low flow passage.

WRA suggested that all new culverts be dropped one foot below low flow.

WETLANDS REFERENCE #2

Little Patuxent tributary at Gales Lane

NWI Classification: PF01A

Concept C-2 would extend roadway to complete connection of Gales Lane. This concept would go through stream bed.

The stream bed was dry; rather deep (4 feet) in some areas.

The area was an old growth forest, containing many large trees (38 inch diameter poplars, etc.)

There was much detrital material; therefore, one of the functions is nutrient cycling.

USFWS position is to avoid this wetland, since you cannot really replace a mature palustrine, forested wetland.

WETLANDS REFERENCE #3A

Beaver Run at Seneca Drive, east of U.S. Route 29

NWI Classification: none, believed to be <sup>PSS1</sup>EH5

Concepts C-4 and C-5 require extending this existing culvert about 10 feet

Some stream relocation may be required for extending, since the stream bends at culvert.

Mayflies, stonefly, caddisfly, and minnows noted.



193

Fisheries Department noted that it was a viable stream with fairly good water quality. No anadromous fish. There was no impediment to fish movement through the culvert; natural stream bottom through culvert.

Fisheries is not too concerned about added length of culvert (i.e. believe fish get through existing culvert under U.S. 29) as long as stream bottom remains the same through the culvert.

It was suggested that erosion and sediment control measures be maximized and vegetation along banks be kept.

USFWS recommends 1½:1 slopes and retaining wall.

WETLANDS REFERENCE #3B

Beaver Run at Seneca Drive, west of U.S. Route 29

NWI Classification: none, believed to be PF01A

Concepts C-3 and C-4 require a new culvert approximately 150 feet upstream on Beaver Run. C-5 would require extending the existing culvert at Beaver Run.

USFWS prefers the tight ramps (C-5) -- extending the culvert.

USFWS recommends minimizing slopes and replacing loss. Would consider replacing in the field west of the stream.

WETLANDS REFERENCE #4

Three ponds east of U.S. Route 29 near Seneca Drive

NWI Classifications: POWZh, POWFh, POWZh

It was stated there is no direct impact on the ponds.

WETLANDS REFERENCE #5A

Middle Patuxent tributary east of U.S Route 29, south of Rivers Edge Road

Concepts C-3 and C-4 would place ramp through this area, culvert required.

USFWS and DNR, Coastal Resources, determined this area was not a wetland. This was based on vegetation and confirmed through auger samples.

The area was identified as a "mesic cove".

USFWS recommended that the shoulder of the roadway be kept as narrow as possible. They also recommended minimal clearing and making the side slopes 1½ to 1.

No replacement is required.

WETLANDS REFERENCE #5B

Middle Patuxent tributary east of U.S. Route 29, across from Rivers Edge Road

Concepts C-3 and C-4 require extending Rivers Edge road over this stream (culvert)

USFWS and DNR, Coastal Resources, determined this area was not a wetland.

Yellowboy was noted in the stream between 5A and 5B.

USFWS recommended taking out the existing concrete channel and restoring the riffle:pool ratio to that of upstream.

No replacement required.

WETLANDS REFERENCE #6

Middle Patuxent tributary at Rivers Edge Road

NWI Classification: none, believed to be PSS1A

Concepts C-3 and C-4 would require filling portions of this wetland and use of a long culvert and stream relocation.

It was determined this area was a wetland.

The stream is very degraded, containing yellowboy and concrete. The stream comes off a stormwater management area.

There is no room for mitigation on site.

DNR, Coastal Resources, said they would not argue if this area was filled and replaced elsewhere.

Other mitigation suggested was stream enhancement including adding limestone for acid drainage.

It was also suggested bridging stream (possibly wooden bridge) for ramps construction instead of using culverts.

We believe these minutes accurately reflect what transpired at the field view. However, we will appreciate comments involving a different understanding of what occurred.

NKE/rw

- cc: Attendees
- C. Simpson, SHA
- R. Aldrich, SHA
- B. Bowers, GFTE

Nancy H. Eagle

195

WETLANDS FIELD VIEW  
U.S. ROUTE 29 IMPROVEMENT STUDY  
HOWARD COUNTY (CONT'D)

DATE: October 20, 1986

ATTENDEES: Diane Eckles -- U.S. Fish and Wildlife Service  
M.Q. (Cas) Taherian -- MD DNR, Water Resources Administration  
Bob Schueler -- MD DNR, Fisheries  
Sharon Preller -- MD SHA  
Randy Aldrich -- MD SHA  
Nancy Eagle -- Gannett Fleming

The field view of wetlands in Howard County was continued from where it was ended on October 1, 1986.

The following summarizes the mitigation suggestions and other comments received on the remaining six wetlands.

WETLANDS REFERENCE #7

Middle Patuxent River (main branch) at U.S. Route 29

NWI Classification: P20WA & RF014; however area impacted under bridge is PSS1A

The two existing piers would be extended by all B and C Alternates to widen the bridge over the River for addition of a third northbound lane.

Approximately 240 SF of scrub/shrub wetlands on banks of River would be lost.

USFWS determined that replacement wetlands are not necessary. Vegetation will return if rip-rap is provided behind piers.

Other mitigation suggested was to place good size rip-rap behind piers for erosion control and confine construction, (ie, with sheet piling, for pier construction).

Erosion and sediment control should be strictly adhered to especially if the glassy darter is present in this area.

WETLANDS REFERENCE #8

Middle Patuxent tributary south of main branch

NWI Classification: PF01A

All C concepts would require relocation of about 600 feet of this stream for construction of Service Road.

USFWS determined this area is not a wetland; it is a mesic cove.

USFWS voiced opposition to disturbing this area for access for 5 or 6 driveways. It was stated that other alternatives should be considered to avoid this area, or justification must be strong for disturbance.

WETLANDS REFERENCE #9A

Hammond Branch between Hammond Drive and Hammond Parkway.

NWI Classification: PF01A

USFWS noted that an emergent area is also present on the north side of Hammond Branch.

Concept C-2 would extend Hammond Drive to Hammond Parkway over Hammond Branch by means of a box culvert. Approximately 0.4 acres of wetlands would be taken.

USFWS and DNR would like to see a bottomless culvert used at this location because it is a good quality stream.

WETLANDS REFERENCE #9B

Wetland area northwest of 9A, off of Hammond Parkway

NWI Classification: PF01A

This area may be impacted by C-2 if new driveway at this location is not kept tight against back yards of home on Gavin Way.

Vegetation and soils indicate this area is a wetland.

USFWS recommended building a driveway as close to property line, which would significantly reduce impacts on wetlands.

WETLANDS REFERENCE #10

Hammond Branch tributary at Crest Road.

This area will not be impacted by our project. The connection at the southern end of Crest Road (near MD 216) is part of a county project.

WETLANDS REFERENCE #11

Patuxent River tributary east of U.S Route 29 near Old Columbia Road.

NWI Classification: PF01A

USFWS determined that this area is not a wetland from soils and vegetation at this site.

USFWS favors an alternative that avoids this area, because of stream and floodplain, even though wetlands are not present.

WETLANDS REFERENCE #12

Patuxent River tributary north of Harding Road, near Golf Driving Range and farm.

NWI Classification: none, believed to be PF01A

197

USFWS determined this are is not a wetland. It is a small drainage area through a farming operation.

*Nancy Eagle*  
Submitted by Nancy Eagle

NKE/rw

APPENDIX - TRAFFIC DATA

The following figures and tables present the existing and future traffic data and level of service for the project area. The data from these tables is referenced and summarized in Section II.C. -- Existing and Projected Traffic Conditions. The figures and tables are listed below.

	<u>Page</u>
<u>Figures</u>	
1. 1985 ADT, A.M. Peak and P.M. Peak Traffic Volumes	VI-3
2. 2015 ADT, A.M. Peak and P.M. Peak Traffic Volumes	VI-11
<u>Tables</u>	
1. Howard County Intersection Level of Service	VI-18
2. Capacity Analysis for Old Columbia Road - Concept VI-C-1 Freeway Segment, Ramp, Weave	VI-19
3. Capacity Analysis for Old Columbia Road - Concept VI-C-2 Freeway Segment, Intersection	VI-20
4. Capacity Analysis for Old Columbia Road - Concept VI-C-3 Freeway Segment	VI-20
5. Capacity Analysis for Hammond - Hillcrest - Concept VI-C-1 Freeway Segment, Ramp, Weave	VI-21
6. Capacity Analysis for Hammond - Hillcrest - Concept VI-C-2 Freeway Segment	VI-22
7. Capacity Analysis for Hammond - Hillcrest - Concept VI-C-3 Freeway Segment	VI-22
8. Capacity Analysis for Hopkins-Gorman Road - Concept VI-C-1 Freeway Segment, Ramp, Intersection, Weave	VI-23
9. Capacity Analysis for Rivers Edge Road - Concept VII-C-3 Freeway Segment, Ramp, Intersection, Weave	VI-25
10. Capacity Analysis for Rivers Edge Road - Concept VII-C-4 Freeway Segment, Ramp, Intersection, Weave	VI-27
11. Capacity Analysis for Seneca Drive - Concept VIII-C-3 Freeway Segment, Ramp, Intersection, Weave	VI-29
12. Capacity Analysis for Seneca Drive - Concept VIII-C-4 Freeway Segment, Ramp, Intersection, Weave	VI-31
13. Capacity Analysis for Seneca Drive - Concept VIII-C-5, 5a, and 5b Freeway Segment, Ramp, Intersection, Weave	VI-33

199

Tables (cont'd)

Page

14.	Capacity Analysis for Gales Lane - Concept VIII-C-1 Freeway Segment, Ramp	VI-34
15.	Capacity Analysis for Gales Lane - Concept VIII-C-2 Freeway Segment	VI-35
16.	Capacity Analysis for Old Columbia Road - Concept IX-C-1 Freeway Segment, Ramp, Weave	VI-36
17.	Capacity Analysis for Old Columbia Road - Concept IX-C-2 Freeway Segment	VI-37
18.	Capacity Analysis for Pepple - Diamondback - Concept IX-C-1 Freeway Segment, Ramp, Weave	VI-38
19.	Capacity Analysis for Pepple - Diamondback - Concept IX-C-3 Freeway Segment	VI-39
20.	Capacity Analysis for Spring Valley Road - Concept X-C-2 Freeway Segment	VI-39

200

FIGURE 1  
1985 ADT, A.M. and P.M. PEAK  
TRAFFIC VOLUMES



26150	8400	37850	4300	35000
US	40			
8650	55400	21600		
	42100	12500		
	MD 103	*		
5800	750	5900	60	9100
ST JOHN S	3200	4000		
	49300			
	US 29			
	MD 987	4000		
	53300	1600		
	MD 982			
	53300			

220	150	2092	25	1915		16
1795	730	610	2020	350		1765
225	260		*			
	175					
	825					
	695					

475	140	2092	90	2915		150	2915
1745	595	525	2095	350		2710	325
150			*				

# 1985 ADT

# AM - PEAKS - PM

DAY STATISTICS

202

	53300			
		700		
		SPRING VALLEY RD 2200		
		1500		
	54100			
		6800	8700	
14100	MD	108		18700
		3100	5800	
	47500			
		250		
		DIAMOND BACK RD 500		
		250		
	47500			
		100		
		PEPPLE 600		
		500		
	47900			
		14900	9300	
34100	MD	175		31600
		2200	5300	
	31200			

		2665		
		10		
		30		
		1735		
		20		
		220	2035	
		500		
		290	240	
		8		
		70	1170	
		185		
		2210		
		5		
		20		
		1405		
		10		
		2235		
		5		
		20		
		30		
		1395		
		10		
		685	1270	
		310		
		275		
		640		
		225		
		250		
		625		
		130		
		25	880	
		120		

		2310		
		35		
		25		
		2730		
		100		
		325	1690	
		380		
		25	160	
		15		
		145	2005	
		190		
		1970		
		15		
		20		
		2320		
		30		
		2000		
		15		
		20		
		10		
		2340		
		30		
		580	1120	
		305		
		305		
		105		
		165		
		130		
		675		
		100		
		1310		
		240		

MARYLAND STATE HIGHWAY ADMINISTRATION — BUREAU OF HIGHWAY STATISTICS  
**1985 ADT** **AM > PEAKS > PM**

263

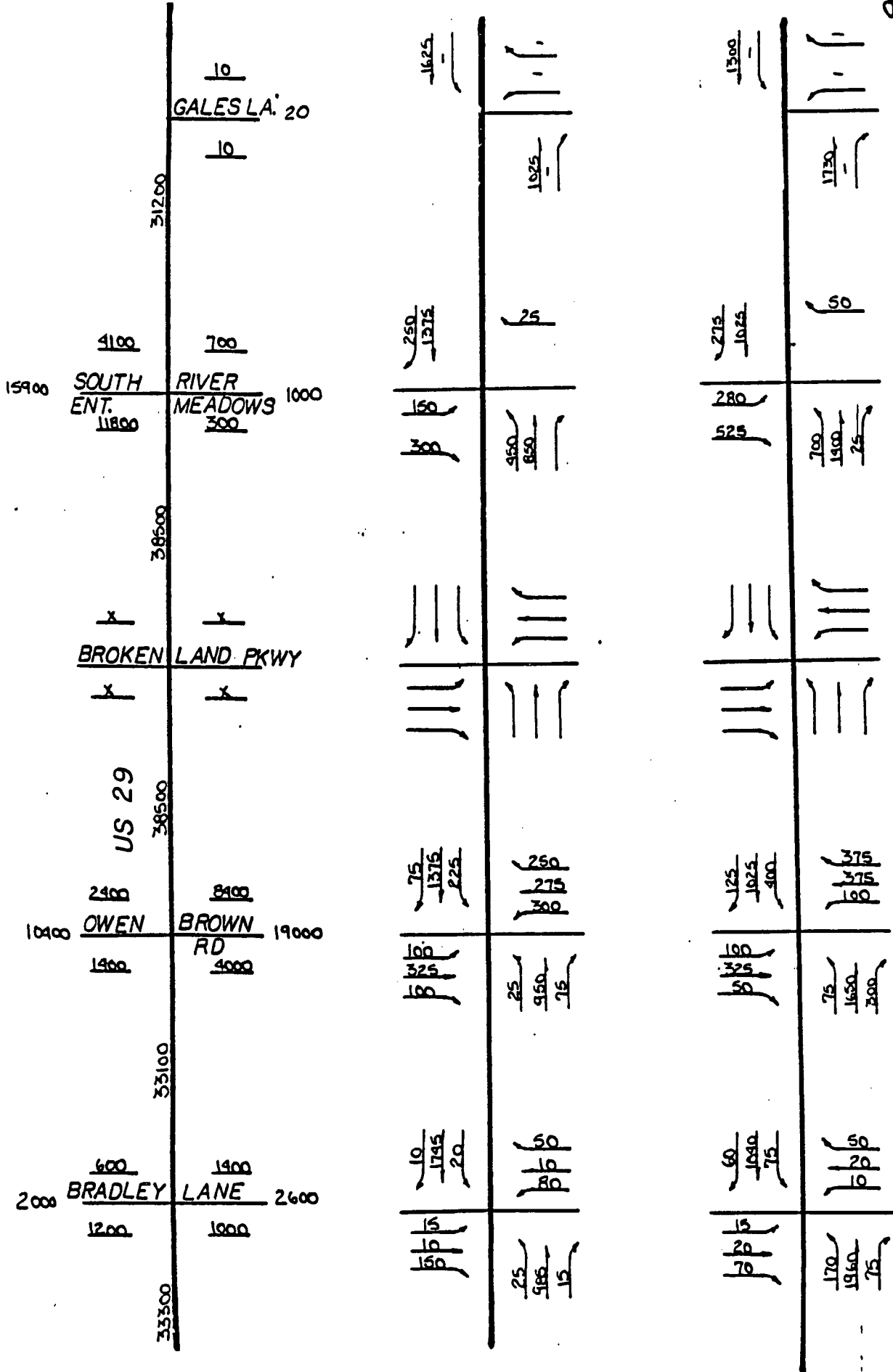

MARYLAND STATE HIGHWAY ADMINISTRATION — BUREAU OF HIGHWAY STATISTICS  
**1985 ADT**      **AM** > **PEAKS** > **PM**

204

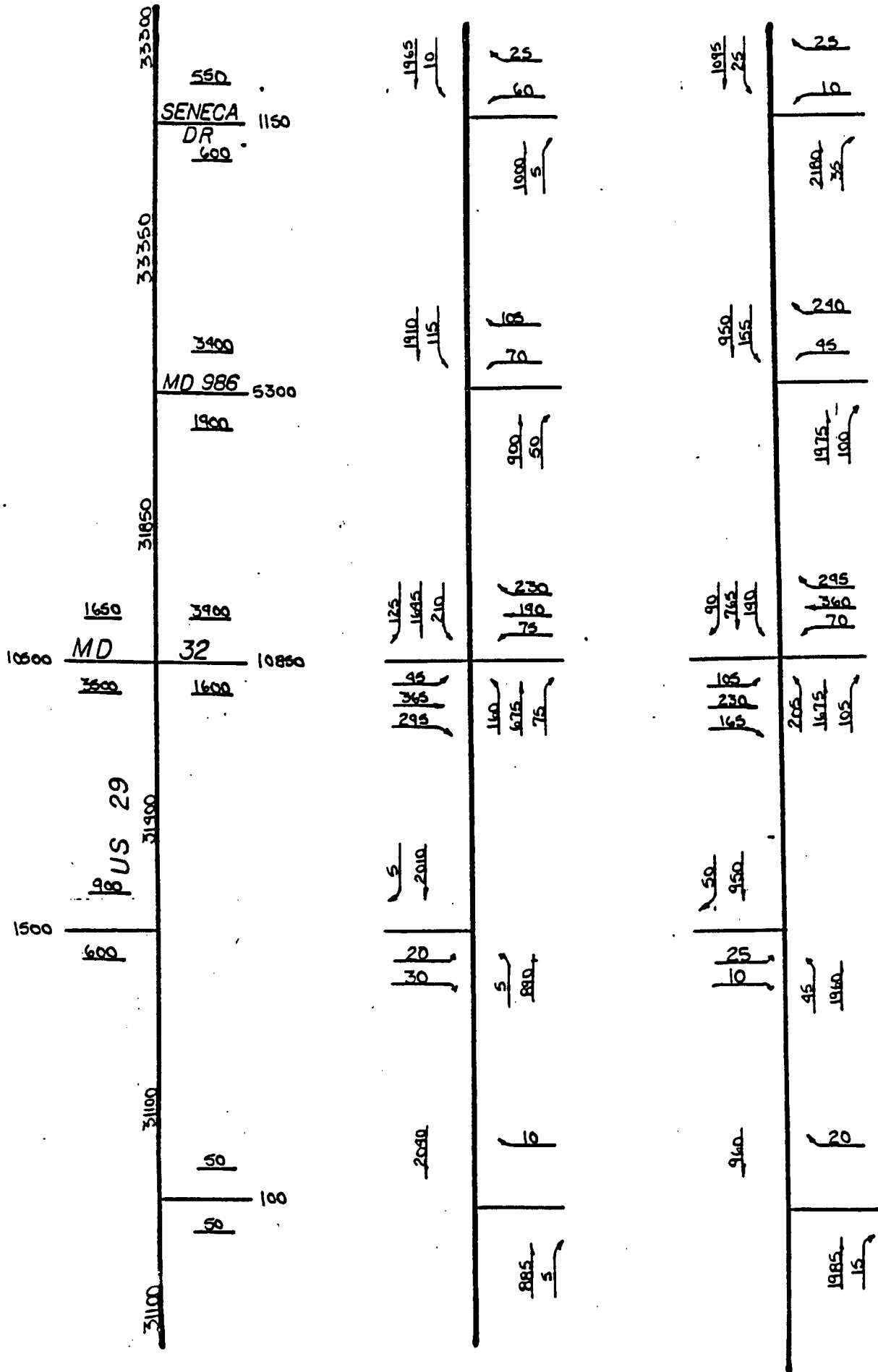

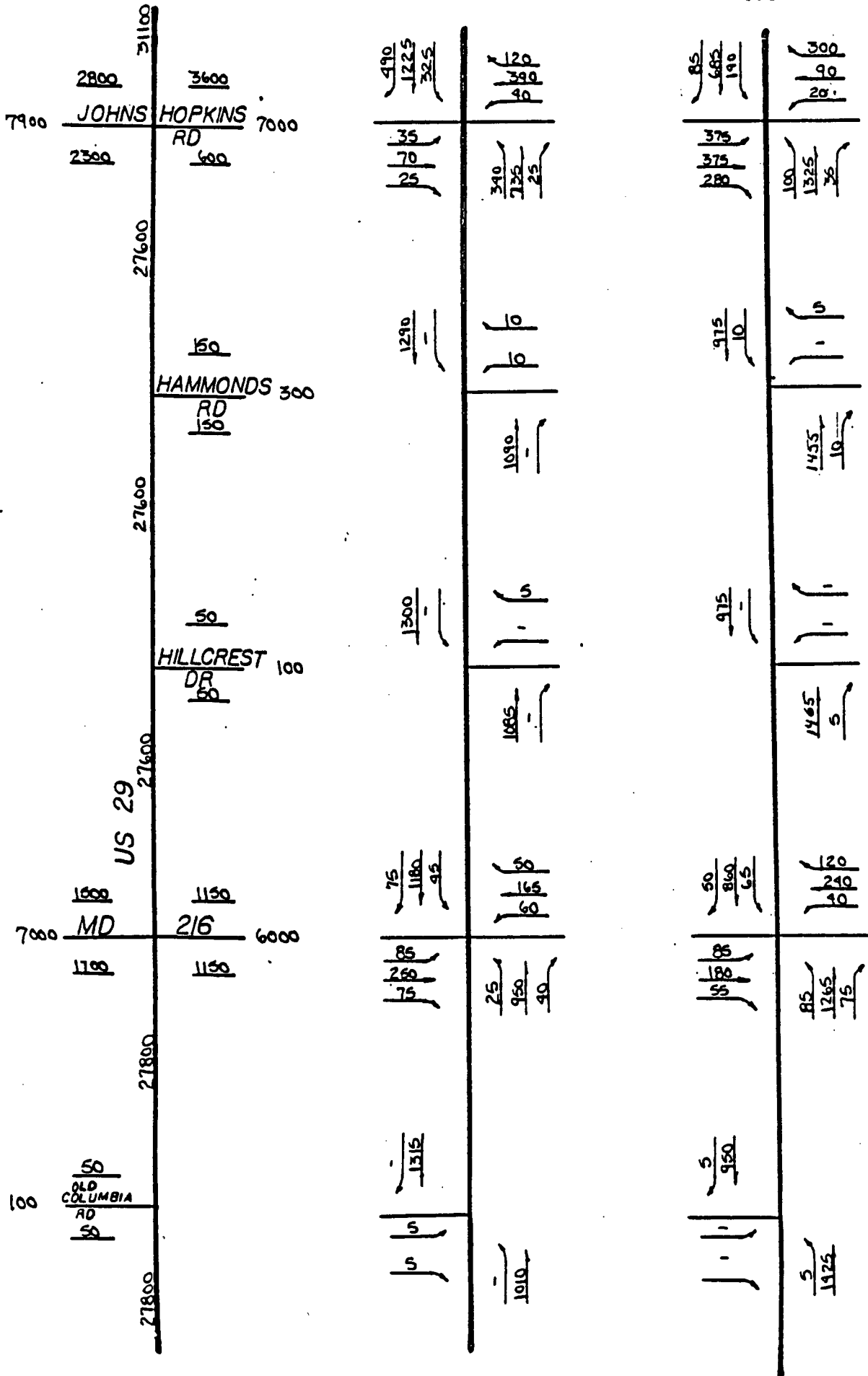

205

MARYLAND STATE HIGHWAY ADMINISTRATION — BUREAU OF HIGHWAY STATISTICS  
**1985 ADT** **AM < PEAKS > PM**

206

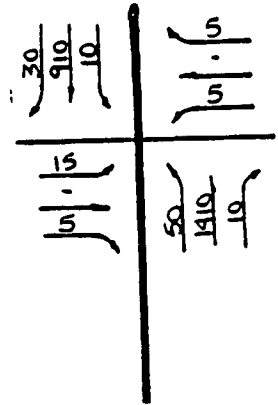
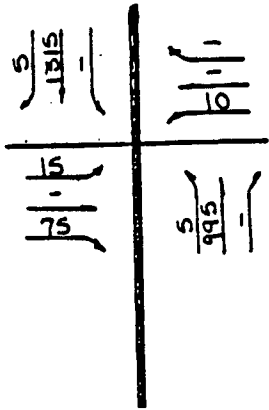
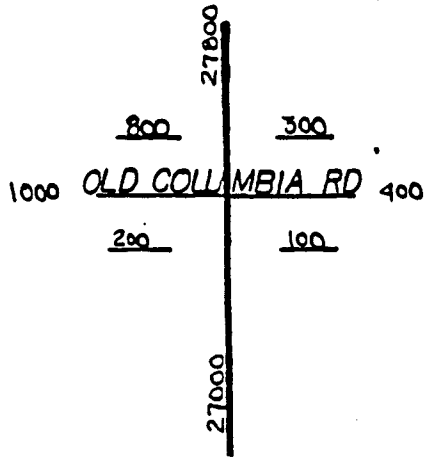

FIGURE 2  
2015 ADT, A.M. and P.M. PEAK  
TRAFFIC VOLUMES

2015 ADT

AM - PEAKS - PM

81300		
13400	7100	
50300	40	65900
19100	40400	
119700		
	31100	
	MD 103	31100
	*	
88600		
1050	5550	
9900	ST JOHN S LA.	16300
5300	7200	
US 29	94500	
	*	
	MD 987	7200
	7200	
	101700	
1900	MD 982.	
1900		
103600		

$\frac{445}{3235}$	$\frac{265}{610}$
$\frac{260}{1250}$	$\frac{340}{1730}$
$\frac{3840}{7070}$	$\frac{615}{*}$
$\frac{50}{3790}$	$\frac{70}{405}$
$\frac{65}{215}$	$\frac{210}{2765}$
$\frac{4405}{*}$	$\frac{2975}{620}$
$\frac{4405}{*}$	$\frac{3575}{*}$

$\frac{210}{2335}$	$\frac{455}{1085}$
$\frac{480}{1120}$	$\frac{695}{3195}$
$\frac{5440}{640}$	$\frac{1225}{*}$
$\frac{65}{3975}$	$\frac{355}{645}$
$\frac{35}{150}$	$\frac{330}{3780}$
$\frac{4170}{*}$	$\frac{4110}{675}$
$\frac{4170}{*}$	$\frac{4685}{*}$

200

2

3

4

5



2015 ADT

AM - PEAKS - PM

209 (2)

103600									
	<u>1650</u>								
	SPRING VALLEY RD 4100								
	<u>2450</u>								
104400									
	<u>14900</u>	<u>14900</u>							
32600	MD 108	39000							
	<u>5300</u>	<u>11700</u>							
91600									
	<u>350</u>								
	DIAMOND BACK RD 700								
	<u>350</u>								
US 29	91600								
	<u>250</u>								
	PEPPLE 1000								
	<u>750</u>								
92100									
	<u>19650</u>	<u>18250</u>							
43700	MD 175	45300							
	<u>3400</u>	<u>6400</u>							
64000									

6 ✓

7 -

8 ✓

9 ✓

10 -

# 2015 ADT

# AM - PEAKS - PM

2110

③

64000	<u>20</u>		
	GALES LA. 40		
	<u>20</u>		
64000			
<u>7500</u>	<u>1000</u>		
30000 SOUTH RIVER	RIVER MEADOWS 1500		
ENT. 27,500	<u>50</u>		
78500			
*	*		
BROKEN LAND PKWY			
*	*		
US 29	78500		
<u>4900</u>	<u>14000</u>		
20400 OWEN BROWN	RD 33000		
<u>3500</u>	<u>7000</u>		
70100			
<u>1350</u>	<u>2850</u>		
3100 BRADLEY LANE	4500		
<u>1500</u>	<u>1400</u>		
68800			

<u>3225</u>			
<u>2900</u>	<u>25</u>		
200	945	<u>710</u>	
<u>630</u>			
<u>3330</u>			
<u>3350</u>			
<u>2355</u>			
<u>115</u>	<u>2990</u>	<u>440</u>	
	<u>105</u>	<u>385</u>	
		<u>515</u>	
<u>210</u>	<u>510</u>	<u>80</u>	
	<u>260</u>	<u>1705</u>	
		<u>115</u>	
<u>75</u>	<u>3320</u>	<u>95</u>	
	<u>740</u>	<u>10</u>	
		<u>125</u>	
<u>10</u>	<u>105</u>	<u>95</u>	
		<u>1865</u>	
		<u>435</u>	

<u>1930</u>			
<u>210</u>	<u>1720</u>	<u>60</u>	
330	<u>460</u>		
<u>950</u>		<u>1190</u>	
		<u>2855</u>	
<u>2670</u>			
<u>270</u>	<u>1145</u>	<u>605</u>	
	<u>655</u>	<u>450</u>	
		<u>175</u>	
<u>220</u>	<u>510</u>	<u>290</u>	
	<u>95</u>	<u>3780</u>	
		<u>625</u>	
<u>15</u>	<u>1905</u>	<u>75</u>	
	<u>85</u>	<u>65</u>	
		<u>95</u>	
<u>25</u>	<u>10</u>	<u>70</u>	
		<u>3895</u>	
		<u>95</u>	

11 ✓  
12 ✓  
13 ✓  
14 ✓  
15 ✓

211

68800

500  
SENECA DR 900  
400

370  
40  
1925  
30

200  
45  
4025  
70

68700

475  
MD 986 900  
425

3675  
25  
1920  
25

1990  
45  
3980  
70

68650

11350 24850  
29850 MD 32 42500  
10100 9250

670  
2035  
985  
415  
740  
365  
330  
985  
460

525  
820  
660  
735  
585  
425  
485  
2270  
335

US 29

51800

2350

25  
2620

175  
1690

4475  
2125  
RIVERS EDGE DR.

200  
25  
175  
1375

26  
15  
250  
2830

51575

25  
OLD COLUMBIA RD. 275  
250

2675  
1760  
25

1865  
3080  
70

51800

16 ✓  
17 ✓  
18 ✓  
19 ✓  
20 ✓

2015 ADT

AM - PEAKS - PM

212

51800								
<u>4700</u>	<u>4600</u>		$\frac{525}{1700}$	$\frac{135}{600}$	$\frac{220}{1485}$	$\frac{445}{265}$		
14400	JOHNS HOPKINS RD	9300	$\frac{175}{165}$	$\frac{280}{465}$	$\frac{160}{585}$	$\frac{70}{2170}$		
<u>6300</u>	<u>1300</u>		$\frac{265}{230}$	$\frac{45}{1960}$	$\frac{425}{2130}$	$\frac{255}{2845}$		
50100								
	<u>225</u>		$\frac{15}{15}$	$\frac{15}{15}$	$\frac{10}{10}$	$\frac{5}{10}$		
	HAMMONDS RD	450						
	<u>225</u>			$\frac{1960}{19}$		$\frac{2845}{10}$		
50100								
	<u>50</u>		$\frac{2345}{x}$	$\frac{5}{x}$	$\frac{2140}{x}$	$\frac{10}{x}$		
	HILLCREST DR	100						
	<u>50</u>			$\frac{1970}{5}$		$\frac{2845}{5}$		
US 29								
	50100							
	<u>2150</u>	<u>6400</u>	$\frac{100}{2035}$	$\frac{325}{715}$	$\frac{75}{1660}$	$\frac{245}{415}$		
15600	MD	23000	$\frac{210}{240}$	$\frac{240}{240}$	$\frac{405}{225}$			
<u>2650</u>	<u>5800</u>		$\frac{105}{930}$	$\frac{120}{1485}$	$\frac{125}{670}$	$\frac{225}{2480}$		
	50000		$\frac{125}{6}$	$\frac{195}{2495}$	$\frac{165}{2045}$	$\frac{365}{2940}$		
100	MD COLUMBIA RD		$\frac{5}{5}$	$\frac{5}{1795}$	$\frac{5}{5}$	$\frac{5}{2940}$		
<u>50</u>	<u>50</u>							
50000								

21 -

22 ✓

23 ✓

24 -

25 ✓

MONTANA STATE HIGHWAY ADMINISTRATION — BUREAU OF HIGHWAY STATISTICS  
**2015 ADT** **AM < PEAKS > PM**

213 (6)

50000		
<u>1050</u>	<u>425</u>	
1350 OLD COLUMBIA RD 600		
<u>275</u>	<u>150</u>	
48950		

$\frac{70}{24/10}$	$\frac{5}{10}$
$\frac{16}{80}$	$\frac{5}{1780}$

$\frac{35}{2000}$	$\frac{25}{5}$
$\frac{40}{135}$	$\frac{60}{2880}$

26 ✓

214

TABLE 1 - HOWARD COUNTY INTERSECTION LEVEL OF SERVICE

Intersection	Level of Service (A.M./P.M. Peak Hours)		
	1985	2015	
	Existing Condition	Alternate A	Alternate B
U.S. 29 at Old Columbia Road (Sta. 657+)	A/A	D/F (1.06)	B/C
U.S. 29 at Hillcrest Drive	A/A	C/E	A/C
U.S. 29 at Hammond Drive	A/A	D/E	A/C
U.S. 29 at Johns Hopkins Road	C/D	F (1.25)/ F (1.38)	F(1.17)/ F(1.17)
U.S. 29 at Old Columbia Road	A/B	B/F (1.06)	B/C
U.S. 29 at Rivers Edge Road	B/A	F (1.14)/D	D/D
U.S. 29 at Seneca Drive	A/C	C/F (1.44)	A/F (1.06)
U.S. 29 at South Entrance	C/E	*	*
U.S. 29 at Gales Lane	A/A	F (1.11)/ F (1.12)	C/D
U.S. 29 at Pepple Drive	C/D	F (1.21)/ F (1.29)	D/E
U.S. 29 at Diamondback Drive	C/C	F (1.17)/ F (1.23)	D/E

Notes: Alternate A = No Build  
 Alternate B = Lane Widening  
 Level of Service Determination Based on 1985 MD SHA Critical Lane Analysis  
 \*Closed except for special events

215

TABLE 2 - CAPACITY ANALYSIS SUMMARY FOR OLD COLUMBIA ROAD - CONCEPT VI-C-1

Freeway Segment

	A.M. Peak		P.M. Peak	
	L.O.S.	No. of Lanes	L.O.S.	No. of Lanes
U.S. 29 N.B. South of Old Columbia Road	C	2	E	2
	C	3	C	3
U.S. 29 N.B. North of Old Columbia Road (w/Auxiliary Road)	C	2	D	2
	C	3	C	3
U.S. 29 S.B. North of Old Columbia Road (w/Auxiliary Lane)	C	2	C	2
	C	3	C	3
U.S. 29 S.B. South of Old Columbia Road	D	2	C	2
	C	3	C	3

Ramp

	A.M. Peak			P.M. Peak		
	Merge	Diverge	Ramp Proper	Merge	Diverge	Ramp Proper
N.B. U.S. 29 Exit Ramp	-	A	E	-	B	E
N.B. U.S. 29 Ent. Ramp (Auxiliary Lane)	A	-	C	A	-	C
S.B. U.S. 29 Exit Ramp (Auxiliary Lane)	-	A	E	-	A	E
S.B. U.S. 29 Ent. Ramp	A	-	C	A	-	C

Weave

	A.M. Peak		P.M. Peak	
	Weaving L.O.S.	Non-Weaving L.O.S.	Weaving L.O.S.	Non-Weaving L.O.S.
N.B. Weave between On Ramp at Old Columbia and Off Ramp at MD 216	A	A	A	A
S.B. Weave between On Ramp at MD 216 and Off Ramp at Old Columbia	B	A	A	A

TABLE 3 - CAPACITY ANALYSIS SUMMARY FOR OLD COLUMBIA ROAD - CONCEPT VI-C-2

Freeway Segment

	A.M. Peak		P.M. Peak	
	L.O.S.	No. of Lanes	L.O.S.	No. of Lanes
N.B. U.S. 29 at Old Columbia Road	C	2	E	2
	C	3	C	3
S.B. U.S. 29 at Old Columbia Road	C	2	C	2
	C	3	C	3

Intersection

	A.M. Peak	P.M. Peak
Old Columbia Road at Connection w/Stop Control	A	A

TABLE 4 - CAPACITY ANALYSIS SUMMARY FOR OLD COLUMBIA ROAD - CONCEPT VI-C-3

Freeway Segment

	A.M. Peak		P.M. Peak	
	L.O.S.	No. of Lanes	L.O.S.	No. of Lanes
N.B. U.S. 29 at Old Columbia Road	C	2	E	2
	C	3	C	3
S.B. U.S. 29 at Old Columbia Road	C	2	C	2
	C	3	C	3



217

TABLE 5 - CAPACITY ANALYSIS SUMMARY FOR HAMMOND-HILLCREST - CONCEPT VI-C-1

Freeway Segment

	A.M. Peak		P.M. Peak	
	L.O.S.	No. of Lanes	L.O.S.	No. of Lanes
N.B. U.S. 29 South of Hammond Drive (w/Auxiliary Lane)	C	2	D	2
	C	3	C	3
N.B. U.S. 29 North of Hammond Drive (w/Auxiliary Lane)	C	2	C	2
	C	3	C	3
S.B. U.S. 29 at Hammond Drive	C	2	C	2
	C	3	C	3

Ramp

	A.M. Peak			P.M. Peak		
	Merge	Diverge	Ramp Proper	Merge	Diverge	Ramp Proper
N.B. U.S. 29 Exit Ramp (Auxiliary Lane)	-	A	E	-	A	E
N.B. U.S. 29 Ent. Ramp	A	-	E	A	-	E

Weave

	A.M. Peak		P.M. Peak	
	Weaving L.O.S.	Non-Weaving L.O.S.	Weaving L.O.S.	Non-Weaving L.O.S.
N.B. Weave between On Ramp at MD 216 and Off Ramp at Hammond	B	B	B	A
N.B. Weave between On Ramp Hammond and Off Ramp at Hopkins-Gorman	A	A	B	B

2118

TABLE 6 - CAPACITY ANALYSIS SUMMARY FOR HAMMOND HILLCREST - CONCEPT VI-C-2

Freeway Segment

	A.M. Peak		P.M. Peak	
	L.O.S.	No. of Lanes	L.O.S.	No. of Lanes
N.B. U.S. 29 at Hammond Drive	C	2	D	2
	C	3	C	3
S.B. U.S. 29 at Hammond Drive	C	2	C	2
	C	3	C	3

TABLE 7 - CAPACITY ANALYSIS SUMMARY FOR HAMMOND HILLCREST - CONCEPT VI-C-3

Freeway Segment

	A.M. Peak		P.M. Peak	
	L.O.S.	No. of Lanes	L.O.S.	No. of Lanes
N.B. U.S. 29 at Hammond Drive	C	2	D	2
	C	3	C	3
S.B. U.S. 29 at Hammond Drive	C	2	C	2
	C	3	C	3

219

TABLE 8 - CAPACITY ANALYSIS SUMMARY FOR HOPKINS-GORMAN ROAD - CONCEPT VI-C-1

Freeway Segment

	A.M. Peak		P.M. Peak	
	L.O.S.	No. of Lanes	L.O.S.	No. of Lanes
N.B. U.S. 29 South of Hopkins-Gorman Road (w/Auxiliary Lane)	C	2	C	2
	C	3	C	3
N.B. U.S. 29 North of Hopkins-Gorman Road	C	2	E	2
	C	3	C	3
S.B. U.S. 29 North of Hopkins-Gorman Road	D	2	C	2
	C	3	C	3
S.B. U.S. 29 South of Hopkins-Gorman Road	C	2	C	2
	C	3	C	3

Ramp

	A.M. Peak			P.M. Peak		
	Merge	Diverge	Ramp Proper	Merge	Diverge	Ramp Proper
N.B. U.S. 29 Exit Ramp to Hopkins-Gorman Road	-	A	D	-	B	D
N.B. U.S. 29 Ent. Ramp from Hopkins-Gorman Road	A	-	B	D	-	C
S.B. U.S. 29 Exit Ramp to Hopkins-Gorman Road	-	B	B	-	C	C
S.B. U.S. 29 Ent. Ramp to Hopkins-Gorman Road	B	-	B	B	-	B

270

TABLE 8 - CONTINUED

Intersection

	A.M. Peak	P.M. Peak
S.B. Ramps at Hopkins-Gorman Road*	B	A
N.B. Ramps at Hopkins-Gorman Road*		
Single Lane S.B.	C	E
Separate Lanes S.B.	C	D
Relocate Hopkins-Gorman at Existing Gorman**		
Single Left Turn S.B.	F(1.03)	F(1.17)
Double Left Turn S.B.	D	D
Double Right Turn W.B.	C	E

\*Signal Control

\*\*Stop Control

Weave

	A.M. Peak		P.M. Peak	
	Weaving L.O.S.	Non-Weaving L.O.S.	Weaving L.O.S.	Non-Weaving L.O.S.
N.B. Weave between On Ramp at Hammond and Off Ramp at Hopkins-Gorman Road	A	A	B	B

TABLE 9 - CAPACITY ANALYSIS SUMMARY FOR RIVERS EDGE ROAD - CONCEPT VII-C-3

Freeway Segment

	A.M. Peak		P.M. Peak	
	L.O.S.	No. of Lanes	L.O.S.	No. of Lanes
N.B. U.S. 29 South of Old Columbia Road	C	2	E	2
	C	3	C	3
N.B. U.S. 29 North of Old Columbia Road (w/Auxiliary Lane)	C	2	D	2
	C	3	C	3
S.B. U.S. 29 North of Rivers Edge Road (w/Auxiliary Lane)	D	2	C	2
	C	3	C	3
S.B. U.S. 29 South of Rivers Edge Road	D	2	C	2
	C	3	C	3

Ramp

	A.M. Peak			P.M. Peak		
	Merge	Diverge	Ramp Proper	Merge	Diverge	Ramp Proper
N.B. U.S. 29 Exit Ramp	-	A	C	-	B	C
N.B. U.S. 29 Ent. Ramp	A	-	D	A	-	D
S.B. U.S. 29 Exit Ramp	-	A	C	-	A	C
S.B. U.S. 29 Ent. Ramp	B	-	C	A	-	C

Intersection\*

	A.M. Peak	P.M. Peak
N.B. U.S. 29 Ramps at Old Columbia Road	A	A
Rivers Edge Road at Old Columbia Road	A	A

\*All Intersections with Stop Control

222

TABLE 9 - CONTINUED

Weave

	A.M. Peak		P.M. Peak	
	Weaving L.O.S.	Non-Weaving L.O.S.	Weaving L.O.S.	Non-Weaving L.O.S.
N.B. Weave between On Ramp at Rivers Edge and Off Ramp at MD 32	A	B	A	A
S.B. Weave between On Ramp at MD 32 and Off Ramp at Rivers Edge	B	A	B	B

223

TABLE 10 - CAPACITY ANALYSIS SUMMARY FOR RIVERS EDGE ROAD - CONCEPT VII-C-4

Freeway Segment

	A.M. Peak		P.M. Peak	
	L.O.S.	No. of Lanes	L.O.S.	No. of Lanes
N.B. U.S. 29 South of Old Columbia Road	C	2	E	2
	C	3	C	3
N.B. U.S. 29 North of Old Columbia Road	C	2	D	2
	C	3	C	3
S.B. U.S. 29 North of Rivers Edge Road	D	2	C	2
	C	3	C	3
S.B. U.S. 29 South of Rivers Edge Road	D	2	C	2
	C	3	C	3

Ramp

	A.M. Peak			P.M. Peak		
	Merge	Diverge	Ramp Proper	Merge	Diverge	Ramp Proper
N.B. U.S. 29 Exit Ramp	-	A	C	-	B	C
N.B. U.S. 29 Ent. Ramp	A	-	D	A	-	D
S.B. U.S. 29 Exit Ramp	-	A	B	-	A	B
S.B. U.S. 29 Ent. Ramp	B	-	B	A	-	B

Intersection\*

	A.M. Peak	P.M. Peak
N.B. U.S. 29 Ramps at Old Columbia Road	A	A
Rivers Edge Road at Old Columbia Road	A	A
Rivers Edge Road at S.B. U.S. 29 Ramps	A	A

\*All Intersections with Stop Control

224

TABLE 10 - CONTINUED

Weave

	A.M. Peak		P.M. Peak	
	Weaving L.O.S.	Non-Weaving L.O.S.	Weaving L.O.S.	Non-Weaving L.O.S.
N.B. Weave between On Ramp at Rivers Edge and Off Ramp at MD 32	A	B	A	A
S.B. Weave between On Ramp at MD 32 and Off Ramp at Rivers Edge	B	B	C	B



225

TABLE 11 - CAPACITY ANALYSIS SUMMARY FOR SENECA DRIVE - CONCEPT VIII-C-3

Freeway Segment

	A.M. Peak		P.M. Peak	
	L.O.S.	No. of Lanes	L.O.S.	No. of Lanes
U.S. 29 N.B. South of Seneca Drive (No Auxiliary Lane)	C C	2 3	F D	2 3
U.S. 29 N.B. North of Seneca Drive (w/Auxiliary Lane)	C C	2 3	C C	2 3
U.S. 29 S.B. North of Seneca Drive (w/Auxiliary Lane)	F C	2 3	C C	2 3
U.S. 29 S.B. South of Seneca Drive	E C	2 3	C C	2 3

Ramp

	A.M. Peak			P.M. Peak		
	Merge	Diverge	Ramp Proper	Merge	Diverge	Ramp Proper
N.B. U.S. 29 Ent. Ramp	A	-	E	A	-	E
N.B. U.S. 29 Exit Ramp	-	A	D	-	A	D
S.B. U.S. 29 Exit Ramp	-	A	B	-	A	B
S.B. U.S. 29 Ent. Ramp	B	-	C	A	-	C

226

TABLE 11 - CONTINUED

Intersection

	A.M. Peak		P.M. Peak	
	L.O.S.	Type of Control	L.O.S.	Type of Control
Seneca Drive/Old Columbia Road/Service Road B	A	Stop	A	Stop
Seneca Drive/S.B. U.S. 29 Exit Ramp	A	Stop	A	Stop
Seneca Drive Ext./S.B. U.S. 29 Entrance Ramp	A	None	A	None
N.B. U.S. 29 Exit Ramp/Service Road B	A	Stop	A	Stop
N.B. U.S. 29 Entrance Ramp/Old Columbia Road	A	None	A	None

Weave

	A.M. Peak		P.M. Peak	
	Weaving L.O.S.	Non-Weaving L.O.S.	Weaving L.O.S.	Non-Weaving L.O.S.
Weave between N.B. Ramps	B	B	D	C
S.B. Weave between On Ramp at BrokenLand and Off Ramp at Seneca Drive	B	B	B	B
S.B. Weave between On Ramp at Seneca Drive and Off Ramp at MD 32	D	C	D	C

227

TABLE 12 - CAPACITY ANALYSIS SUMMARY FOR SENECA DRIVE - CONCEPT VIII-C-4

Freeway Segment

	A.M. Peak		P.M. Peak	
	L.O.S.	No. of Lanes	L.O.S.	No. of Lanes
U.S. 29 N.B. South of Seneca Drive (w/Auxiliary Lane)	C C	2 3	F D	2 3
U.S. 29 N.B. North of Seneca Drive (w/Auxiliary Lane)	C C	2 3	C C	2 3
U.S. 29 S.B. North of Seneca Drive (w/Auxiliary Lane)	F C	2 3	C C	2 3
U.S. 29 S.B. South of Seneca Drive (w/Auxiliary Lane)	E C	2 3	C C	2 3

Ramp

	A.M. Peak			P.M. Peak		
	Merge	Diverge	Ramp Proper	Merge	Diverge	Ramp Proper
N.B. U.S. 29 Exit Ramp	-	A	E	-	A	E
N.B. U.S. 29 Ent. Ramp	A	-	E	A	-	E
S.B. U.S. 29 Exit Ramp	-	A	B	-	A	B
S.B. U.S. 29 Ent. Ramp	A	-	B	A	-	B

278

TABLE 12 - CONTINUED

Intersection\*

	A.M. Peak	P.M. Peak
Exist. Seneca Drive/Old Columbia Road	A	A
Exist. Seneca Drive/Beechwood Drive	A	A
Exist. Seneca Drive/Seneca Drive Conn.	A	A
Seneca Drive Conn./S.B. Ramps	A	A

\*All Intersections with Stop Control

Weave

	A.M. Peak		P.M. Peak	
	Weaving L.O.S.	Non-Weaving L.O.S.	Weaving L.O.S.	Non-Weaving L.O.S.
N.B. Weave between On Ramp at MD 32 and Off Ramp at Seneca Drive	B	B	C	B
S.B. Weave between On Ramp at Seneca and Off Ramp at MD 32	E	D	D	C

TABLE 13 - CAPACITY ANALYSIS SUMMARY FOR SENECA DRIVE - CONCEPT VIII-C-5, 5a and 5b  
Freeway Segment

	A.M. Peak		P.M. Peak	
	L.O.S.	No. of Lanes	L.O.S.	No. of Lanes
U.S. 29 N.B. South of Seneca Drive (w/Auxiliary Lane)	C C	2 3	F D	2 3
U.S. 29 N.B. North of Seneca Drive (w/Auxiliary Lane)	C C	2 3	C C	2 3
U.S. 29 S.B. North of Seneca Drive (w/Auxiliary Lane)	F C	2 3	C C	2 3
U.S. 29 S.B. South of Seneca Drive (w/Auxiliary Lane)	E C	2 3	C C	2 3

Ramp

	A.M. Peak			P.M. Peak		
	Merge	Diverge	Ramp Proper	Merge	Diverge	Ramp Proper
N.B. U.S. 29 Exit Ramp	-	A	E	-	A	E
N.B. U.S. 29 Ent. Ramp	A	-	E	A	-	E
S.B. U.S. 29 Exit Ramp	-	A	B	-	A	B
S.B. U.S. 29 Ent. Ramp	A	-	B	A	-	B

Intersection\*

	A.M. Peak	P.M. Peak
N.B. Ramps/Service Road B	A	A
Seneca Drive/Old Columbia Road/Service Road B	A	A
Seneca Drive/S.B. Ramps	A	A

\*All Intersections with Stop Control

230

TABLE 13 - CONTINUED

Weave

	A.M. Peak		P.M. Peak	
	Weaving L.O.S.	Non-Weaving L.O.S.	Weaving L.O.S.	Non-Weaving L.O.S.
N.B. Weave between On Ramp at MD 32 and Off Ramp at Seneca Drive	B	B	C	B
S.B. Weave between On Ramp at Seneca and Off Ramp at MD 32	E	D	D	C

TABLE 14 - CAPACITY ANALYSIS SUMMARY FOR GALES LANE - CONCEPT VIII-C-1

Freeway Segment

	A.M. Peak		P.M. Peak	
	L.O.S.	No. of Lanes	L.O.S.	No. of Lanes
U.S. 29 N.B. South of Gales Lane	C	2	E	2
	C	3	C	3
U.S. 29 N.B. North of Gales Lane	C	2	E	2
	C	3	C	3
U.S. 29 S.B. at Gales Lane	E	2	C	2
	C	3	C	3

Ramp

	A.M. Peak			P.M. Peak		
	Merge	Diverge	Ramp Proper	Merge	Diverge	Ramp Proper
U.S. 29 N.B. Exit Ramp	-	A	E	-	B	E
U.S. 29 N.B. Ent. Ramp	A	-	E	B	-	E

231

TABLE 15 - CAPACITY ANALYSIS SUMMARY FOR GALES LANE - CONCEPT VIII-C-2

Freeway Segment

	A.M. Peak		P.M. Peak	
	L.O.S.	No. of Lanes	L.O.S.	No. of Lanes
U.S. 29 N.B. at Gales Lane	C	2	E	2
	C	3	C	3
U.S. 29 S.B. at Gales Lane	E	2	C	2
	C	3	C	3

232

TABLE 16 - CAPACITY ANALYSIS SUMMARY FOR OLD COLUMBIA ROAD - CONCEPT IX-C-1

Freeway Segment

	A.M. Peak		P.M. Peak	
	L.O.S.	No. of Lanes	L.O.S.	No. of Lanes
U.S. 29 N.B. South of Old Columbia Road	C	2	E	2
	C	3	C	3
U.S. 29 N.B. North of Old Columbia Road	C	2	E	2
	C	3	C	3
U.S. 29 S.B. at Old Columbia Road	E	2	C	2
	C	3	C	3

Ramp

	A.M. Peak			P.M. Peak		
	Merge	Diverge	Ramp Proper	Merge	Diverge	Ramp Proper
U.S. 29 N.B. Exit Ramp	-	A	E	-	A	E
U.S. 29 N.B. Ent. Ramp	A	-	E	B	-	E

Weave

	A.M. Peak		P.M. Peak	
	Weaving L.O.S.	Non-Weaving L.O.S.	Weaving L.O.S.	Non-Weaving L.O.S.
N.B. Weave between On Ramp at Old Columbia and Off Ramp at MD 175	A	A	B	B



TABLE 17 - CAPACITY ANALYSIS SUMMARY FOR OLD COLUMBIA ROAD - CONCEPT IX-C-2

Freeway Segment

	A.M. Peak		P.M. Peak	
	L.O.S.	No. of Lanes	L.O.S.	No. of Lanes
U.S. 29 N.B. North at Old Columbia Road	C	2	E	2
	C	3	C	3
U.S. 29 S.B. South at Old Columbia Road	E	2	C	2
	C	3	C	3

234

TABLE 18 - CAPACITY ANALYSIS SUMMARY FOR PEPPLA-DIAMONDBACK - CONCEPT IX-C-1  
 Freeway Segment

	A.M. Peak		P.M. Peak	
	L.O.S.	No. of Lanes	L.O.S.	No. of Lanes
U.S. 29 N.B. South of Diamondback Drive (w/Auxiliary Lane)	D	2	F	2
	C	3	C	3
U.S. 29 N.B. North of Diamondback Drive (w/Auxiliary Lane)	C	2	E	2
	C	3	C	3
U.S. 29 S.B. at Diamondback-Pepple (w/Auxiliary Lane)	C	2	C	2
	C	3	C	3

Ramp

	A.M. Peak			P.M. Peak		
	Merge	Diverge	Ramp Proper	Merge	Diverge	Ramp Proper
N.B. U.S. 29 Exit Ramp	-	A	E	-	A	E
S.B. U.S. 29 Ent. Ramp	A	-	E	A	-	E

Weave

	A.M. Peak		P.M. Peak	
	Weaving L.O.S.	Non-Weaving L.O.S.	Weaving L.O.S.	Non-Weaving L.O.S.
N.B. Weave between On Ramp at MD 175 and Off Ramp at Diamondback Drive	B	B	B	B
N.B. Weave between on Ramp at Diamondback and Off Ramp at MD 108	B	B	C	B

235

TABLE 19 - CAPACITY ANALYSIS SUMMARY FOR PEPPLA-DIAMONDBACK - CONCEPT IX-C-3

Freeway Segment

	A.M. Peak		P.M. Peak	
	L.O.S.	No. of Lanes	L.O.S.	No. of Lanes
N.B. U.S. 29 at Diamondback-Pepple	D	2	F	2
	C	3	C	3
S.B. U.S. 29 at Diamondback-Pepple (w/Auxiliary Lane)	C	2	C	2
	C	3	C	3

TABLE 20 - CAPACITY ANALYSIS SUMMARY FOR SPRING VALLEY ROAD - CONCEPT X-C-2

Freeway Segment

	A.M. Peak		P.M. Peak	
	L.O.S.	No. of Lanes	L.O.S.	No. of Lanes
U.S. 29 N.B. at Spring Valley Road (w/Auxiliary Lane)	D	2	F	2
	C	3	D	3
	C	4	C	4
U.S. 29 S.B. at Spring Valley Road	F	2	F	2
	E	3	D	3
	C	4	C	4

LITERATURE CITED

236

1. General Plan for Howard County, 1982. Office of Planning and Zoning. Ellicott City, Maryland. 1982.
2. "Urban Transportation Planning Package, 1980 Census", provided by Baltimore Regional Planning Council. May, 1986.
3. County and City Data Book, 1983. U.S. Department of Commerce, Bureau of the Census. 10th Edition. Washington, D.C. 1983.
4. "Water Resource Data, Maryland and Delaware, Water Year 1981." U.S. Geological Survey.
5. "Code of Maryland Regulations, (COMAR) 10.50.01", Maryland Receiving Water Quality Standards, Water Quality and Water Pollution Control. Department of Health and Mental Hygiene. December 31, 1985.
6. Howard County Water Sampling Data, 1978.
7. "Patuxent River Reservoir Water Quality Assessment" Washington Suburban Sanitary Commission. March, 1984.
8. "U.S. Route 29 Natural Environment Analysis From U.S. Route 40 to I-495 Howard and Montgomery Counties". Kidde Consultants, Inc., October 23, 1984.
9. The Water Resources of Howard and Montgomery Counties, Bulletin 14. Department of Geology, Mines, and Water Resources. State of Maryland, 1954.
10. "1983 Maryland Standards and Specifications for Soil Erosion and Sediment Control". Published jointly by Water Resources Administration, Soil Conservation Service, and State Soil Conservation Committee. April 1983.
11. "Maryland's Guidelines to Waterway Construction". Water Resources Administration. January, 1986.
12. Quality Criteria for Water. U.S. Environmental Protection Agency. 1976.

LITERATURE CITED

237

1. General Plan for Howard County, 1982. Office of Planning and Zoning. Ellicot City, Maryland. 1982.
2. "Urban Transportation Planning Package, 1980 Census", provided by Baltimore Regional Planning Council. May, 1986.
3. County and City Data Book, 1983. U.S. Department of Commerce, Bureau of the Census. 10th Edition. Washington, D.C. 1983.
4. "Water Resource Data, Maryland and Delaware, Water Year 1981." U.S. Geological Survey.
5. "Code of Maryland Regulations, (COMAR) 10.50.01", Maryland Receiving Water Quality Standards, Water Quality and Water Pollution Control. Department of Health and Mental Hygiene. December 31, 1985.
6. Howard County Water Sampling Data, 1978.
7. "Patuxent River Reservoir Water Quality Assessment" Washington Suburban Sanitary Commission. March, 1984.
8. "U.S. Route 29 Natural Environment Analysis From U.S. Route 40 to I-495 Howard and Montgomery Counties". Kidde Consultants, Inc., October 23, 1984.
9. The Water Resources of Howard and Montgomery Counties, Bulletin 14. Department of Geology, Mines, and Water Resources. State of Maryland, 1954.
10. "1983 Maryland Standards and Specifications for Soil Erosion and Sediment Control". Published jointly by Water Resources Administration, Soil Conservation Service, and State Soil Conservation Committee. April 1983.
11. "Maryland's Guidelines to Waterway Construction". Water Resources Administration. January, 1986.
12. Quality Criteria for Water. U.S. Environmental Protection Agency. 1976.